

NEW PRODUCTS

CATALOG



Tungaloy Accelerated Lines - Leading in Innovation



www.tungaloy.com





we improve...
we evolve...
we **ADD**



Tungaloy's Insights – Smart Manufacturing

Tungaloy, as one of the leaders in the metal removal industry, offers the latest innovations in grades and geometries for superb performance and tool life.

In a competitive world eager to embrace Industry 4.0, Tungaloy provides an extensive portfolio with the latest digital tools to support our customers in making better tooling decisions to improve their competitiveness and productivity.



Find all product
details in Tungaloy
updated e-catalog.





Tungaloy Accelerated Lines
Leading in Innovation



i n d e x

6 GRADE

10 GROOVING &
PARTING-OFF

12 AddForceCut

20 AddInternalCut

24 TungFeedBlade

28 TetraForce-Cut

32 DuoJust-Cut

40 TURNING

42 BoreMeister

52 TinyMiniTurn

60 MiniForceTurn /
WavyJoint CBN

64 ModuMiniTurn

78 MILLING

80 AddDoFeed

86 DoFeed

94 DoFeedTri

100 Tung-Tri

104 TungForce-Rec

112 DoMultiRec

116 TungMeister

138 HOLEMAKING

140 AddMeisterDrill

146 DrillMeister

166 Solid4FlutesDrill

170 ReamMeister



Grade

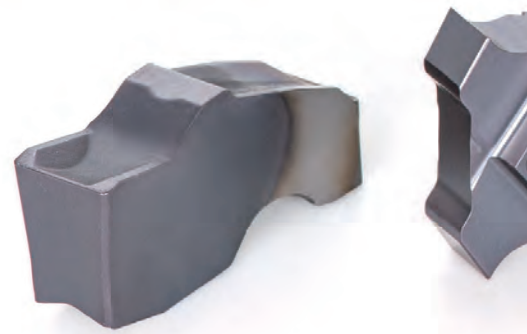

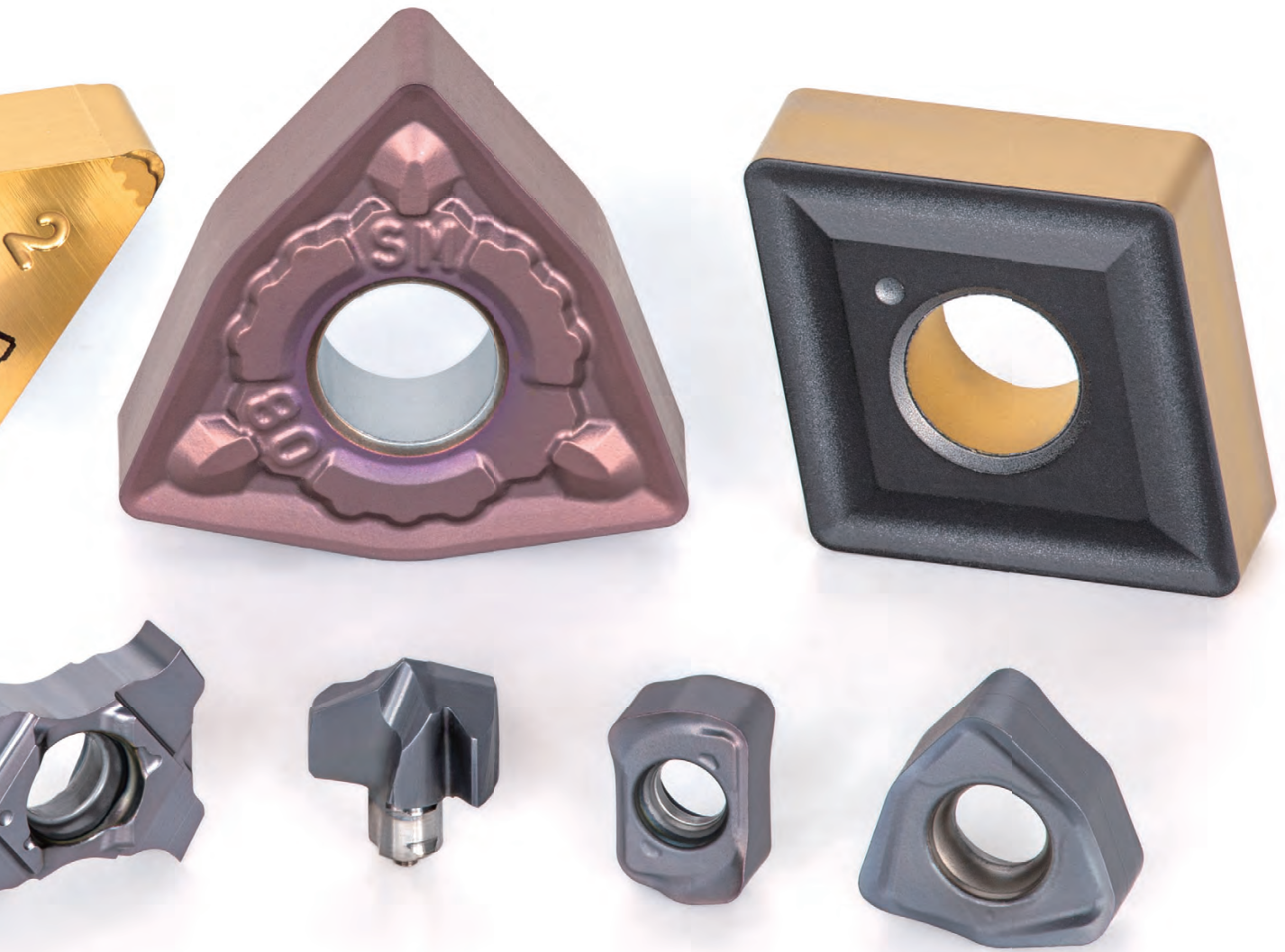

Grade

Coating CVD

Grade	Coating		Application	Feature	Turning	Grooving	Milling	Drilling
	Main composition	Thickness / μm						
New T6215 P10 - P30 M10 - M30	TiCN-Al ₂ O ₃	8	P M	- Demonstrates excellent wear resistance for high speed continuous stainless steel cuts				
T3225 P20 - P35 M20 - M35	TiCN-Al ₂ O ₃	10	P M	- High chipping and fracture resistance - Suitable for milling steel and stainless steel				
T1215 K10 - K25	TiCN-Al ₂ O ₃	10	K	- Good balance between wear and chipping resistance - Suitable for milling cast iron				
New T505 K05 - K20	TiCN + Al ₂ O ₃	23	K	- The best grade with high wear resistance for high speed machining of cast iron				

PVD

Grade	Coating		Application	Feature	Turning	Grooving	Milling	Drilling
	Main composition	Thickness / μm						
AH120 P15 - P25 M15 - M25 K15 - K30 S10 - S25	(Ti, Al)N	3	P M K S	- Good balance between wear and fracture resistance - Suitable for machining steel, stainless steel, and cast iron under general cutting conditions				
AH130 P25 - P40 M25 - M40	(Ti, Al)N	3	P M	- High chipping and fracture resistance - Designed for machining austenitic stainless steel under general cutting conditions				
New AH715 P15 - P30 M15 - M30	(Ti, Al)N	5	P M	- Ideal grade for end milling with the latest nano-multilayered PVD coating - Exclusive substrate with a good balance of wear and fracture resistance				
AH725 P15 - P30 M15 - M30 K25 - K30 S15 - S25	(Ti, Al)N	2	P M K S	- Good balance between wear and chipping resistance - Suitable for machining steel and stainless steel under general cutting conditions				
New AH6225 P20 - P30 M20 - M30	(TiAl)N-Ti(C,N)	5.5	P M	- First choice for stainless steel - Excellent versatility for stainless steel machining, demonstrates a good combination of wear and fracture resistance				
New AH6235 P30 - P40 M30 - M40	(TiAl)N-Ti(C,N)	5.5	P M	- Demonstrates superior fracture resistance in stainless steel - Provides high reliability for interrupted cuts and heavy-duty machining				
AH7025 P20 - P30 M20 - M30 S15 - S25	(Ti, Al)N	3.5	P M K S	- Excellent wear resistance and high rigidity - First choice for grooving of various materials				
AH750 H15 - H30	(Ti, Al)N	3	H	- High wear resistance - Designed for milling high-hardened material				
AH8005 M01 - M10 S01 - S10	(Al,Ti)N	3.5	M S H	- Good resistance to wear and adhesion - Excellent performance in machining heat-resistant alloy at high speed				
AH8015 M10 - M20 S10 - S20	(Al,Ti)N	3.5	P M K S H	- Good balance between wear and fracture resistance - First choice for machining heat-resistant alloy under general cutting conditions				
AH3225 P20 - P35 M20 - M35	(Ti, Al)N	5	P M	- Good balance between wear and fracture resistance - Suitable for steel and stainless steel				

PVD

Grade	Coating		Application	Feature	Turning	Grooving	Milling	Drilling
	Main composition	Thickness / μm						
AH3035 P20 - P45 H20 - H30	(Ti, Al)N	5	P H	- Good balance between wear and chipping resistance - Suitable for machining high-hardened steel at high feed				
AH9130 P15 - P35 M25 - M35 K10 - K25 S15 - S30	(Ti, Al)N	4.5	P M K S	- High wear resistance - Designed for drilling various materials				
SH725 P20 - P30 M20 - M30	(Ti, Al)N	2	P M N S	- High wear resistance - Designed for machining steel and stainless steel				
SH730 P20 - P35 M20 - M35 S05 - S15	(Ti, Al)N	1	P M S	- High wear resistance - Designed for machining steel, stainless steel, and difficult-to-cut material				

CBN

Grade	Hardness (Hv)	T.R.S. (GPa)	Application	Feature	Turning	Grooving	Milling	Drilling
BXA10	3200 ~ 3400	1.00 ~ 1.10	H	- Coated T-CBN for excellent performance in continuous cutting of hardened steel				
BXA20	3300 ~ 3500	1.30 ~ 1.50	H	- Coated T-CBN for excellent performance in machining hardened steel				

PCD (T-DIA)

Grade	Grain size (μm)	Hardness (Hv)	T.R.S. (GPa)	Application	Feature	Turning	Grooving	Milling	Drilling
DX110	< 1	8500	1.8	N	- Excellent sharpness for high surface quality - Suitable for finishing non-ferrous metal and nonmetal				

Uncoated Cemented Carbide

Grade	Hardness (HRA)	T.R.S. (GPa)	Application	Feature	Turning	Grooving	Milling	Drilling
KS05F K05 S05 N05	93	2.9	K S N	- Fine edge sharpness with high wear resistance - Outstanding tool life for machining of non-ferrous metals				
KS15F N15	91.5	3	N	- Good balance between wear resistance and toughness - Incredibly reliable in milling of non-ferrous metals				



Grooving & Parting-off

- 12 AddForceCut
- 20 AddInternalCut
- 24 TungFeedBlade
- 28 TetraForce-Cut
- 32 DuoJust-Cut



Ingersoll

QSG120-3T
9524343

ADD^{ORCE}FCUT

External grooving, Parting-off

SUPERB STABILITY AND PRODUCTIVITY IN DEEP GROOVING AND PARTING-OFF OPERATIONS

ADD highly rigid self-clamping system to improve productivity in deep grooving and parting-off operations

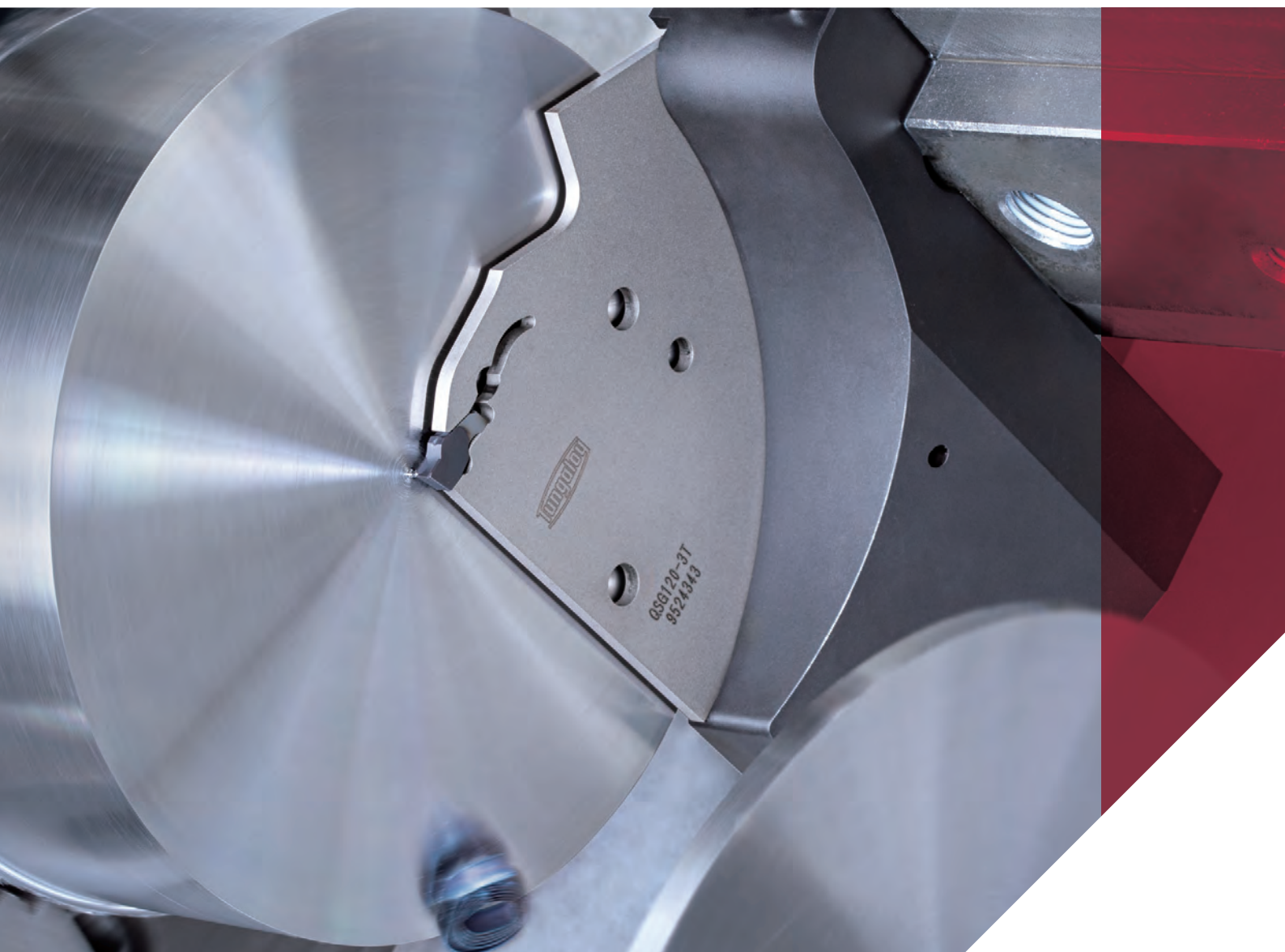



- Single-ended **ADDForceCut** insert features a smart self-locking design requiring no clamping screw to hold the insert. This enables deep grooving and parting-off operations of large-diameter bar stocks.
- The insert is locked at three positions with the use of an insert stopper in the pocket. This design provides extremely rigid insert clamping.
- Newly designed insert profile ensures unobstructed chip flow and consistent chip evacuation.

Lineup

Inserts

- **QGM...** and **QGS...**
- CW = 2, 3, 4, and 5 mm
- Max grooving depths (for monoblock shanks): CDX = 33 mm



Toolholders

- Monoblock shanks: **QSER/L...** in size 2020 and 2525
- Blades: **QSP...** and **QSG...**
- Blocks: **CTBU...** and **CHTBR/L...**
- ID grooving heads for **BoreMeister**: **S25-QSIR/L...** and **S32-QSIR/L...**

Grade

- **AH7025**: Dedicated grade for grooving applications featuring a good balance of wear and chipping resistance

Scan this QR code to find out more about this tool!



TOOLHOLDERS

QSER/L

External toolholders for grooving and parting

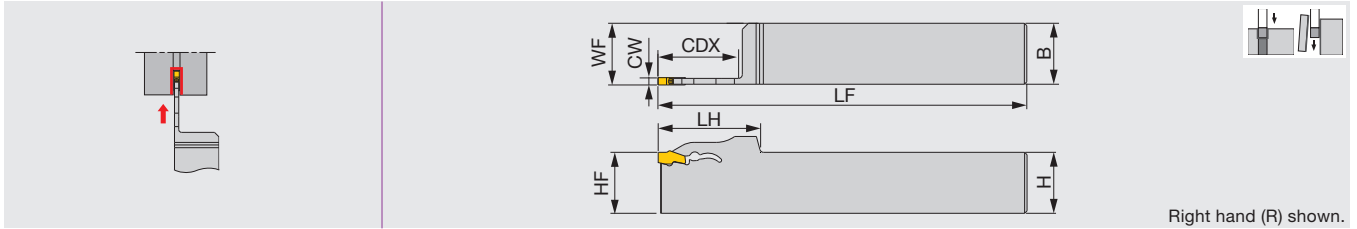

Right hand (R) shown.

Designation	CW	CDX	Seat size	H	B	LF	LH	HF	WF
QSER/L2020-2T26	2	26	2	20	20	125	36	20	20.1
QSER/L2020-2T33	2	33	2	20	20	125	42	20	20.1
QSER/L2525-2T26	2	26	2	25	25	150	36	25	25.1
QSER/L2525-2T33	2	33	2	25	25	150	42	25	25.1
QSER/L2020-3T26	3	26	3	20	20	125	36	20	20.3
QSER/L2020-3T33	3	33	3	20	20	125	42	20	20.3
QSER/L2525-3T26	3	26	3	25	25	150	36	25	25.3
QSER/L2525-3T33	3	33	3	25	25	150	42	25	25.3
QSER/L2020-4T33	4	33	4	20	20	125	42	20	20.4
QSER/L2525-4T33	4	33	4	25	25	150	42	25	25.4
QSER/L2525-5T33	5	33	5	25	25	150	42	25	25.5

MODULAR HEAD

S-QSIR/L-H

BOREMEISTER

Exchangeable boring head, for internal grooving

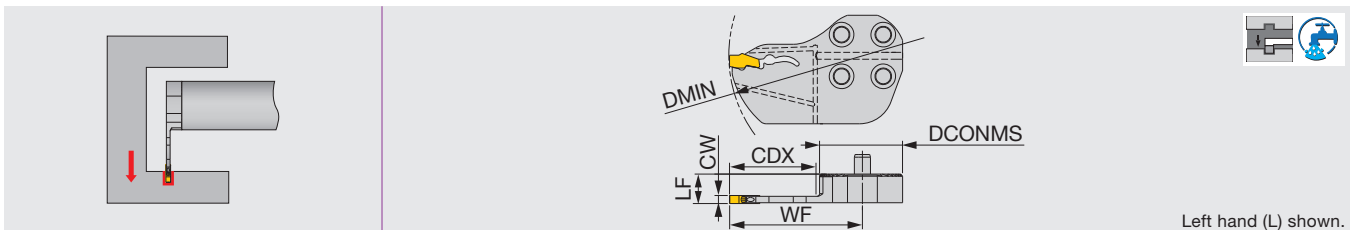

Left hand (L) shown.

Designation	CW	CDX	DMIN	DCONMS	Seat size	LF	WF	Shank
S25-QSIR/L2T26D550-H	2	26	55	25	2	8.5	40.1	D25
S25-QSIR/L3T26D550-H	3	26	55	25	3	9	40.1	D25
S32-QSIR/L3T32D700-H	3	32	70	32	3	11	49.6	D32
S32-QSIR/L4T32D700-H	4	32	70	32	4	11.5	49.6	D32

Please refer to the BoreMeister Tungaloy Report (TR517) for shank information that is applicable to the head.

BLADE

QSP

Blades for external deep grooving and parting

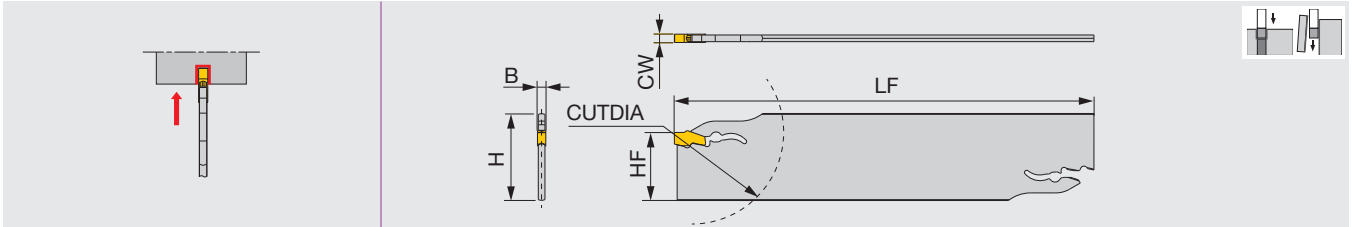

Designation	CW	CUTDIA	Seat size	H	B	LF	HF
QSP26-2D	2	50	2	26	1.8	150	21.1
QSP32-2D	2	66	2	32	1.8	150	24.5
QSP26-3D	3	75	3	26	2.4	150	21.1
QSP32-3D	3	120	3	32	2.4	150	24.5
QSP26-4D	4	80	4	26	3.2	150	21
QSP32-4D	4	120	4	32	3.2	150	24.4
QSP32-5D	5	120	5	32	4	150	24.4

TOOL BLOCK

CTBU

Tool block for QSP blades

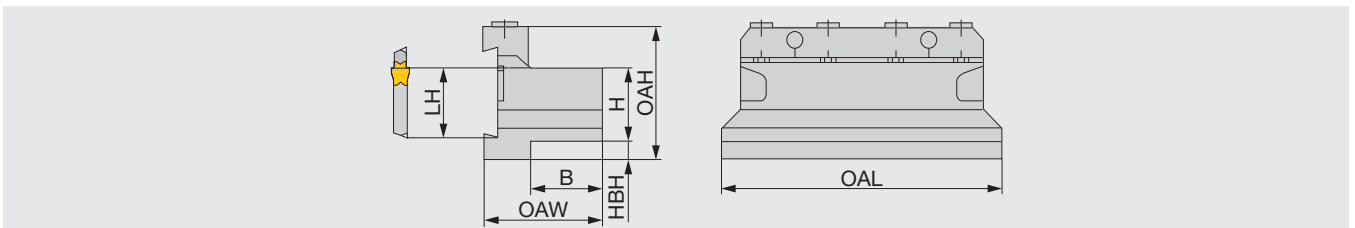

Designation	H	B	OAL	LH	HBH	OAH	OAW	Blade (Optional)
CTBU20-26	20	21	86	21.4	9	43	38	QSP26...
CTBU25-26	25	23	110	21.4	5	45	43	QSP26...
CTBU20-32	20	19	100	24.8	13	50	38	QSP32...
CTBU25-32	25	23	110	24.8	8	50	42	QSP32...
CTBU32-32	32	29	110	24.8	5	54	48	QSP32...

BLADE

QSG

Parting-off and external grooving blade

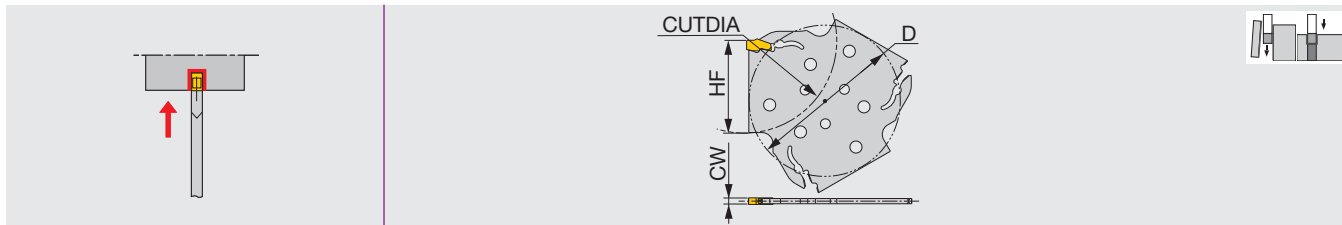

Designation	CW	Seat size	CUTDIA	HF	D
QSG52-2T	2	2	52	27	48.3
QSG82-2T	2	2	82	42	69.3
QSG52-3T	3	3	52	27	48.3
QSG82-3T	3	3	82	42	69.3
QSG120-3T	3	3	120	61	88
QSG52-4T	4	4	52	27	69.3
QSG82-4T	4	4	82	42	69.3
QSG120-4T	4	4	120	61	88
QSG120-5T	5	5	120	61	88

TOOL BLOCK

CHTBR/L

Tool block for QSG blade

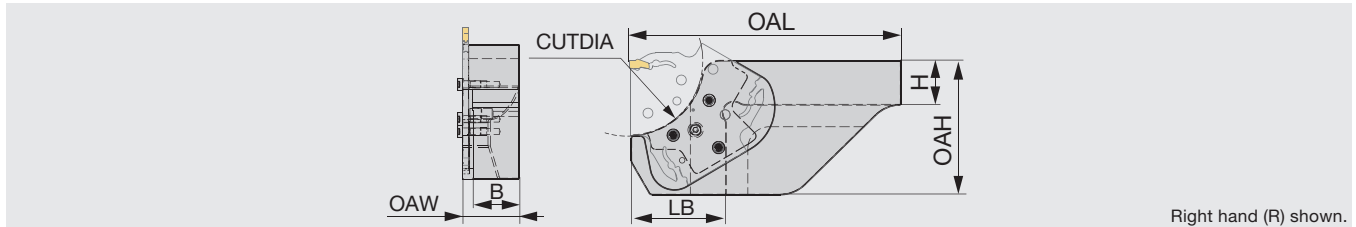

Right hand (R) shown.

Designation	CUTDIA	H	B	OAL	OAH	OAW	LB
CHTBR/L2020-52	52	20	20.5	100	50	26.5	37
CHTBR/L2525-52	52	25	25.5	125	50	31.5	37
CHTBR/L2020-82	82	20	20.5	140	75	26.5	53
CHTBR/L2525-82	82	25	25.5	150	75	31.5	53
CHTBR/L2525-120	120	25	25.5	165	100	31.5	67
CHTBR/L3232-120	120	32	32.5	165	100	38.5	67

The blade clamping screw heads protrude out for as much as 3.1 mm over the insert cutting edge point. Maintain the clearance from the chucking device to avoid interference.

Maximum groove depth : T max as function of workpiece diameter : ϕD_1

Designation	ϕD_1																	
CHTBR/L****-D52	53	54	55	56	58	60	62	65	68	72	78	84	92	102	115	133	159	198
CHTBR/L****-D82	104	108	112	116	121	127	134	142	151	162	176	192	212	237	270	313	375	468
CHTBR/L****-D120	205	214	224	235	247	261	278	297	319	345	376	414	462	522	601	709	865	1112
T max	21	20	19	18	17	16	15	14	13	12	11	10	9	8	7	6	5	4

Designation	ϕD_1												
CHTBR/L****-D82	83	84	84	85	86	87	89	90	92	94	96	98	101
CHTBR/L****-D120	144	147	150	153	156	160	164	168	173	178	184	190	197
T max	34	33	32	31	30	29	28	27	26	25	24	23	22

Designation	ϕD_1																
CHTBR/L****-D120	121	122	123	124	125	126	127	128	129	130	131	133	134	136	138	140	142
T max	55	52	50	48	47	46	45	44	43	42	41	40	39	38	37	36	35

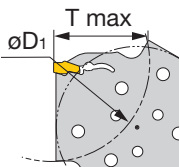

STANDARD CUTTING CONDITIONS

ISO	Workpiece material	Hardness	Grade	Cutting speed Vc (m/min)	Feed: <i>f</i> (mm/rev)	
					QGM	QGS
P	Steels C45, 34CrMo4, etc.	< 300 HB	AH7025	50 - 180	0.05 - 0.35	0.04 - 0.2
M	Stainless steel X10CrNiS18-9, etc.	< 200 HB	AH7025	50 - 120	0.05 - 0.35	0.04 - 0.2
K	Gray cast iron GG25, 250, etc.	-	AH7025	50 - 180	0.05 - 0.35	0.04 - 0.2
	Ductile cast irons GGG45, 450-10S, etc.	-	AH7025	50 - 120	0.05 - 0.35	0.04 - 0.2
S	Superalloys Inconel718, etc.	< HRC 40	AH7025	20 - 60	0.05 - 0.35	0.04 - 0.2
	Titanium alloys Ti-6Al-4V, etc.	< HRC 40	AH7025	20 - 80	0.05 - 0.35	0.04 - 0.2

ADD^{INTERNAL}CUT

Internal grooving

UNIQUE 4-EDGED INSERT FOR SMALL INTERNAL GROOVING OPERATIONS

ADD stability and repeatability in small internal grooving operations with the unique insert clamping system

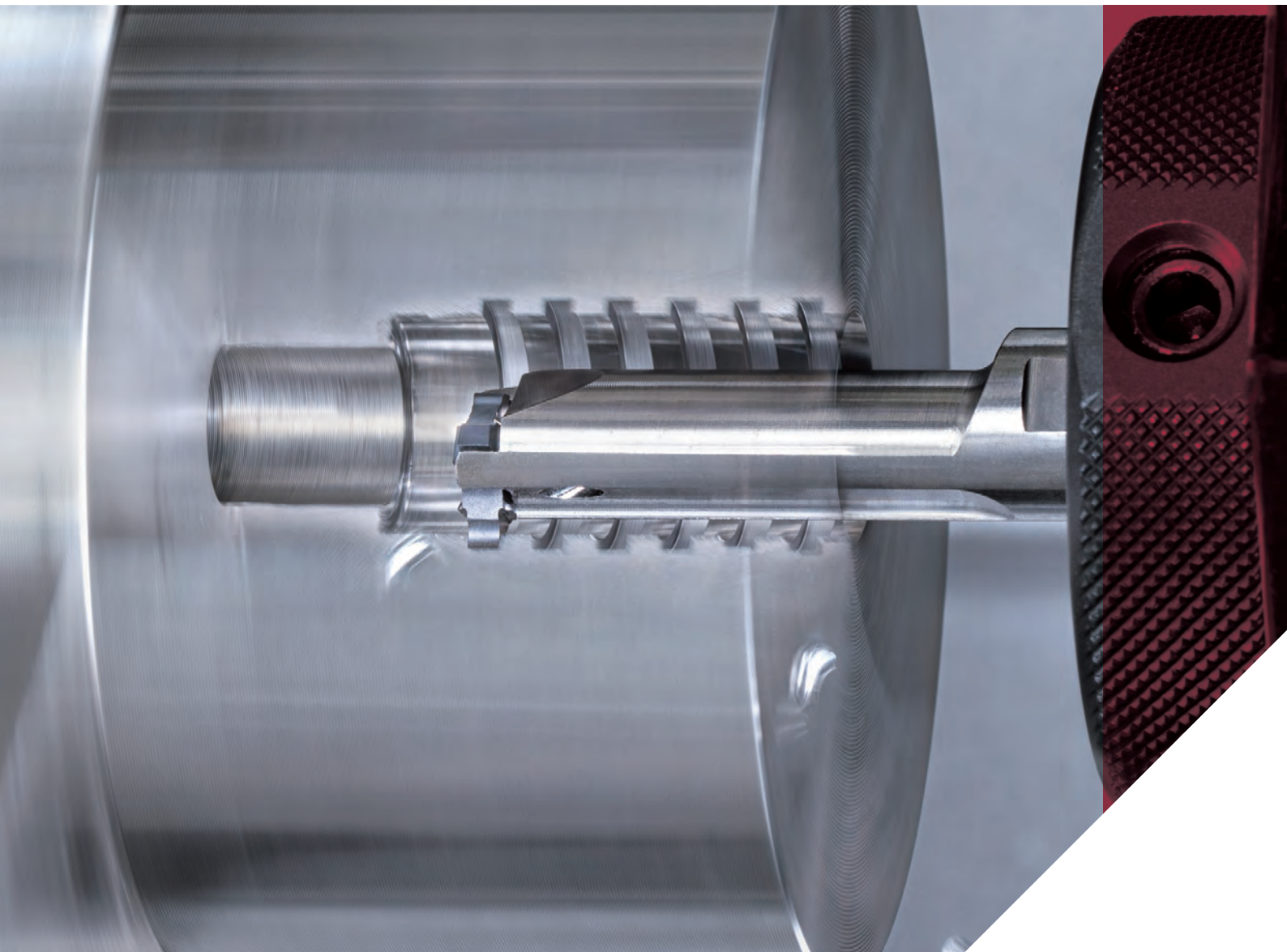



- Unique insert clamping provides secure insert edge position for good repeatability and accuracy, ensuring high quality internal grooves.
- The innovative clamping system eliminates insert movement caused by cutting forces.
- Through-coolant holder delivers coolant from the outlet located near the insert, promoting effective chip evacuation from the cutting area.
- Neutral designed insert can be mounted on either right- or left-handed holder.

Lineup

Insert

- **TCIG10...**

CW = 1.5, 2 and 2.5 mm

Max. insert cutting depth: CDX = 2 mm

Min grooving dia: DMIN = ø10.5 mm

Toolholders

- **A12H-STCIR/L...**
- **E12K-STCIR/L...**

Grade

- **AH725:** General purpose grade with superior chipping resistance. Suitable in all material groups

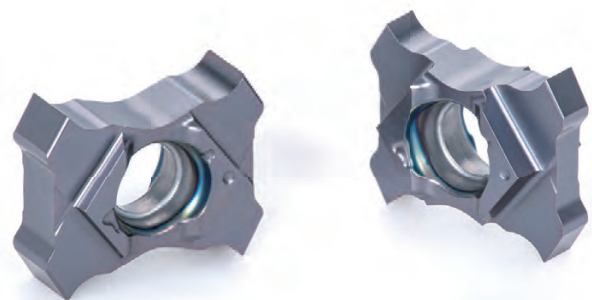

Scan this QR code to find out more about this tool!



TOOLHOLDERS

A/E-STCIR/L

Internal grooving toolholder

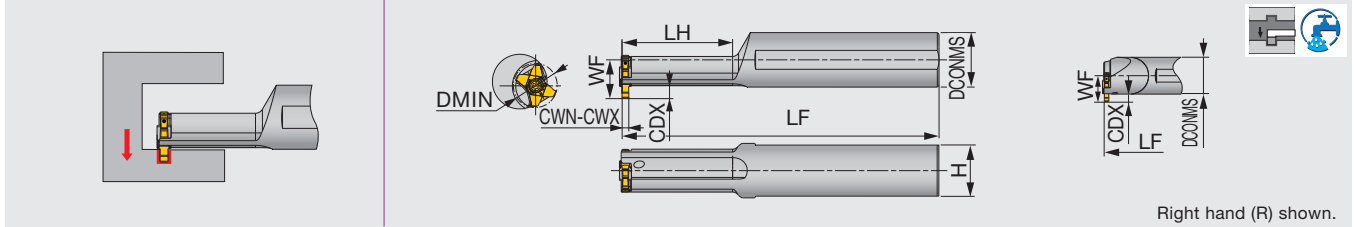

Right hand (R) shown.

Designation	Material	CWN	CWX	Seat size	DMIN	DCONMS	LH	LF	WF	H	Insert	Torque*
A12H-STCIR/L10-D105	Steel	1.5	2.5	10	10.5	12	24	100	8.3	11	TCIG10...	1
A12H-STCIR/L10-D120	Steel	1.5	2.5	10	12	12	30	100	8.3	11	TCIG10...	1
E12K-STCIR/L10-D150	Carbide	1.5	2.5	10	15	12	-	125	8.3	11	TCIG10...	1

*Torque: Recommended clamping torque (N·m)

INSERTS

TCIG

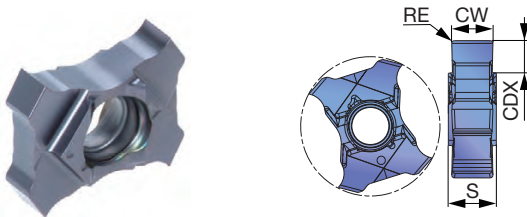

P	Steel	★									
M	Stainless	★									
K	Cast iron	★									
N	Non-ferrous										
S	Superalloys	★									
H	Hard materials										

Designation	CW±0.025	RE	Coated							CDX	S
			AH725								
TCIG10-150-010	1.5	0.1	●							2	3.5
TCIG10-200-010	2	0.1	●							2	3.5
TCIG10-250-020	2.5	0.2	●							2	3.5

Note: Max groove depth for small holes

For hole diameters less than 11.5 mm, the maximum groove depth (T max) for the insert becomes smaller than the specified value. Check the actual value in the chart below for hole diameters < 11.5 mm.

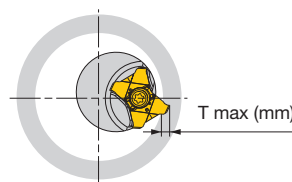
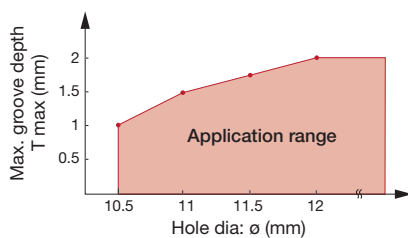

● : New

STANDARD CUTTING CONDITIONS

ISO	Workpiece material	Hardness	Priority	Cutting speed Vc (m/min)	Feed f (mm/rev)
P	Steels S45C, C45, SCM435, 34CrMo4, etc.	< 300 HB	First choice	50 - 180	0.02 - 0.08
M	Stainless steel SUS303, X10CrNiS18-9, etc.	< 200 HB	First choice	50 - 120	0.02 - 0.08
S	Titanium alloys Ti-6Al-4V, etc.	< HRC 40	First choice	20 - 80	0.02 - 0.08

TUNG^{FEED}BLADE

External grooving, Parting-off

EXTREMELY RIGID POCKET DESIGN FOR THE MOST DEMANDING CUTTING CONDITIONS

ADD speed and feed to your grooving and parting-off operations



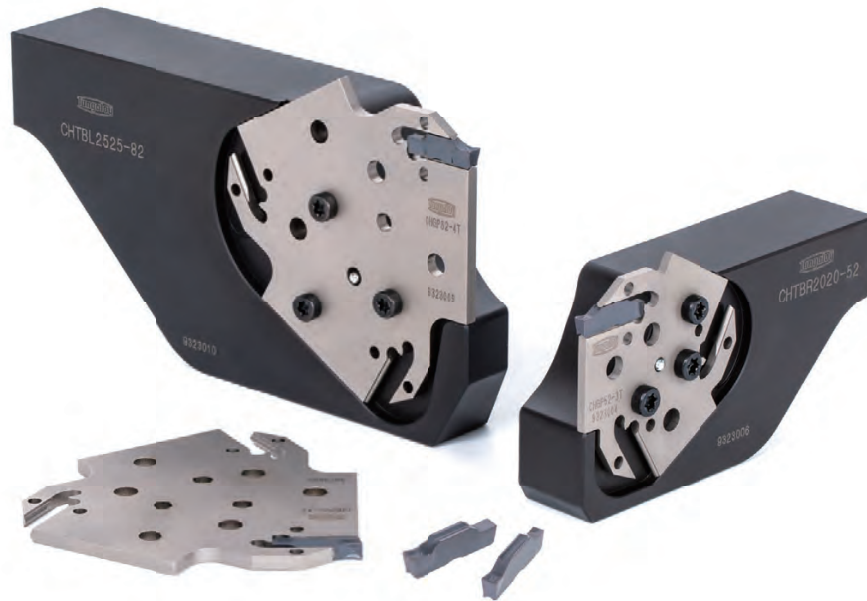

- Strong holder design ensures tool stability and productivity gain during demanding cutting conditions.
- Specially designed tool block has two contact faces to provide enhanced tool rigidity.
- The blade provides reduced tooling cost with three insert pockets, while its strong backing beneath the insert withstands heavy cutting loads during machining.
- The blades for **TungCut** series and the blades for the latest **ADDForceCut** can share the same tool block.
- The blade for **TungCut** inserts also ensures strong insert clamping, providing high tool reliability.
- The latest **ADDForceCut** blades that use a single-ended insert improves grooving /parting-off operations at increased feed rates.

Lineup

Inserts

- DGM..., DGS..., SGM..., SGS..., and DGL...

Blade

- CHGP...

CW = 2 - 4 mm

Max cut-off diameters: CUTDIA = \varnothing 52 and 82 mm

Blocks

- CHTBR/L... in sizes 2020 and 2525

Scan this QR code
to find out more
about this tool!



BLADE

CHGP

Parting-off and external grooving blade

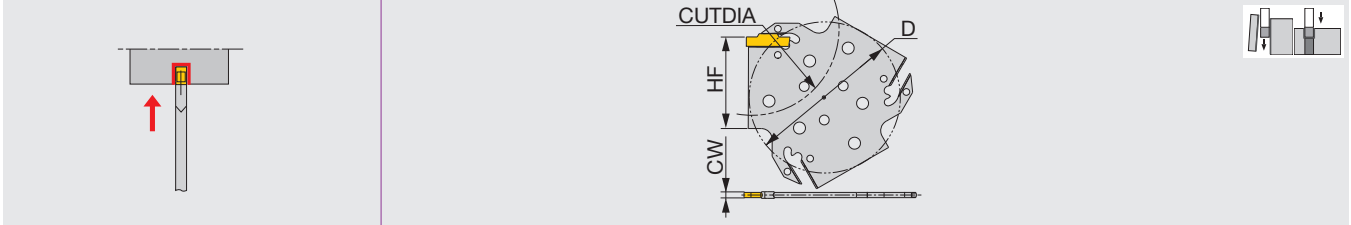

Designation	CW	Seat size	CUTDIA	HF	D
CHGP52-2T	2	2	52	27	48.3
CHGP52-3T	3	3	52	27	48.3
CHGP82-3T	3	3	82	42	69.3
CHGP82-4T	4	4	82	42	69.3

When depth is deeper than insert length - 1.5 mm, 1 corner type is recommended.

TOOL BLOCK

CHTBR/L

Tool block for CHGP blade

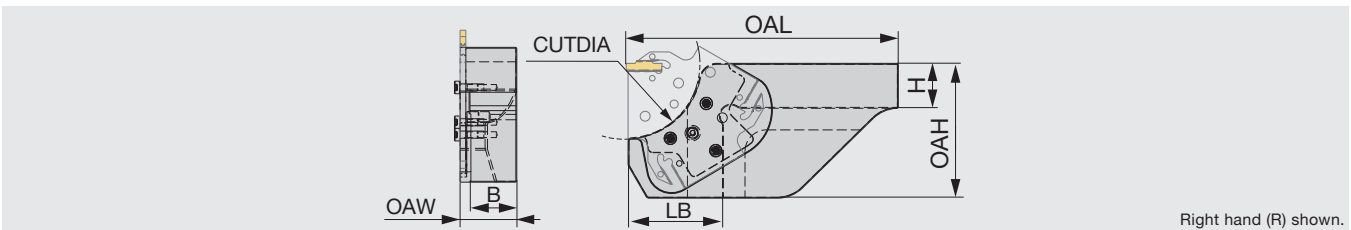

Right hand (R) shown.

Designation	CUTDIA	H	B	OAL	OAH	OAW	LB
CHTBR/L2020-52	52	20	20.5	100	50	26.5	37
CHTBR/L2525-52	52	25	25.5	125	50	31.5	37
CHTBR/L2020-82	82	20	20.5	140	75	26.5	53
CHTBR/L2525-82	82	25	25.5	150	75	31.5	53

Note: The blade clamping screw heads protrude out for as much as 3.1 mm over the insert cutting edge point.
Maintain the clearance from the chucking device to avoid interference.

Maximum groove depth : T max as function of workpiece diameter : ϕD_1

Designation	ϕD_1																	
CHTBR/L****-D52	53	54	55	56	58	60	62	65	68	72	78	84	92	102	115	133	159	198
CHTBR/L****-D82	104	108	112	116	121	127	134	142	151	162	176	192	212	237	270	313	375	468
T max	21	20	19	18	17	16	15	14	13	12	11	10	9	8	7	6	5	4

Designation	ϕD_1											
CHTBR/L****-D82	83	84	85	86	87	89	90	92	94	96	98	101
T max	34	33	31	30	29	28	27	26	25	24	23	22

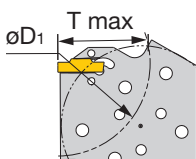

STANDARD CUTTING CONDITIONS

ISO	Workpiece material	Hardness	Grade	Cutting speed Vc (m/min)
P	Steels C45, 34CrMo4, etc.	< 300 HB	AH7025	50 - 180
M	Stainless steel X10CrNiS18-9, etc.	< 200 HB	AH7025	50 - 120
K	Gray cast iron GG25, 250, etc.	-	AH7025	50 - 180
	Ductile cast irons GGG45, 450-10S, etc.	-	AH7025	50 - 120
S	Superalloys Inconel718, etc.	< HRC 40	AH7025	20 - 60
	Titanium alloys Ti-6Al-4V, etc.	< HRC 40	AH7025	20 - 80

Scan this QR code to find out insert information.



TETRA^{FORCE}FCUT

External grooving, Parting-off

TCL38 INSERT FOR UP TO 10 MM GROOVE DEPTH

ADD deeper and accurate grooves to your machining operations

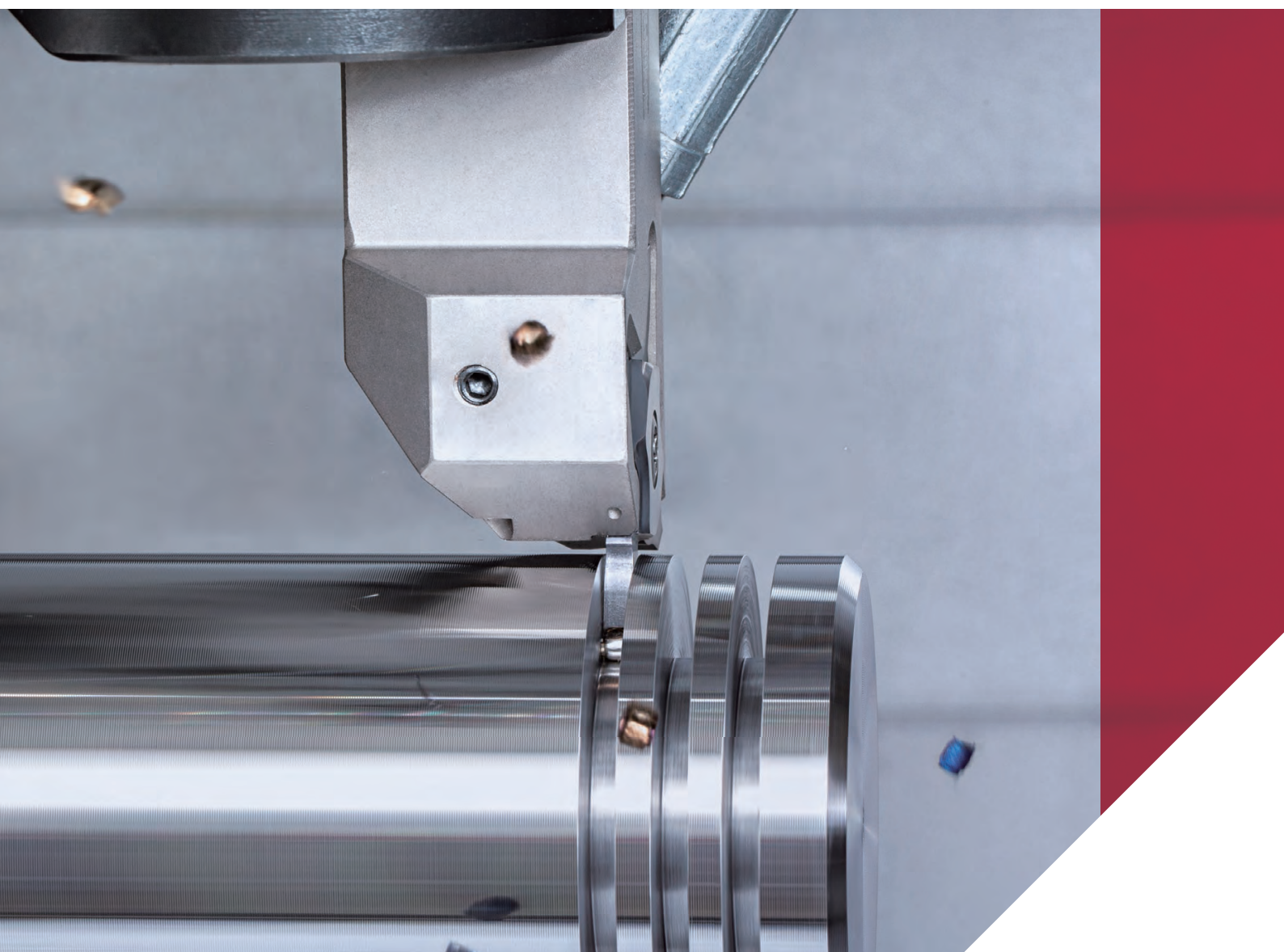



- Unique insert seat design ensures secure insert clamping, providing excellent indexing accuracy and repeatability.
- Neutral design insert can be mounted on either right- or left-handed holder.
- Insert clamping screw can be operated from either side of the holder, significantly reducing tool change time.
- Newest **TCL38** insert is capable of up to 10 mm groove depth, making it an effective tool for cutting off thick-walled tubes, as well as precision grooving operations.
- Through-coolant toolholders are also available for improved chip evacuations, promoting long tool life and superior part quality.

Lineup

Insert

- **TCL38...**

CW = 1.5 - 4 mm

Max. insert cutting depth: CDX = 10 mm

Max. parting diameters: CUTDIA = \varnothing 20 mm

Toolholders

Mono block shanks:

- **STCR/L**38** in sizes 2020, 2525 and 3232
- **STCR/L**38-CHP** (for precision internal coolant supply) in size 2525

Grade

- **AH7025**: Dedicated grade for grooving applications featuring a good balance of wear and chipping resistance

Scan this QR code
to find out more
about this tool!



INSERTS

TCL38

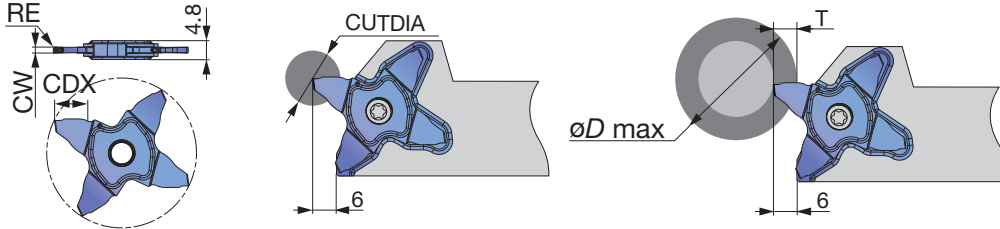

P	Steel	★		
M	Stainless	★		
K	Cast iron	★		
N	Non-ferrous			
S	Superalloys	★		
H	Hard materials			

★ : First choice

Designation	CW±0.02	RE	Coated		CDX	CUTDIA	Relation of groove depth (T) and Max. diameter (øD max)					
			AH7025				T ≤ 5	T ≤ 6	T ≤ 7	T ≤ 8	T ≤ 9	T ≤ 10
TCL38-150-020	1.5	0.2	●		9	18	∞	950	315	190	45	-
TCL38-200-020	2	0.2	●		9	18	∞	950	315	190	45	-
TCL38-300-020	3	0.2	●		10	20	∞	950	315	190	130	50
TCL38-400-030	4	0.3	●		10	20	∞	950	315	190	130	50

● : New

TOOLHOLDERS

STCR/L-38 (-CHP)

External grooving and parting toolholder

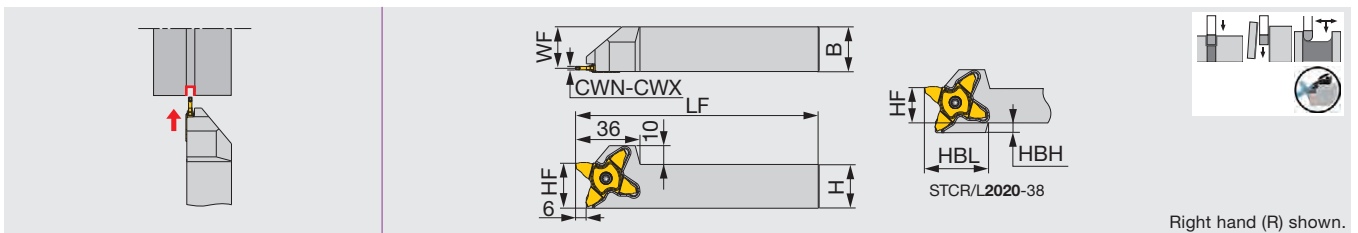

Right hand (R) shown.

Designation	CWN	CWX	H	B	LF	HF	WF	HBH	HBL	Insert	Torque*
STCR/L2020-38	1.5	4	20	20	120	20	18.1	5	35	TCL38...	2.5
STCR/L2525-38	1.5	4	25	25	135	25	23.1	-	-	TCL38...	2.5
STCR/L3232-38	1.5	4	32	32	135	32	30.1	-	-	TCL38...	2.5
STCR/L2525-38-CHP	1.5	4	25	25	135	25	23.1	-	-	TCL38...	2.5

*Torque: Recommended clamping torque (N·m)

STANDARD CUTTING CONDITIONS

ISO	Workpiece materials	Grades	Cutting speed Vc (m/min)	Feed f (mm/rev)
P	Carbon steel S45C, C45, etc.	AH7025	80 - 180	0.03 - 0.18
	Alloy steel SCM435, 34CrMo4, etc.	AH7025	50 - 180	0.03 - 0.18
M	Alloy steel SCM435, 34CrMo4, etc.	AH7025	50 - 150	0.03 - 0.14
K	Grey cast iron FC250, 250, GG25, etc.	AH7025	50 - 180	0.03 - 0.14
	Ductile cast iron FCD400, 400-15, GGG400, etc.	AH7025	50 - 120	0.03 - 0.14
S	Titanium alloys Ti-6Al-4V, etc.	AH7025	30 - 60	0.03 - 0.14
	Superalloys Inconel718, etc.	AH7025	20 - 50	0.03 - 0.14

DUO^{UST}JCUT

External grooving, Parting-off

PARTING-OFF TOOL WITH OPTIMIZED INSERT CLAMPING

ADD secure parting-off and threading operations of $< \varnothing 20$ mm bar stocks

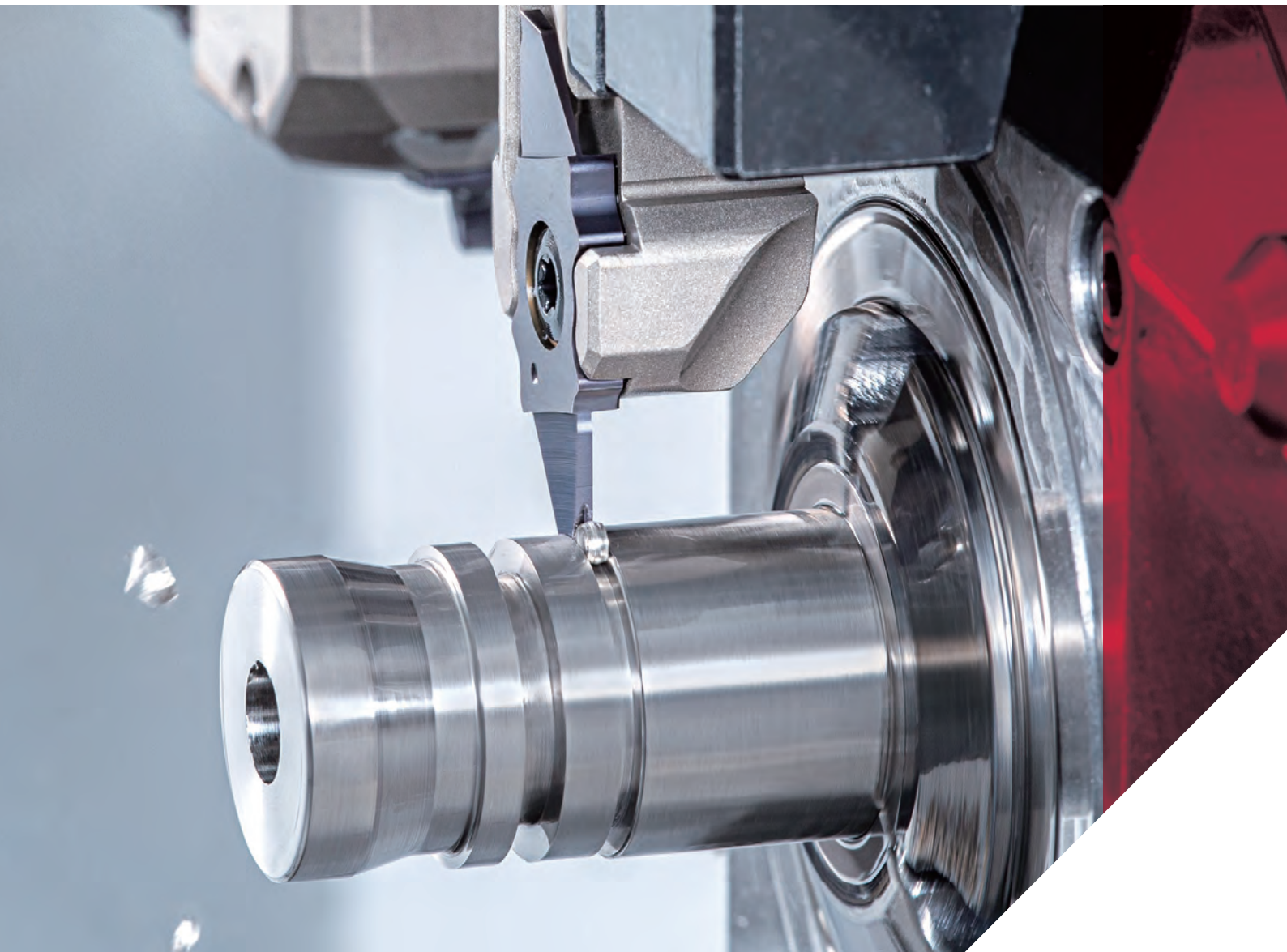

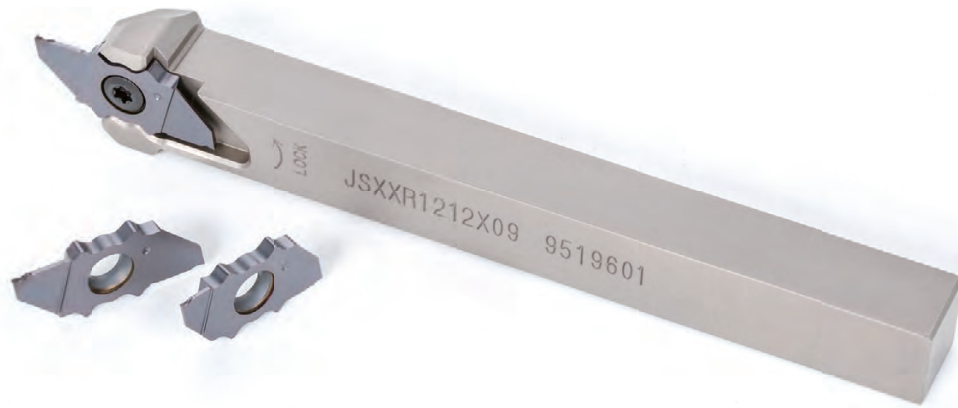

- Innovative insert clamping design ensures process security in all parting operations and protects unused cutting edge from damage.
- Four different sizes of inserts fit the same cutter body, enabling the selection of optimum insert overhang for the workpiece diameter.
- Pressed-to-form 3D chipbreaker provides flexible and effective chip control. This eliminates chip re-cutting, preventing edge chipping and poor surface quality.
- 0.6 mm and 0.8 mm width inserts now have a pressed-to-form chipbreaker, saving material waste for improved tool economy for mass production.
- Offers toolholders ideal for the use on Swiss machines. In combination with TungTurn-Jet through-coolant toolholders, the inserts provide productivity gains.
- New **JXDX** type PCD-tipped grooving inserts with 3D laser-etched chipbreaker for machining of complicated aluminum parts are now available.

Lineup

Inserts

- **JXPS06R/L06F**

CW = 0.6 mm

Max. parting diameters: CUTDIA = \varnothing 6 mm

- **JXPS12R/L08F**

CW = 0.8 mm

Max. parting diameters: CUTDIA = \varnothing 12 mm

- **JXDX12R..., 16R...**

CW = 2, 2.5 mm

CDX = 7 mm

Grades

- **SH725** : Well balanced combination of the latest coating layer and tough carbide substrate provides long tool life
- **DX110** : Excellent cutting edge integrity that maintains sharpness over long period of time

Toolholders

- **JSXXR/L...**

- **JSXXR/L**-S**

- **JSXXR/L**-CHP**

(for precision internal coolant supply)

- **JSXXR/L**-S-CHP**

(for precision internal coolant supply)

Scan this QR code
to find out more
about this tool!



TOOLHOLDERS

JSXXR/L

Parting-off and grooving tools

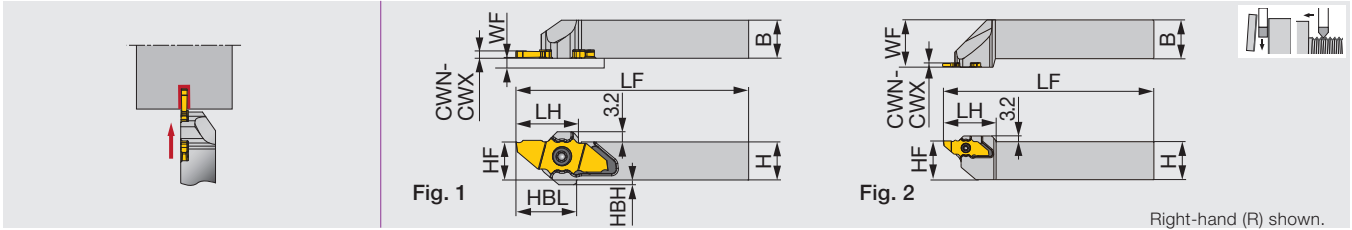

Designation	CWN	CWX	H	B	LF**	LH**	HF	WF	HBL**	HBH	Insert	Torque*	Fig.
JSXXR/L1010X09	1	2	10	10	120	19.65	10	0.2	19	3	JX**06...,12...,16..., 20...	1.2	1
JSXXR/L1212F09	1	2	12	12	85	19.65	12	0.2	19	1.5	JX**06...,12...,16..., 20...	1.2	1
JSXXR/L1212X09	1	2	12	12	120	19.65	12	0.2	19	1.5	JX**06...,12...,16..., 20...	1.2	1
JSXXR/L1616X09	1	2	16	16	120	19.65	16	0.2	-	-	JX**06...,12...,16..., 20...	1.2	1
JSXXR/L2020H09	1	2	20	20	100	22.5	20	0.2	-	-	JX**06...,12...,16..., 20...	1.2	1
JSXXR/L2525Z09	1	2	25	25	135	34	25	30	-	-	JX**06...,12...,16..., 20...	1.2	2

*Torque: Recommended torque (N-m) for clamping

LF (Functional Length) LH (Head Length), and HBL (Head-bottom Offset Length) values shown above are true with JX16... insert. LF, LH, and HBL will all be 2 mm shorter than the above values with JX**12... and JX**20... inserts, and 4 mm shorter for JX**06... insert.

Note: Use the right-hand insert (JX****R...) for a right-hand holder (JSXXR...); the left-hand insert (JX****L...) for a left-hand holder (JSXXL...).

JSXXR/L-X-CHP



Parting-off tool for swiss lathes, coolant-through

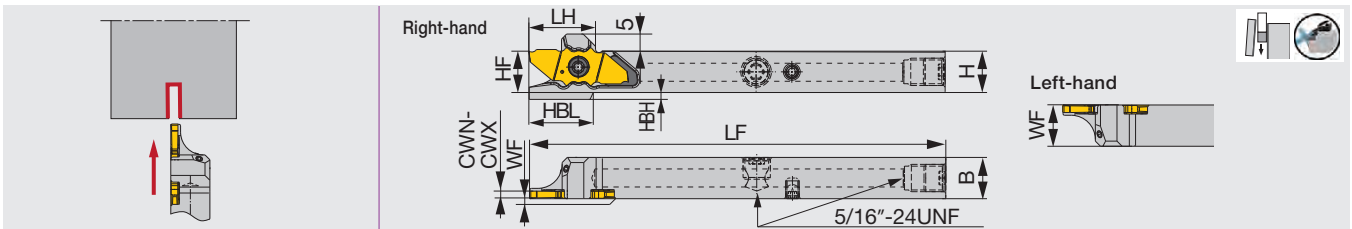

Designation	CWN	CWX	H	B	LF**	LH**	HF	WF	HBL**	HBH	Insert	Torque*
JSXXR/L1012H09-CHP	1	2	10	12	102	19.2	10	0.2/11.8	18.7	3	JX**06...,12...,16..., 20...	1.2
JSXXR/L1212X09-CHP	1	2	12	12	120	19.4	12	0.2/11.8	18.8	2	JX**06...,12...,16..., 20...	1.2
JSXXR/L1616X09-CHP***	1	2	16	16	120	19.4	16	0.2/15.8	18.7	2.5	JX**06...,12...,16..., 20...	1.2
JSXXR/L1616X09B-CHP	1	2	16	16	120	19.4	16	0.2/15.8	18.7	-	JX**06...,12...,16..., 20...	1.2

*Torque: Recommended torque (N-m) for clamping

LF (Functional Length) LH (Head Length), and HBL (Head-bottom Offset Length) values shown above are true with JX16... insert. LF, LH, and HBL will all be 2 mm shorter than the above values with JX**12... and JX**20... inserts, and 4 mm shorter for JX**06... insert.

***To be replaced with the new design

Note: Use the right-hand insert (JX****R...) for a right-hand holder (JSXXR...); the left-hand insert (JX****L...) for a left-hand holder (JSXXL...).

JSXXR/L-F-CHP



Parting-off tool for swiss lathes

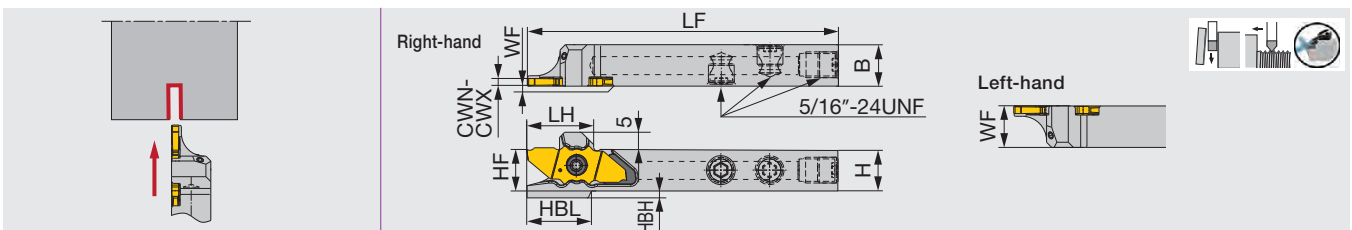

Designation	CWN	CWX	H	B	LF**	LH**	HF	WF	HBL**	HBH	Insert	Torque*
JSXXR/L1212F09-CHP	1	2	12	12	85	19.4	12	0.2/11.8	18.8	2	JX**06...,12...,16..., 20...	1.2

*Torque: Recommended torque (N-m) for clamping

LF (Functional Length) LH (Head Length), and HBL (Head-bottom Offset Length) values shown above are true with JX16... insert. LF, LH, and HBL will all be 2 mm shorter than the above values with JX**12... and JX**20... inserts, and 4 mm shorter for JX**06... insert.

Note: Use the right-hand insert (JX****R...) for a right-hand holder (JSXXR...); the left-hand insert (JX****L...) for a left-hand holder (JSXXL...).

JSXXR/L-S

Parting-off tool for sub spindle in swiss lathes

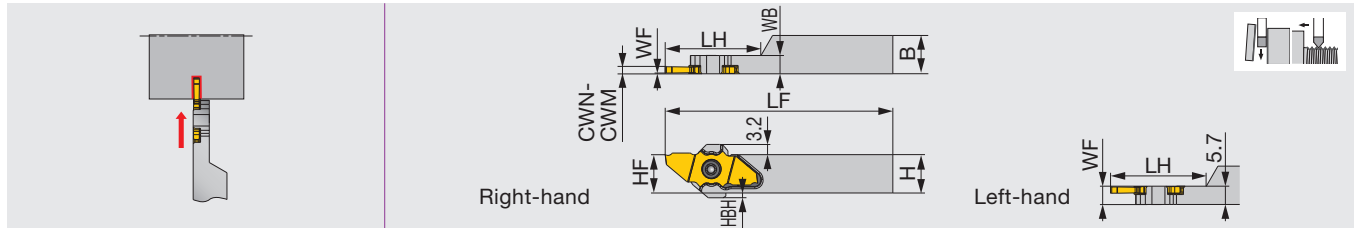

Designation	CWN	CWM	H	B	LF**	LH**	HF	WF	HBH	Insert	Torque*
JSXXR/L1010X09-S***	1	2	10	10	120	26	10	0.2/5.5	3	JX**06...,12...,16...***	1.2
JSXXR/L1212F09-S***	1	2	12	12	85	26	12	0.2/5.5	1.5	JX**06...,12...,16...***	1.2
JSXXR/L1212X09-S***	1	2	12	12	120	30	12	0.2/5.5	1.5	JX**06...,12...,16...***	1.2
JSXXR/L1616X09-S	1	2	16	16	120	30	16	0.2/5.5	-	JX**06...,12...,16..., 20...	1.2

*Torque: Recommended torque (N-m) for clamping

LF (Functional Length) and LH (Head Length) values shown above are true with JX16... insert. Both LF and LH will be 2 mm shorter than the above value with JX**12... and JX**20... inserts; 4 mm shorter with JX**06... insert.

***JX**20... insert will not fit.

Note: Use the right-hand insert (JX****R...) for a right-hand holder (JSXXR...); the left-hand insert (JX****L...) for a left-hand holder (JSXXL...).

JSXXR/L-X-S-CHP



Parting-off tool for sub spindle in swiss lathes, coolant-through

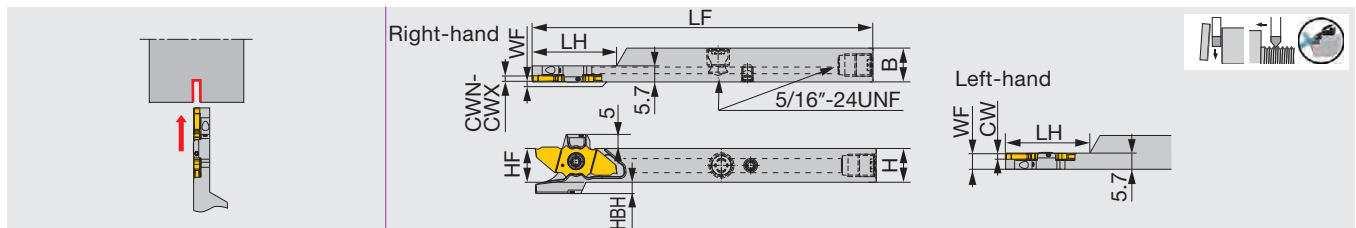

Designation	CWN	CWX	H	B	LF**	LH**	HF	WF	HBH	Insert	Torque*
JSXXR/L1212X09-S-CHP***	1	2	12	12	120	30	12	0.2/5.5	4	JX**06...,12...,16..., 20...	1.2
JSXXR/L1212X09B-S-CHP	1	2	12	12	120	30	12	0.2/5.5	2	JX**06...,12...,16..., 20...	1.2
JSXXR/L1616X09-S-CHP***	1	2	16	16	120	30	16	0.2/5.5	1.5	JX**06...,12...,16..., 20...	1.2
JSXXR/L1616X09B-S-CHP	1	2	16	16	120	30	16	0.2/5.5	-	JX**06...,12...,16..., 20...	1.2

*Torque: Recommended torque (N-m) for clamping

LF (Functional Length) and LH (Head Length) values shown above are true with JX16... insert. Both LF and LH will be 2 mm shorter than the above value with JX**12... and JX**20... inserts; 4 mm shorter with JX**06... insert.

***To be replaced with the new design

Note: Use the right-hand insert (JX****R...) for a right-hand holder (JSXXR...); the left-hand insert (JX****L...) for a left-hand holder (JSXXL...).

JSXXR/L-F-S-CHP



Parting-off tool for sub spindle in swiss lathes

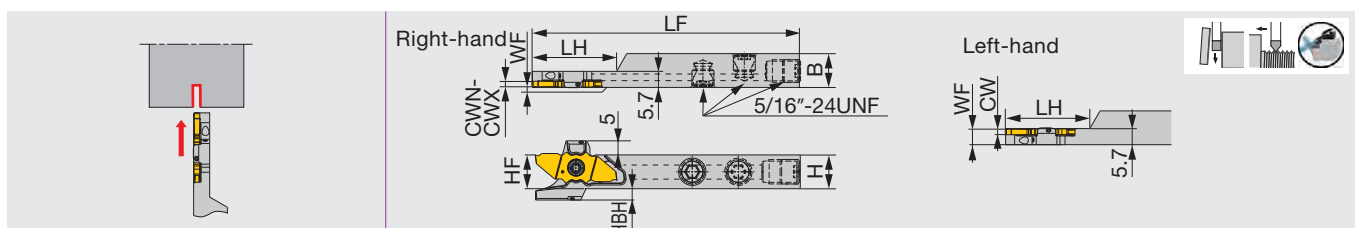

Designation	CWN	CWX	H	B	LF**	LH**	HF	WF	HBH	Insert	Torque*
JSXXR/L1212F09-S-CHP***	1	2	12	12	85	26	12	0.2/5.5	4	JX**06...,12...,16..., 20...	1.2
JSXXR/L1212F09B-S-CHP	1	2	12	12	85	30	12	0.2/5.5	2	JX**06...,12...,16..., 20...	1.2

*Torque: Recommended torque (N-m) for clamping

LF (Functional Length) and LH (Head Length) values shown above are true with JX16... insert. Both LF and LH will be 2 mm shorter than the above value with JX**12... and JX**20... inserts; 4 mm shorter with JX**06... insert.

***To be replaced with the new design

Note: Use the right-hand insert (JX****R...) for a right-hand holder (JSXXR...); the left-hand insert (JX****L...) for a left-hand holder (JSXXL...).

INSERTS

JXPS**R/L-F (with 3D chipbreaker, sharp edge)

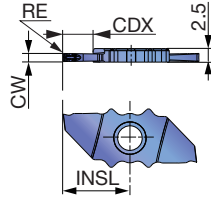

Right-hand (R) shown.

P	Steel	★						
M	Stainless	★						
K	Cast iron	★						
N	Non-ferrous							
S	Superalloys	★						
H	Hard materials							

★ : First choice

Designation	HAND	CW±0.025	RE	Coated				CUTDIA	CDX*	INSL
				SH725						
JXPS06R06F	R	0.6	0.05	●				6	3.5	10.5
JXPS06L06F	L	0.6	0.05	●				6	3.5	10.5
JXPS12R08F	R	0.8	0.05	●				12	6.5	12.5
JXPS12L08F	L	0.8	0.05	●				12	6.5	12.5
JXPS12R10F	R	1	0.05	●				12	6.5	12.5
JXPS12L10F	L	1	0.05	●				12	6.5	12.5
JXPS12R15F	R	1.5	0.05	●				12	6.5	12.5
JXPS12L15F	L	1.5	0.05	●				12	6.5	12.5
JXPS16R15F	R	1.5	0.05	●				16	8.5	14.5
JXPS16L15F	L	1.5	0.05	●				16	8.5	14.5
JXPS20R20F	R	2	0.05	●				20	10.5	16.5
JXPS20L20F	L	2	0.05	●				20	10.5	16.5

*Max grooving depth (CDX) varies depending on workpiece diameters.

● : Will be released in December 2021

● : Line-up

JXDX**R-F (PCD insert)

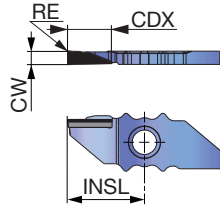

P	Steel							
M	Stainless							
K	Cast iron							
N	Non-ferrous	★						
S	Superalloys							
H	Hard materials							

★ : First choice

Designation	HAND	CW±0.025	RE	PCD				CDX	INSL
				DX110					
JXDX12R20F	R	2	< 0.1	●				6	12.5
JXDX12R25F	R	2.5	< 0.1	●				6.5	12.5
JXDX16R25F	R	2.5	< 0.1	●				7	14.5

● : New

JXPGR/L-F (Sharp edge)**

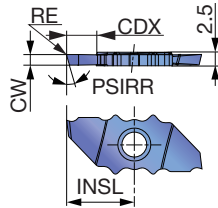
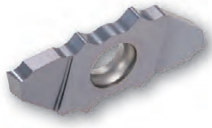

Right-hand (R) shown.

P	Steel	★					
M	Stainless	★					
K	Cast iron	★					
N	Non-ferrous						
S	Superalloys	★					
H	Hard materials						

★ : First choice

Designation	HAND	CW±0.025	RE	Coated				CUTDIA	CDX*	INSL	PSIRR/L**
				SH725							
JXPG06R10F	R	1	0.05	●				6	3.5	10.5	0°
JXPG06L10F	L	1	0.05	●				6	3.5	10.5	0°
JXPG06R15F	R	1.5	0.05	●				6	3.5	10.5	0°
JXPG06L15F	L	1.5	0.05	●				6	3.5	10.5	0°
JXPG06R10F-15	R	1	0.05	●				6	3.5	10.5	15°
JXPG06L10F-15	L	1	0.05	●				6	3.5	10.5	15°
JXPG06R15F-15	R	1.5	0.05	●				6	3.5	10.5	15°
JXPG06L15F-15	L	1.5	0.05	●				6	3.5	10.5	15°
JXPG12R15F	R	1.5	0.05	●				12	6.5	12.5	0°
JXPG12L15F	L	1.5	0.05	●				12	6.5	12.5	0°
JXPG12R20F	R	2	0.05	●				12	6.5	12.5	0°
JXPG12L20F	L	2	0.05	●				12	6.5	12.5	0°
JXPG12R15F-15	R	1.5	0.05	●				12	6.5	12.5	15°
JXPG12L15F-15	L	1.5	0.05	●				12	6.5	12.5	15°
JXPG12R20F-15	R	2	0.05	●				12	6.5	12.5	15°
JXPG12L20F-15	L	2	0.05	●				12	6.5	12.5	15°
JXPG16R15F	R	1.5	0.05	●				16	8.5	14.5	0°
JXPG16L15F	L	1.5	0.05	●				16	8.5	14.5	0°
JXPG16R20F	R	2	0.05	●				16	8.5	14.5	0°
JXPG16L20F	L	2	0.05	●				16	8.5	14.5	0°
JXPG16R15F-15	R	1.5	0.05	●				16	8.5	14.5	15°
JXPG16L15F-15	L	1.5	0.05	●				16	8.5	14.5	15°
JXPG16R20F-15	R	2	0.05	●				16	8.5	14.5	15°
JXPG16L20F-15	L	2	0.05	●				16	8.5	14.5	15°
JXPG20R15F	R	1.5	0.05	●				20	10.5	16.5	0°
JXPG20L15F	L	1.5	0.05	●				20	10.5	16.5	0°
JXPG20R20F	R	2	0.05	●				20	10.5	16.5	0°
JXPG20L20F	L	2	0.05	●				20	10.5	16.5	0°
JXPG20R15F-15	R	1.5	0.05	●				20	10.5	16.5	15°
JXPG20L15F-15	L	1.5	0.05	●				20	10.5	16.5	15°
JXPG20R20F-15	R	2	0.05	●				20	10.5	16.5	15°
JXPG20L20F-15	L	2	0.05	●				20	10.5	16.5	15°

*Max grooving depth (CDX) varies depending on workpiece diameters.

● : Line-up

**PSIRR for Left-hand insert.

TOOLHOLDERS

JS-SXXL09

Round shanks, for threading

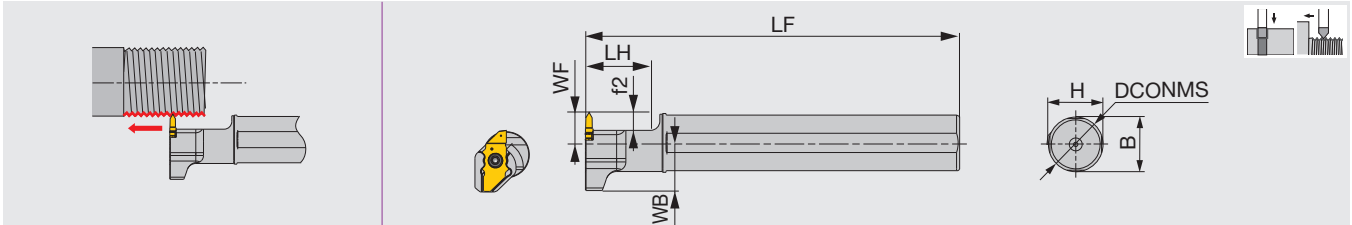

Designation	DCONMS	H	B	LF	LH	WB	WF**	f2**	Insert	Torque*
JS19G-SXXL09	19.05	18	18	90	21	15.43	10	6	JX**06,12*R	1.2
JS19X-SXXL09	19.05	18	18	120	21	15.43	10	6	JX**06,12*R	1.2
JS20G-SXXL09	20	19	19	90	21	15.4	10	6	JX**06,12*R	1.2
JS20X-SXXL09	20	19	19	120	21	15.4	10	6	JX**06,12*R	1.2
JS22X-SXXL09	22	21	21	120	21	15.4	10	6	JX**06,12*R	1.2
JS25H-SXXL09	25	24	24	100	21	15.4	10	6	JX**06,12*R	1.2
JS254X-SXXL09	25.4	24	24	120	21	15.4	10	6	JX**06,12*R	1.2

* Torque: Recommended torque (N·m) for clamping

** When using JX..06... insert, both WF and f2 sizes will be 2 mm shorter than the values provided above.

INSERTS

JXTG12FR/L-60 (For Threading / Sharp edge)

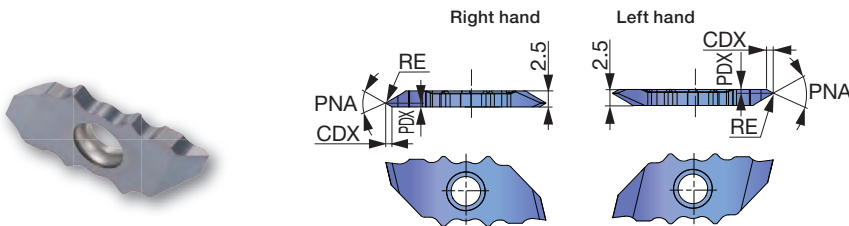

Designation	RE	SH725		Pitches	PDX	CDX	PNA
		R	L				
JXTG12FR/L-60A-000	flat (0.05 max)	●	●	0.2 - 0.4	0.25	0.4	60°
JXTG12FR/L-60B-000	flat (0.05 max)	●	●	0.2 - 0.4	2.25	0.4	60°
JXTG12FR/L-60A-005	0.05	●	●	0.4 - 1	0.6	0.99	60°
JXTG12FR/L-60B-005	0.05	●	●	0.4 - 1	1.9	0.99	60°
JXTG12FR/L-60N-010	0.1	●	●	1 - 1.5	1.25	2.07	60°

●: Line-up

EDGE ORIENTATION AND DESCRIPTION OF THREADING INSERTS

	Type A	Type B	Type N
Right hand			
Left hand			

JXTG 12 F R - 60 A - 005

Insert shape | Insert size | Hand | Thread angle | Edge orientation | Corner radius

F: sharp edge

STANDARD CUTTING CONDITIONS

Parting, Grooving

ISO	Workpiece materials	Grades	Cutting speed Vc (m/min)	Feed f (mm/rev)
P	Low carbon steels S15C, SS400, etc. C15E4, E275A, etc.	SH725	50 - 200	0.01 - 0.05
	Carbon steels, Alloy steels S55C, SCM440, etc. C55, 42CrMo4, etc.	SH725	50 - 200	0.01 - 0.05
	Free cutting steels SUH22, SUH23, etc.	SH725	50 - 200	0.01 - 0.05
M	Stainless steels SUS304, X5CrNi18-9, etc.	SH725	50 - 200	0.01 - 0.05
N	Aluminium alloys A5056, A6061, etc.	SH725	150 - 200	0.01 - 0.05
	Copper alloy C2600, C280C, etc.	SH725	100 - 200	0.01 - 0.05
S	Titanium alloys Ti-6Al-4V, etc.	SH725	30 - 80	0.01 - 0.05
	Superalloys Inconel718, etc.	SH725	30 - 80	0.01 - 0.05

For aluminium and non-ferrous metal PCD insert

ISO	Workpiece materials	Grades	Operation	Cutting speed Vc (m/min)	Feed f (mm/rev)	Depth of cut ap (mm)
N	Aluminium alloys A5056, A6061, etc.	DX110	Grooving	100 - 300	0.03 - 0.15	-
		DX110	Turning	100 - 300	0.03 - 0.15	< 6



Turning

- 42 BoreMeister
- 52 TinyMiniTurn
- 60 MiniForceTurn /
WavyJoint CBN
- 64 ModuMiniTurn

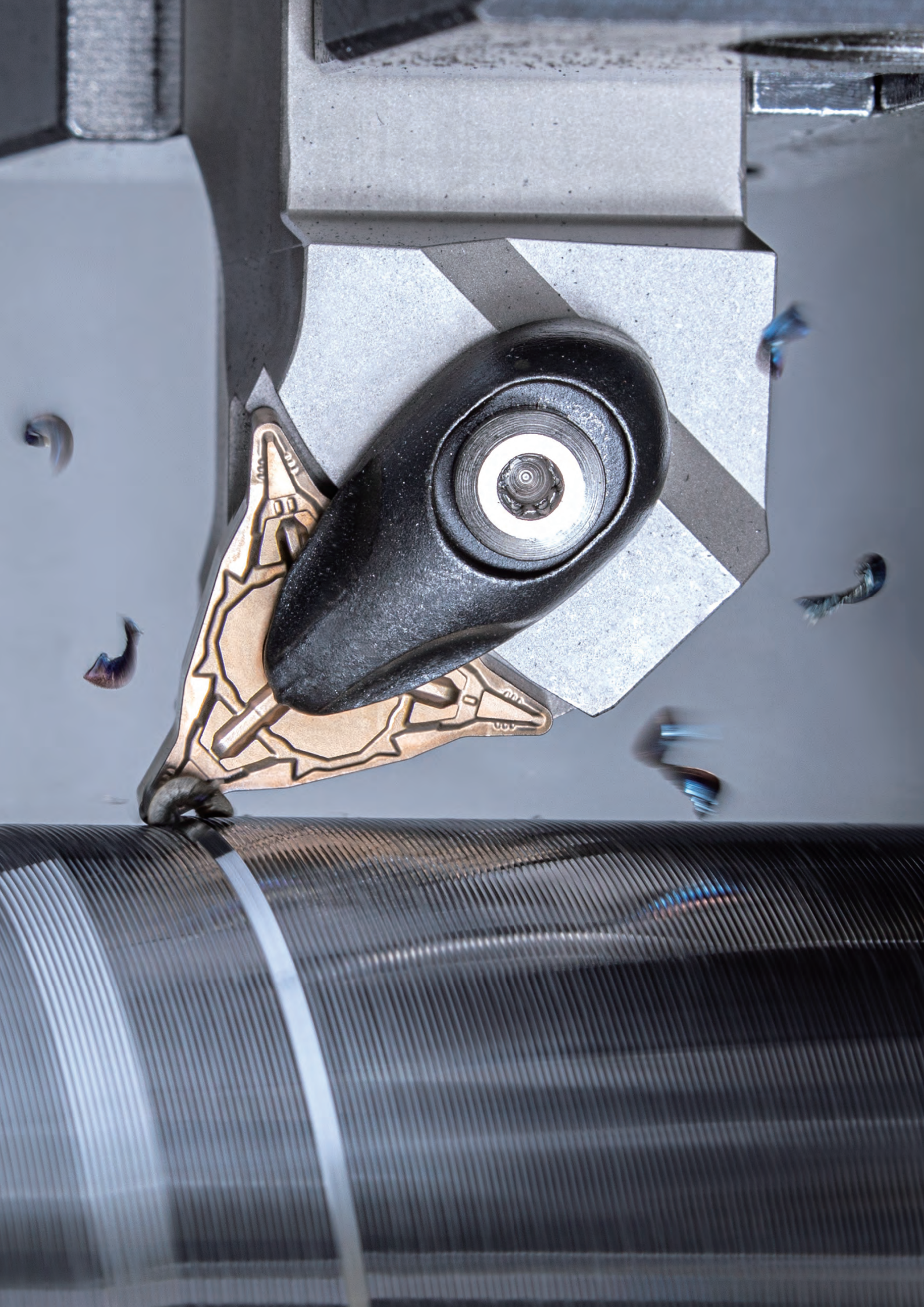

BOREMEISTER

Internal turning

VIBRATION-FREE SOLUTION FOR DEEP-HOLE BORING

ADD stability and precision

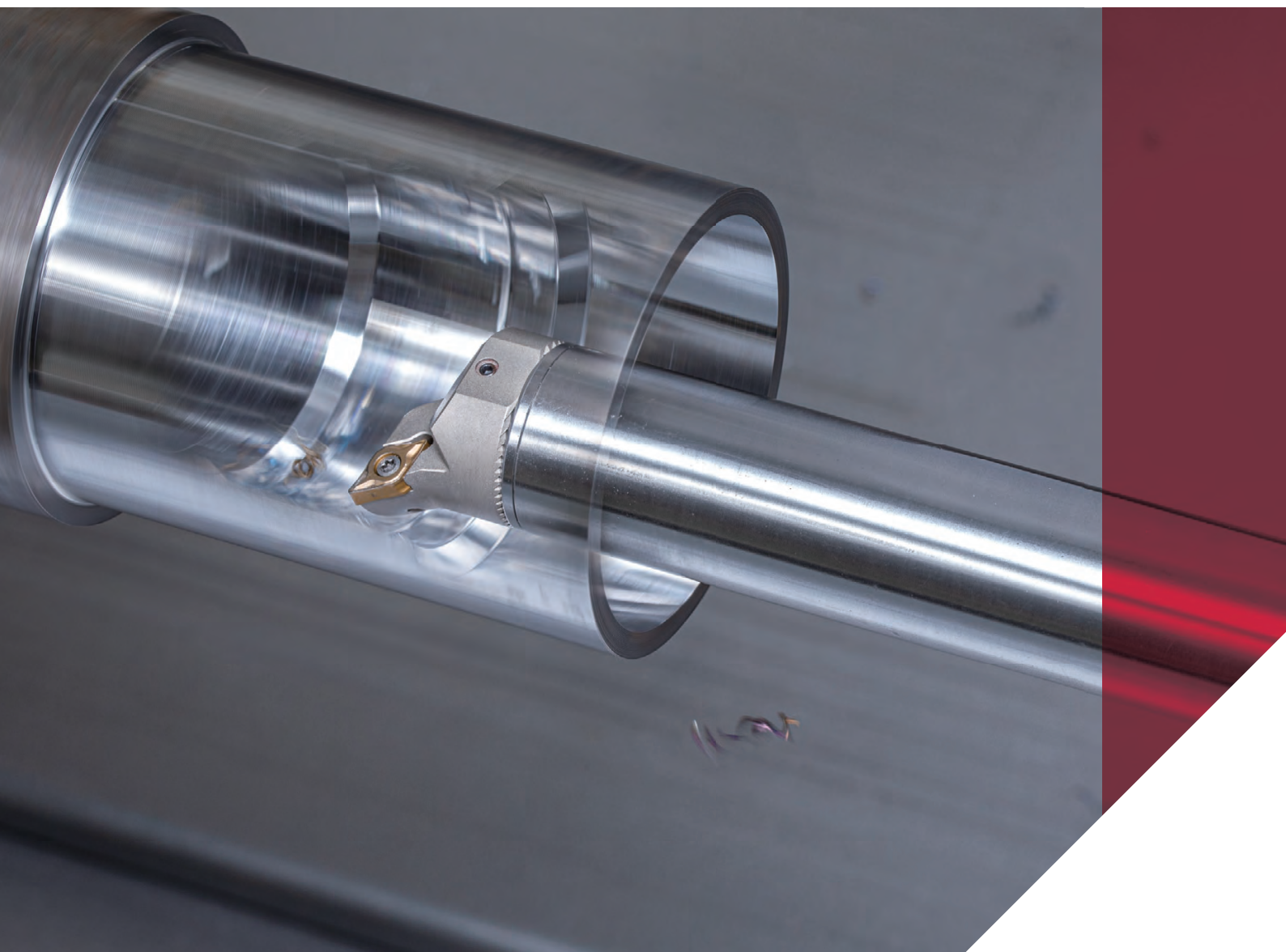



- Ultimate solution to conquer tool overhang challenges, chattering, noise and short tool life of up to 10xD.
- Exchangeable head boring tool system with serrated interfaces for high precision and high rigidity indexing.
- Through-coolant capability allows smooth chip evacuation in deep boring operations of up to 10xD.
- PSC holders are also available, allowing coupling with a range of machine tools.
- A wide range of boring heads are available, providing high parts quality in various boring operations.
- Dedicated setting device allows quick and accurate center height settings of the boring bar.

Lineup

Heads

BoreMeister heads are available for:

- **ISO-EcoTurn** economical inserts
- **MiniForce-Turn** double-sided positive inserts
- **TungBore-Mini** inserts for hole making and turning
- **TungThread** ST-style inserts for threading
- **AddForceCut**: Single corner insert for internal grooving

Shanks

- Steel shanks: 4xD, 7xD, 10xD
 DCONMS = \varnothing 16 - 60 mm
- Carbide shanks: 10xD
 DCONMS = \varnothing 16 - 20 mm
- PSC adapter: 2.5xD, 3xD, 5xD, 9xD
 PSC size = C4, C6

A wide range of boring heads are available.



Scan this QR code to find out more about this tool!



HEAD

S-SCLCR/L-H

Screw-on clamp interchangeable boring heads for positive 80° rhombic inserts

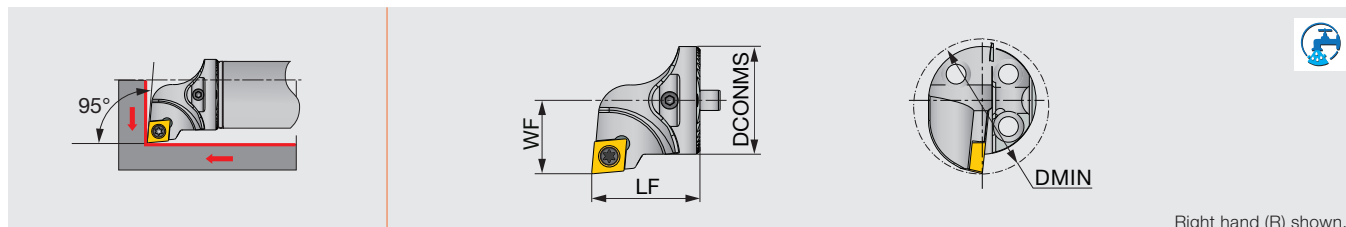

Right hand (R) shown.

Designation	DMIN	DCONMS	WF	LF	Shank size	Insert
S16-SCLCR/L06-H	20	16	11	20	D/G16	CC**0602...
S20-SCLCR/L09-H	25	20	13	20	D/G20	CC**09T3...
S25-SCLCR/L09-H	32	25	17	22	D25	CC**09T3...
S32-SCLCR/L09-H	40	30	22	32	D32	CC**09T3...
S40-SCLCR/L12T-H	50	40	27	38	D40, D50, D60	CC**1204...

Note: When using a right or left hand insert, the right hand insert (R) is used for the left hand toolholders (SCLCL** type), and the left hand insert (L) is used for the right hand toolholders (SCLCR** type).

S-SDUCR/L-H

Screw-on clamp interchangeable boring heads for positive 55° rhombic inserts

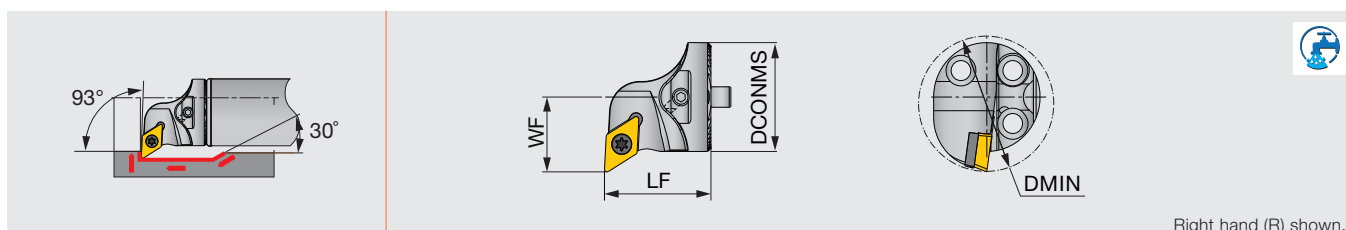

Right hand (R) shown.

Designation	DMIN	DCONMS	WF	LF	Shank size	Insert
S16-SDUCR/L07-H	20	16	11	20	D/G16	DC**0702...
S20-SDUCR/L11-H	25	20	13	20	D/G20	DC**11T3...
S25-SDUCR/L11-H	32	25	17	20	D25	DC**11T3...
S32-SDUCR/L11T-H	40	32	22	32	D32	DC**11T3...
S40-SDUCR/L11T-H	50	40	27	32	D40, D50, D60	DC**11T3...

Note: When using a right or left hand insert, the right hand insert (R) is used for the left hand toolholders (SDUCL** type), and the left hand insert (L) is used for the right hand toolholders (SDUCR** type).

S-SVUCR/L-H

Screw-on clamp interchangeable boring heads for positive 35° rhombic inserts

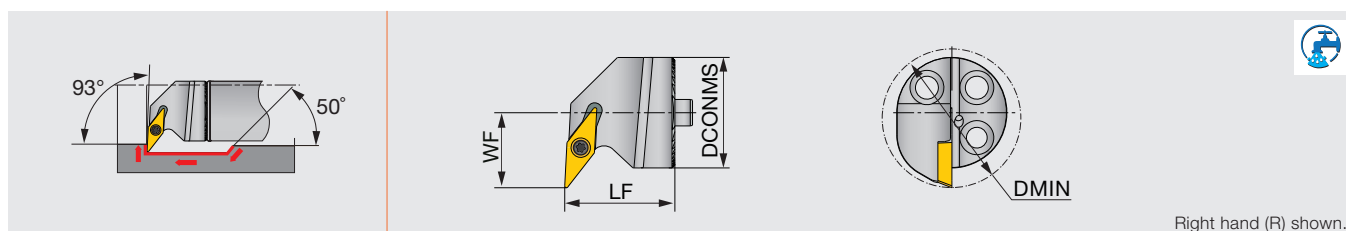

Right hand (R) shown.

Designation	DMIN	DCONMS	WF	LF	Shank size	Insert
S20-SVUCR/L11-H	27	20	16	20	D/G20	VC**1103...
S25-SVUCR/L11-H	31	25	17	25	D25	VC**1103...

Note: When using a right or left hand insert, the right hand insert (R) is used for the left hand toolholders (SVUCL** type), and the left hand insert (L) is used for the right hand toolholders (SVUCR** type).

S-SVLCR/L-H

Screw-on clamp interchangeable boring heads for positive 35° rhombic inserts

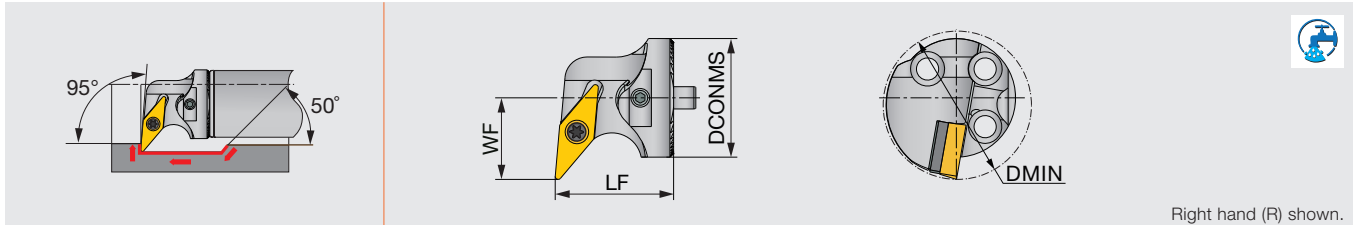

Right hand (R) shown.

Designation	DMIN	DCONMS	WF	LF	Shank size	Insert
S32-SVLCR/L16T-H	40	32	22	32	D32	VC**1604...
S40-SVLCR/L16T-H	50	40	27	32	D40, D50, D60	VC**1604...

Note: When using a right or left hand insert, the right hand insert (R) is used for the left hand toolholders (SVLCL** type), and the left hand insert (L) is used for the right hand toolholders (SVLCR** type).

S-DDUNR/L-H

Double clamp interchangeable boring heads for negative 55° rhombic inserts

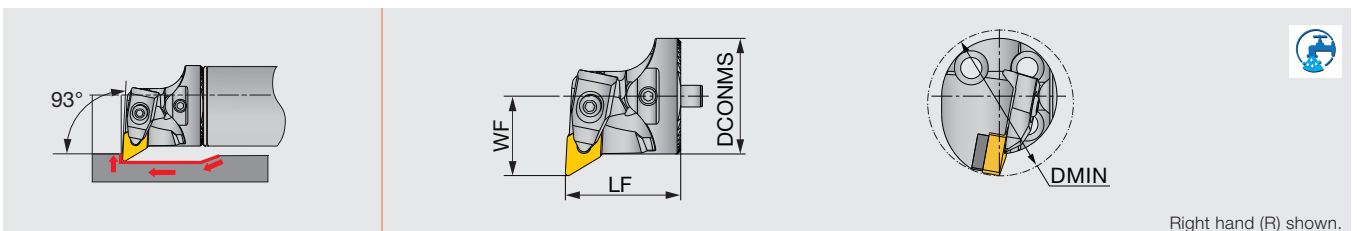

Right hand (R) shown.

Designation	DMIN	DCONMS	WF	LF	Shank size	Insert
S32-DDUNR/L11T-H	40	32	22	32	D32	DN**1104...
S40-DDUNR/L15T-H	50	40	27	32	D40, D50, D60	DN**1504/06...

Note: When using a right or left hand insert, the right hand insert (R) is used for the left hand toolholders (DDUNL** type), and the left hand insert (L) is used for the right hand toolholders (DDUNR** type).

S-DVUNR/L-H

Double clamp interchangeable boring heads for negative 35° rhombic inserts

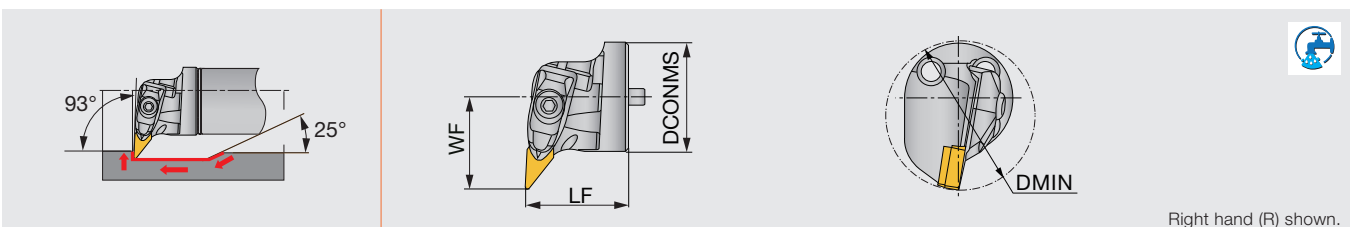

Right hand (R) shown.

Designation	DMIN	DCONMS	WF	LF	Shank size	Insert
S40-DVUNR/L16T-H	56	40	34	38	D40, D50, D60	VN**1604...

S-SCLXR/L-H

Screw-on clamp exchangeable boring head, for CXMU inserts

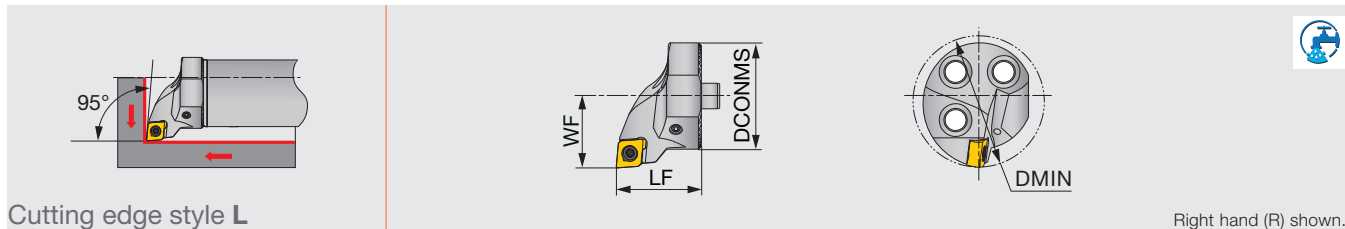

Cutting edge style L

Right hand (R) shown.

Designation	DMIN	DCONMS	WF	LF	Shank	Insert
S25-SCLXR/L06-H	32	25	17	20	D25	CXMU...
S32-SCLXR/L06-H	40	32	22	32	D32	CXMU...
S40-SCLXR/L06-H	50	40	27	32	D40, D50, D60	CXMU...

Note: Use right-hand toolholders (SCLXR**) with left-hand inserts (L); and left-hand toolholders (SCLXL**) with right-hand inserts (R).

S-SDXXR/L-H

Screw-on clamp exchangeable boring head, for DXG/MU inserts

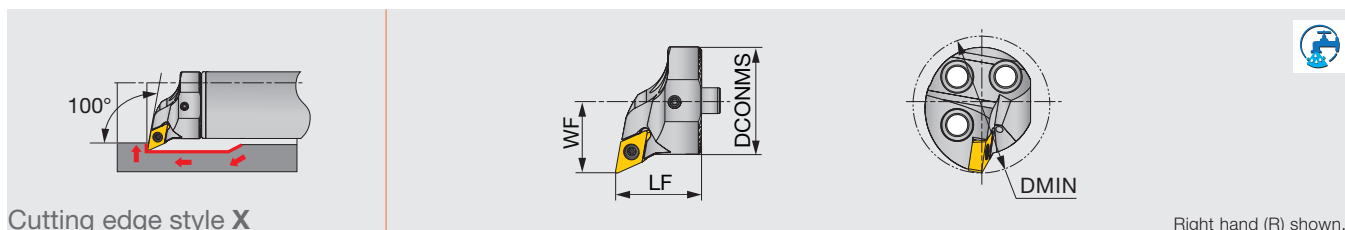

Cutting edge style X

Right hand (R) shown.

Designation	DMIN	DCONMS	WF	LF	Shank	Insert
S25-SDXXR/L07-H	32	25	17	20	D25	DXG/MU...
S32-SDXXR/L07-H	40	32	22	32	D32	DXG/MU...
S40-SDXXR/L07-H	50	40	27	32	D40, D50, D60	DXG/MU...

Note: Use right-hand toolholders (SDXXR**) with left-hand inserts (L); and left-hand toolholders (SDXXL**) with right-hand inserts (R).

S-SWLXR/L-H

Screw-on clamp exchangeable boring head, for WXGU inserts

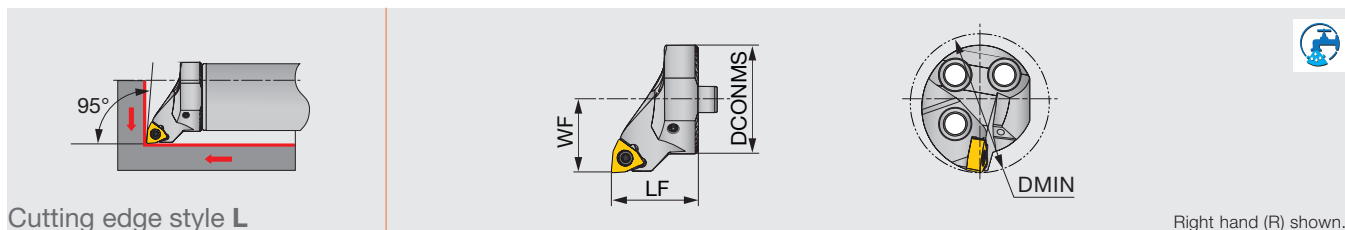

Cutting edge style L

Right hand (R) shown.

Designation	DMIN	DCONMS	WF	LF	Shank	Insert
S25-SWLXR/L04-H	32	25	17	20	D25	WXGU...
S32-SWLXR/L04-H	40	32	22	32	D32	WXGU...
S40-SWLXR/L04-H	50	40	27	32	D40, D50, D60	WXGU...

Note: Use right-hand toolholders (SWLXR**) with left-hand inserts (L); and left-hand toolholders (SWLXL**) with right-hand inserts (R).

S-SXUOR05-H

Screw-on clamp exchangeable boring head, for XOMU inserts

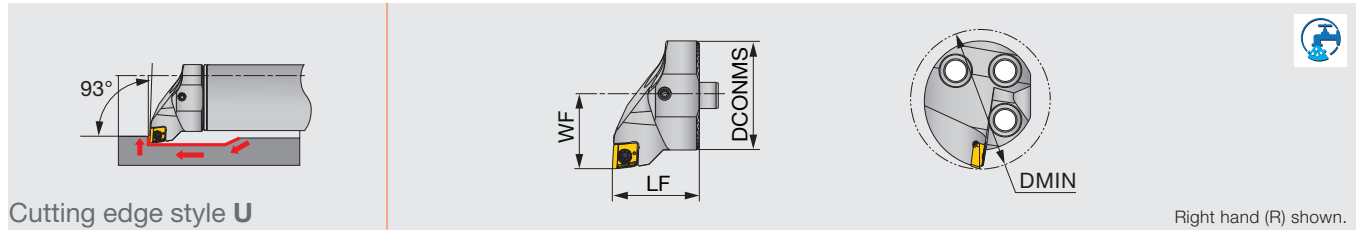

Designation	DMIN	DCONMS	WF	LF	Shank	Insert
S20-SXUOR05-H	25	20	13	20	D20	XOMU...
S25-SXUOR05-H	32	25	17	20	D25	XOMU...

S-PCLNR/L-H

Lever-lock clamp exchangeable boring head, for negative 80° rhombic inserts

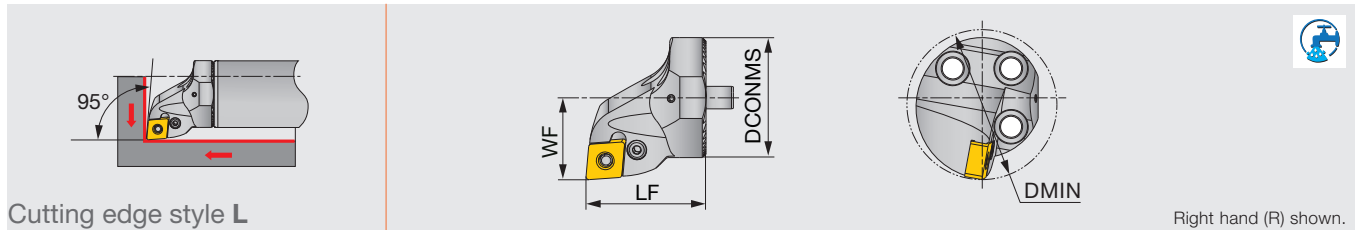

Designation	DMIN	DCONMS	WF	LF	Shank	Insert
S32-PCLNR/L09-H	40	32	22	32	D32	CNMG0904...
S40-PCLNR/L09-H	50	40	27	32	D40, D50, D60	CNMG0904...

Note: Use right-hand toolholders (PCLNR**) with left-hand inserts (L); and left-hand toolholders (PCLNL**) with right-hand inserts (R).

S-PTFNR/L-H

Lever-lock clamp exchangeable boring head, for negative 60° triangular inserts

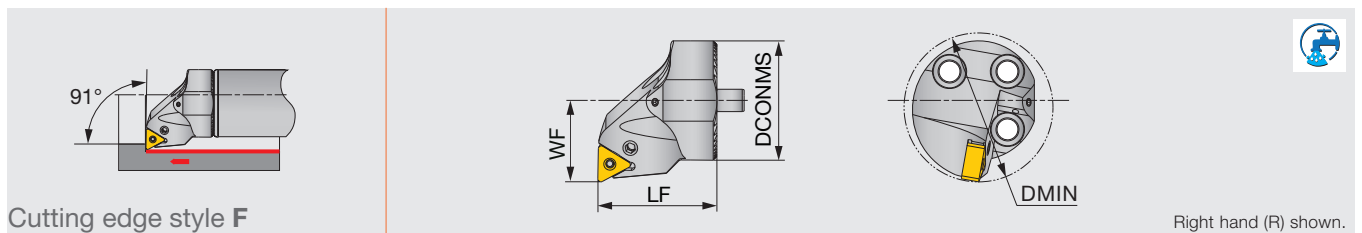

Designation	DMIN	DCONMS	WF	LF	Shank	Insert
S32-PTFNR/L11-H	40	32	22	32	D32	TNMG1104...
S40-PTFNR/L11-H	50	40	27	32	D40, D50, D60	TNMG1104...

Note: Use right-hand toolholders (PTFNR**) with left-hand inserts (L); and left-hand toolholders (PTFNL**) with right-hand inserts (R).

S-STFPR/L-H

Screw-on clamp exchangeable boring head, for positive 60° triangular inserts

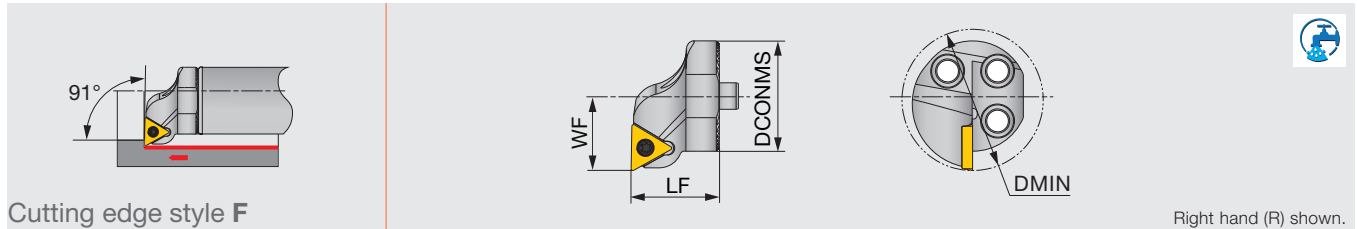

Designation	DMIN	DCONMS	WF	LF	Shank	Insert
S16-STFPR/L09-H	20	16	11	20	D16	TPMT0902...
S16-STFPR/L11-H	20	16	11	20	D16	TPMT1102...
S20-STFPR/L11-H	25	20	13	20	D20	TPMT1102...
S25-STFPR/L11-H	32	25	17	20	D25	TPMT1102...
S32-STFPR/L16-H	40	32	22	32	D32	TPMT16T3...
S40-STFPR/L16-H	50	40	27	32	D40, D50, D60	TPMT16T3...

Note: Use right-hand toolholders (STFPR**) with left-hand inserts (L); and left-hand toolholders (STFPL**) with right-hand inserts (R).

S-SNR-H

TUNGTHREAD

Screw-on clamp exchangeable boring head, for threading inserts

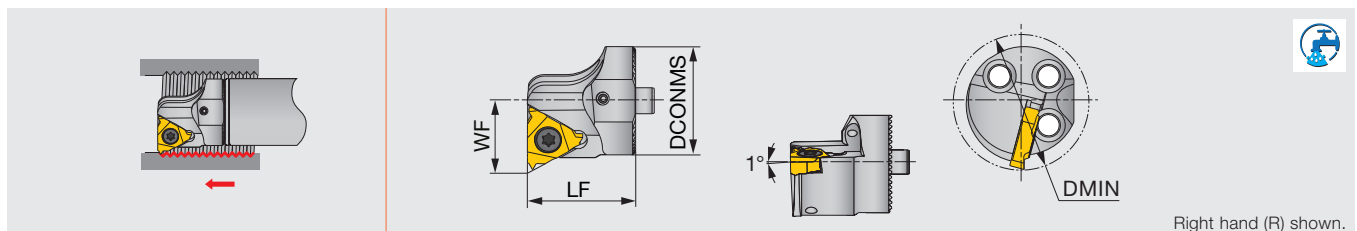

Designation	DMIN	DCONMS	WF	LF	Shank	Insert
S20-SNR16-H	25	20	14	25	D20	16IR...
S25-SNR16-H	32	25	17	25	D25	16IR...
S32-SNR16-H	40	32	22	32	D32	16IR...
S40-SNR16-H	50	40	27	32	D40, D50, D60	16IR...

S-QSIR/L-H

BOREMEISTER

Exchangeable boring head, for internal grooving

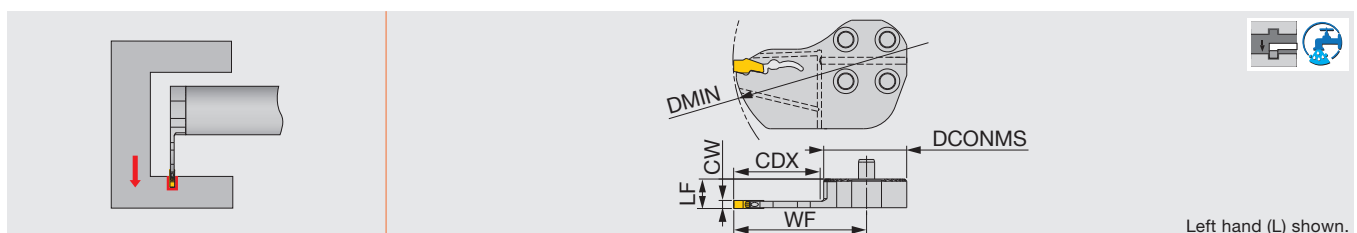

Designation	CW	CDX	DMIN	DCONMS	Seat size	LF	WF	Shank
S25-QSIR/L2T26D550-H	2	26	55	25	2	8.5	40.1	D25
S25-QSIR/L3T26D550-H	3	26	55	25	3	9	40.1	D25
S32-QSIR/L3T32D700-H	3	32	70	32	3	11	49.6	D32
S32-QSIR/L4T32D700-H	4	32	70	32	4	11.5	49.6	D32

Please refer to the BoreMeister Tungaloy Report (TR517) for shank information that is applicable to the head.

SHANKS

Straight Shank

Anti-vibration bars with through coolant for interchangeable turning heads

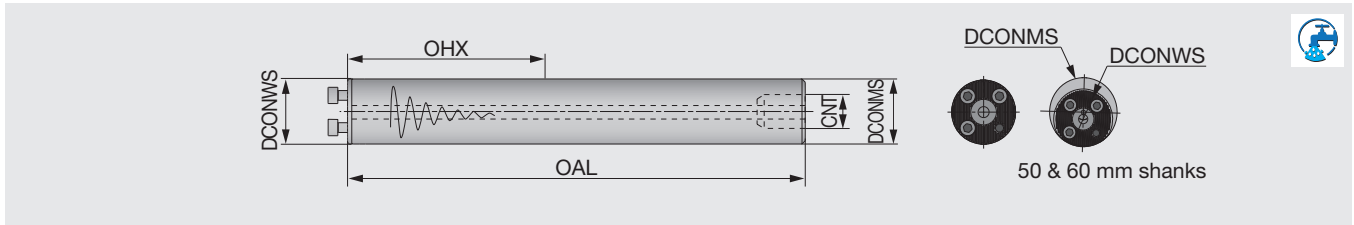

Designation	Material	DCONWS	DCONMS	OAL	OHX	CNT
D16-L156-7D-C	Steel	16	16	156.3	92	G1/8
G16-L204-10D-E	Carbide	16	16	204.3	140	-
D20-L200-7D-C	Steel	20	20	200.3	120	G1/4
G20-L260-10D-E	Carbide	20	20	260.3	180	-
D25-L255-7D-C	Steel	25	25	257.5	155	G1/4
D25-L330-10D-C	Steel	25	25	332.5	230	G1/4
D32-L320-7D-C	Steel	32	32	323	192	G3/8
D32-L416-10D-C	Steel	32	32	419	288	G3/8
D40-L408-7D-C	Steel	40	40	411	248	G1/2
D40-L528-10D-C	Steel	40	40	531	368	G1/2
D50-L518-7D-C	Steel	40	50	523	318	G1/2
D50-L668-10D-C	Steel	40	50	673	468	G1/2
D60-L628-7D-C	Steel	40	60	633	388	G3/4
D60-L808-10D-C	Steel	40	60	813	568	G3/4

D#4D-SH

Steel shank for internal turning, with through coolant

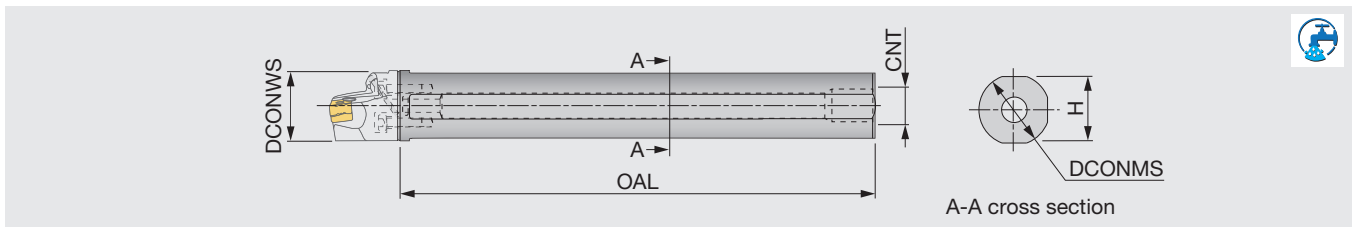

Designation	Material	DCONWS	DCONMS	OAL	CNT	H
D16-L105-4D-SH	Steel	16	16	105	UNC-2B 3/8"-16	15
D20-L140-4D-SH	Steel	20	20	140	UNFC-2B 3/8"-24	18
D25-L200-4D-SH	Steel	25	25	200	UNF-2B 1/2"-20	23
D32-L218-4D-SH	Steel	32	32	218	UNF-2B 1/2"-20	29
D40-L283-4D-SH	Steel	40	40	283	UNF-2B 1/2"-20	36

ADAPTER

C#-SH-CHP / C#-SH-E-CHP

PSC compatible adapter with steel or carbide core

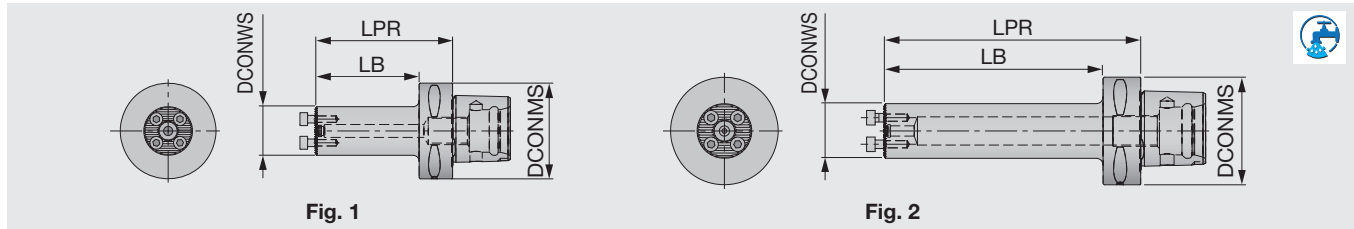

Designation	Material	DCONWS	DCONMS	LPR	LB	Fig
C4-SH-D16-2.5D-CHP	Steel	16	40	40	20	1
C4-SH-D20-2.5D-CHP	Steel	20	40	50	30	1
C4-SH-D25-2.5D-CHP	Steel	25	40	55	35	1
C4-SH-D32-2.5D-CHP	Steel	32	40	75	55	1
C4-SH-D40-3D-CHP	Steel	40	40	80	80	1
C6-SH-D20-5D-E-CHP	Carbide	20	63	100	78	2
C6-SH-D25-5D-E-CHP	Carbide	25	63	115	93	2
C6-SH-D32-5D-E-CHP	Carbide	32	63	150	128	2
C6-SH-D40-5D-E-CHP	Carbide	40	63	185	163	2

C6-9D-C

PSC adapter with anti vibration, L/D = 9

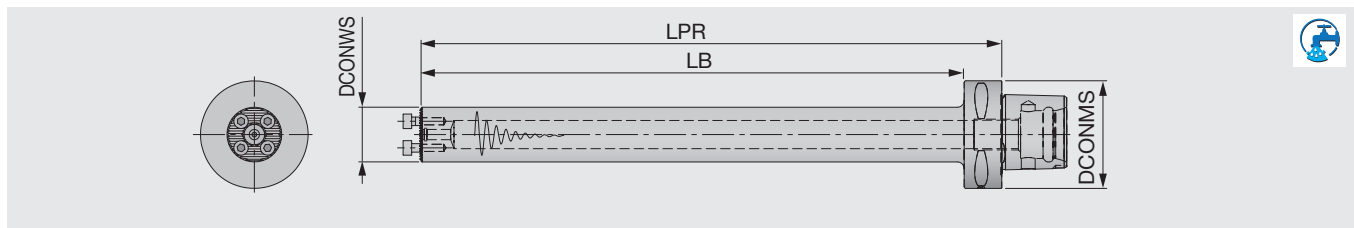

Designation	Material	DCONWS	DCONMS	LPR	LB	WT (kg)
C6-D25-L230-9D-C	Steel	25	63	230.5	200.1	1.65
C6-D32-L288-9D-C	Steel	32	63	288.5	259.5	2.73
C6-D40-L368-9D-C	Steel	40	63	368.5	339	4.45

SLEEVE

RSL sleeve

Split sleeve for anti-vibration bar

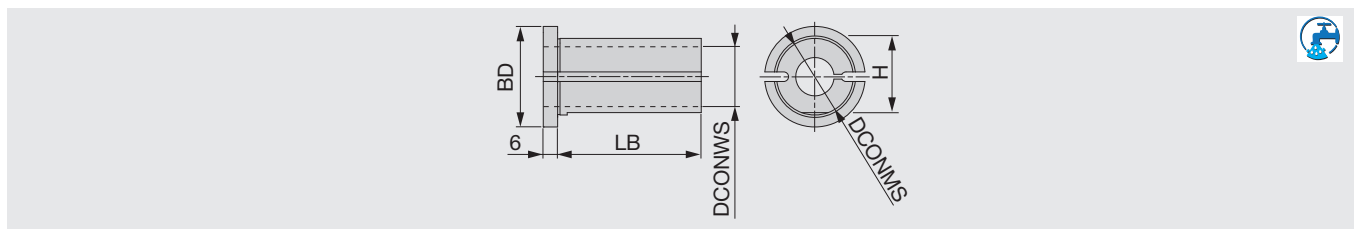

Designation	DCONWS	DCONMS	BD	LB	H
RSL-32-16-L66	16	32	42	60	31
RSL-32-20-L66	20	32	42	60	31
RSL-32-25-L66	25	32	42	60	31
RSL-40-16-L76	16	40	50	70	38.5
RSL-40-20-L76	20	40	50	70	38.5
RSL-40-25-L76	25	40	50	70	38.5

AVC-SET

Center height set up device

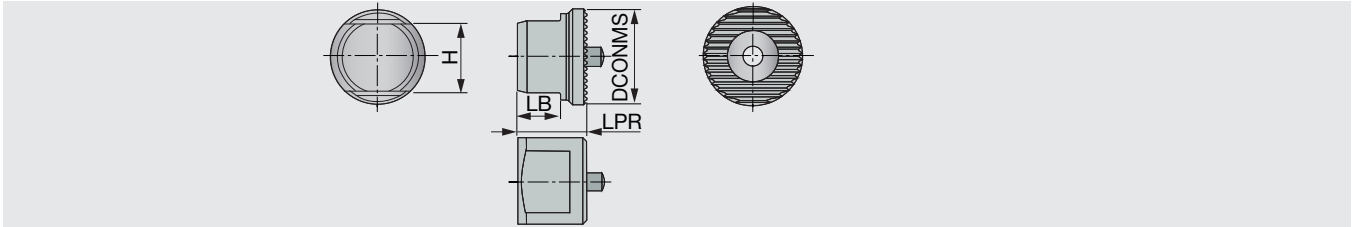

Designation	DCONMS	H	LPR	LB	Applicable shank
AVC-SET 16-25	20	15	14.5	8.9	16, 20, 25
AVC-SET 32-60	29	16	17.5	11.43	32, 40, 50, 60

TINY^{INI}TURN

Internal turning

MINIATURE SOLID BORING TOOLS FOR HIGH ACCURACY

ADD efficiency and profitability to your small boring operations as small as $\varnothing 0.6$ mm





- Ingenious through-coolant sleeve design optimally directs 4 streams of coolant jets close to the cutting zone, providing long tool life, controlled chips formation and evacuation for better part quality.



- New **SH725** grade provides a good combination of wear and fracture resistance, ensuring long tool life and wear prediction.
- Expanded indexable type boring bars, and inserts with 3D chip breaker for better chip control.
- Ideal for machining extremely small diameter bores in a wide range of materials.

Lineup

Solid bars

- Available for boring, profiling, chamfering, threading, and grooving

Sleeves

- Available in sleeve that accepts both 4 mm and 7 mm diameter boring bars, dedicated sleeve for internal coolant supply, collet chuck sleeve, and sleeve with four coolant holes
- Sleeve shank diameter range: 12 - 25.4 mm

Grade

- **SH725** : Well balanced combination of the latest coating layer dedicated for boring applications and tough carbide substrate provides long tool life

Scan this QR code to find out more about this tool!



SOLID BARS

TBTR/L

Solid boring bar for boring, profiling, and chamfering

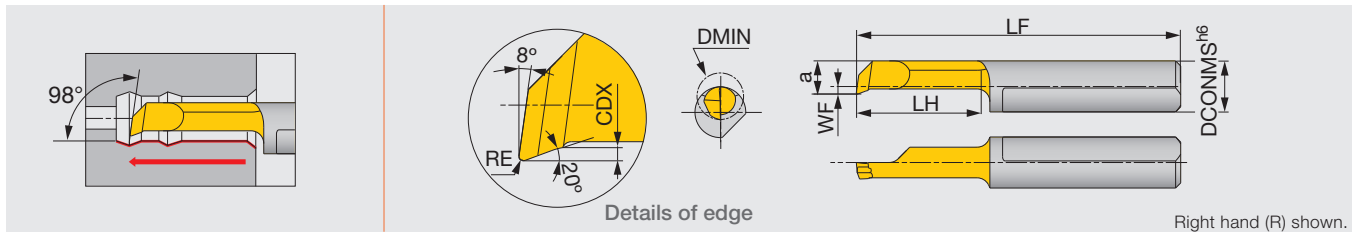

Designation	SH725	DMIN	DCONMS	WF	a	LF	LH	CDX	RE ^{+0.05} ₀
TBTR04045005-D010	●	1	4	-1.1	0.9	21	4.5	0.1	0.05
TBTR04065005-D010	●	1	4	-1.1	0.9	23	6.5	0.1	0.05
TBTR04040005-D020	●	2	4	-0.3	1.7	20.5	4	0.1	0.05
TBTR04090005-D020	●	2	4	-0.3	1.7	25.5	9	0.1	0.05
TBTR04140005-D020	●	2	4	-0.3	1.7	30.5	14	0.1	0.05
TBTR/L04090010-D028	●	2.8	4	0.9	2.6	25.5	9	0.2	0.1
TBTR04150010-D028	●	2.8	4	0.9	2.6	31.5	15	0.2	0.1
TBTR04190010-D028	●	2.8	4	0.9	2.6	35.5	19	0.2	0.1
TBTR04090010-D040	●	4	4	1.5	3.5	25.5	9	0.3	0.1
TBTR04150010-D040	●	4	4	1.5	3.5	31.5	15	0.3	0.1
TBTR04190010-D040	●	4	4	1.5	3.5	35.5	19	0.3	0.1
TBTR04230010-D040	●	4	4	1.5	3.5	39.5	23	0.3	0.1
TBTR04270010-D040	●	4	4	1.5	3.5	43.5	27	0.3	0.1
TBTR07090015-D050	●	5	7	0.9	4.4	25	9	0.5	0.15
TBTR07140015-D050	●	5	7	0.9	4.4	30	14	0.5	0.15
TBTR07190015-D050	●	5	7	0.9	4.4	35	19	0.5	0.15
TBTR07240015-D050	●	5	7	0.9	4.4	40	24	0.5	0.15
TBTR07290015-D050	●	5	7	0.9	4.4	45	29	0.5	0.15
TBTR07340015-D050	●	5	7	0.9	4.4	50	34	0.5	0.15
TBTR07140015-D060	●	6	7	1.8	5.3	30	14	0.5	0.15
TBTR/L07210015-D060	●	6	7	1.8	5.3	37	21	0.5	0.15
TBTR07240015-D060	●	6	7	1.8	5.3	40	24	0.5	0.15
TBTR07290015-D060	●	6	7	1.8	5.3	45	29	0.5	0.15
TBTR07340015-D060	●	6	7	1.8	5.3	50	34	0.5	0.15
TBTR07410015-D060	●	6	7	1.8	5.3	57	41	0.5	0.15
TBTR07190015-D068	●	6.8	7	2.8	6.3	35	19	0.6	0.15
TBTR07240015-D068	●	6.8	7	2.8	6.3	40	24	0.6	0.15
TBTR07290015-D068	●	6.8	7	2.8	6.3	45	29	0.6	0.15
TBTR07340015-D070	●	7	7	2.8	6.3	50	34	0.6	0.15
TBTR07390015-D070	●	7	7	2.8	6.3	55	39	0.6	0.15
TBTR07440015-D070	●	7	7	2.8	6.3	60	44	0.6	0.15
TBTR07490015-D070	●	7	7	2.8	6.3	65	49	0.6	0.15

● : Will be released in December 2021.

TBPR

Solid boring bar for boring and chamfering

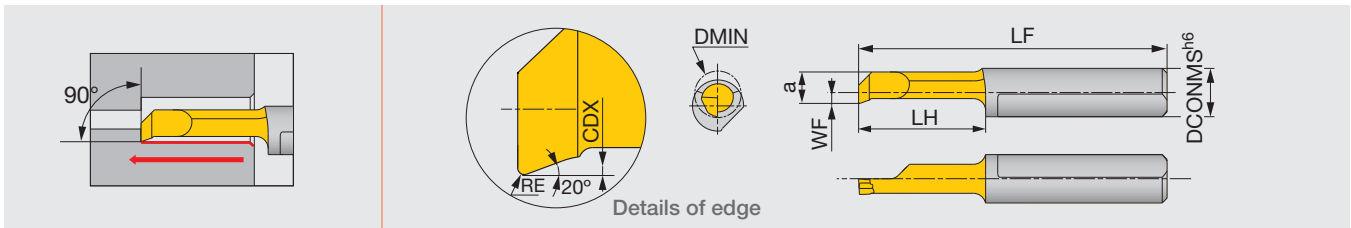

Designation	SH725	DMIN	DCONMS	WF	a	LF	LH	CDX	RE ^{+0.05} ₀
TBPR04090010-D028	●	2.8	4	0.9	2.6	25.5	9	0.2	0.1
TBPR04150010-D040	●	4	4	1.5	3.5	31.5	15	0.3	0.1
TBPR07140015-D050	●	5	7	0.9	4.4	30	14	0.5	0.15
TBPR07190015-D050	●	5	7	0.9	4.4	35	19	0.5	0.15

● : Will be released in December 2021.

Turning

TBUR

Solid boring bar for back boring and chamfering

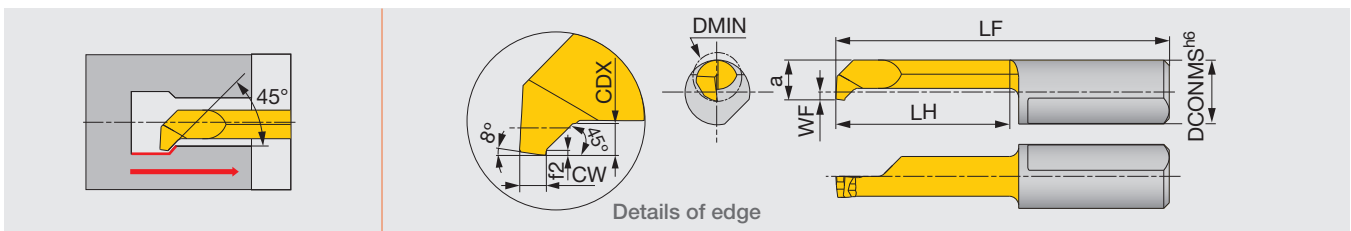

Designation	SH725	DMIN	DCONMS	WF	a	LF	LH	f2	CDX	CW ^{+0.05} ₀
TBUR07140010-D050	●	5	7	0.9	4.4	30	14	0.2	1	1
TBUR07190010-D050	●	5	7	0.9	4.4	35	19	0.2	1	1

● : Will be released in December 2021.

TBCR

Solid boring bar for boring and 45° chamfering

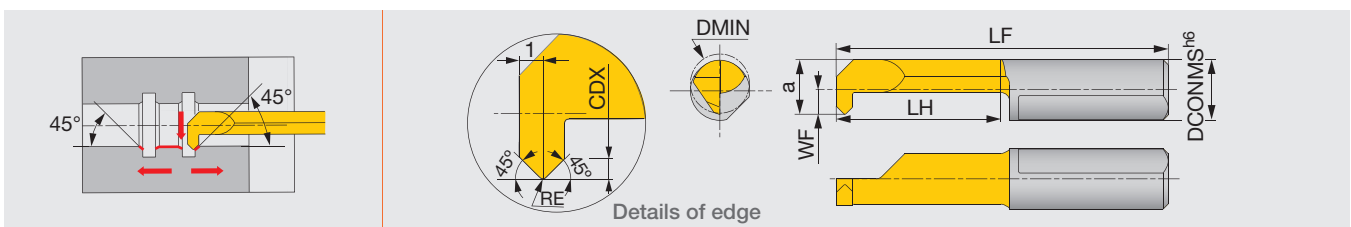

Designation	SH725	DMIN	DCONMS	WF	a	LF	LH	CDX	RE ^{+0.05} ₀
TBCR07140020-D050	●	5	7	0.9	4.4	30	14	0.7	0.2
TBCR07190020-D068	●	6.8	7	2.8	6.3	35	19	0.7	0.2

● : Will be released in December 2021.

TBBR

Solid boring bar for back boring

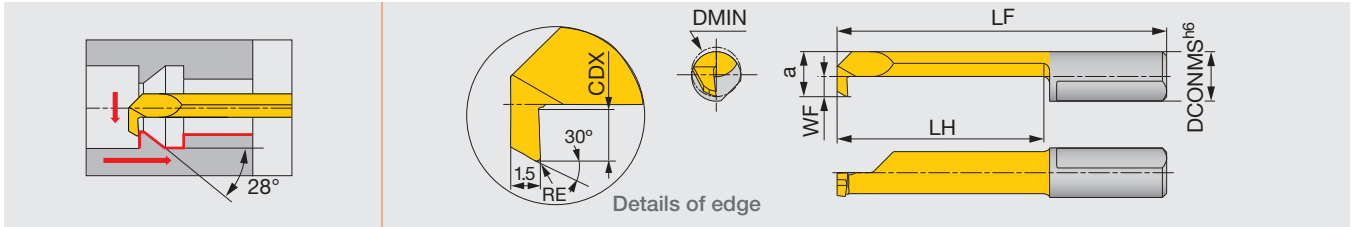

Designation	SH725	DMIN	DCONMS	WF	a	LF	LH	CDX	RE ^{+0.05} ₀
TBBR04140020-D030	●	3	4	0.6	2.6	30	14	0.5	0.2
TBBR04140015-D040	●	4	4	1.5	3.5	30	14	0.8	0.15
TBBR07190020-D050	●	5	7	0.9	4.4	35	19	1	0.2

● : Will be released in December 2021

TBIR

Solid boring bar for threading (metric)

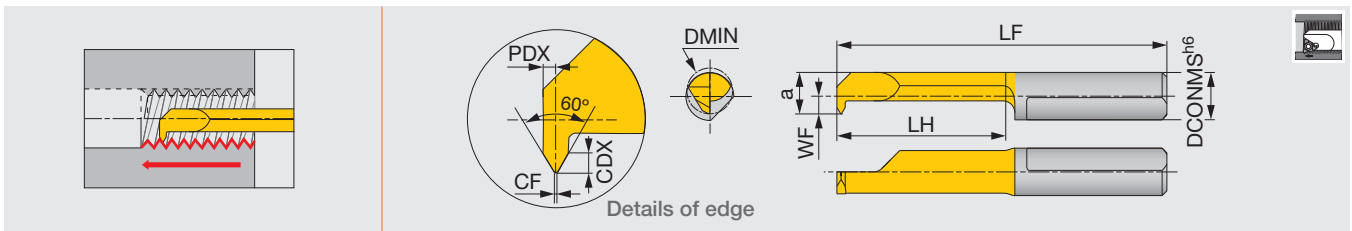

Designation	SH725	Pitch	DMIN	CF ⁰ _{-0.02}	DCONMS	WF	a	LF	LH	CDX	PDX
TBIR04140050-D040	●	0.5	4	0.06	4	1.5	3.5	30	14	0.3	0.35
TBIR07140050-D050	●	0.5	5	0.06	7	0.9	4.4	30	14	0.3	0.35
TBIR07140075-D050	●	0.75	5	0.09	7	0.9	4.4	30	14	0.4	0.45
TBIR07140100-D048	●	1	4.8	0.12	7	0.9	4.4	30	14	0.6	0.55
TBIR07140100-D060	●	1	6	0.12	7	1.8	5.3	30	14	0.6	0.55
TBIR07140150-D060	●	1.5	6	0.18	7	1.8	5.3	30	14	0.8	0.75

● : Will be released in December 2021

TBGR

Solid boring bar for internal grooving

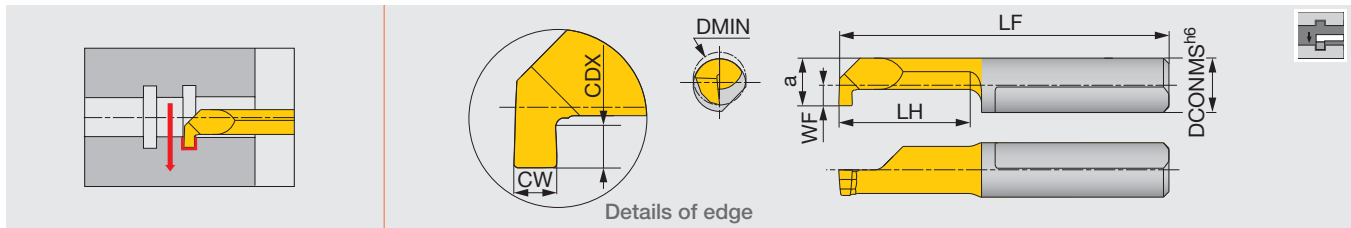

Designation	SH725	$CW^{+0.05}_0$	DMIN	DCONMS	WF	a	LF	LH	CDX
TBGR04100050-D020	●	0.5	2	4	-0.2	1.8	26	10	0.4
TBGR04090100-D040	●	1	4	4	1.5	3.5	25.5	9	0.8
TBGR04150100-D040	●	1	4	4	1.5	3.5	31.5	15	0.8
TBGR07090200-D050	●	2	5	7	0.9	4.4	25	9	1
TBGR07090100-D060	●	1	6	7	1.8	5.3	25	9	1.8
TBGR07140100-D060	●	1	6	7	1.8	5.3	30	14	1.8
TBGR07090150-D060	●	1.5	6	7	1.8	5.3	25	9	1.8
TBGR07090200-D060	●	2	6	7	1.8	5.3	25	9	1.8
TBGR07140200-D060	●	2	6	7	1.8	5.3	30	14	1.8
TBGR07090100-D068	●	1	6.8	7	2.7	6.2	25	9	2.5
TBGR07090150-D068	●	1.5	6.8	7	2.7	6.2	25	9	2.5
TBGR07140150-D068	●	1.5	6.8	7	2.7	6.2	30	14	2.5
TBGR07090200-D068	●	2	6.8	7	2.7	6.2	25	9	2.5
TBGR07140200-D068	●	2	6.8	7	2.7	6.2	30	14	2.5
TBGR07210200-D068	●	2	6.8	7	2.7	6.2	37	21	2.5
TBGR07290200-D068	●	2	6.8	7	2.7	6.2	45	29	2.5

* Corner radius : less than 0.1 mm.

● : Will be released in December 2021

Turning

TBFR

Solid boring bar for face grooving

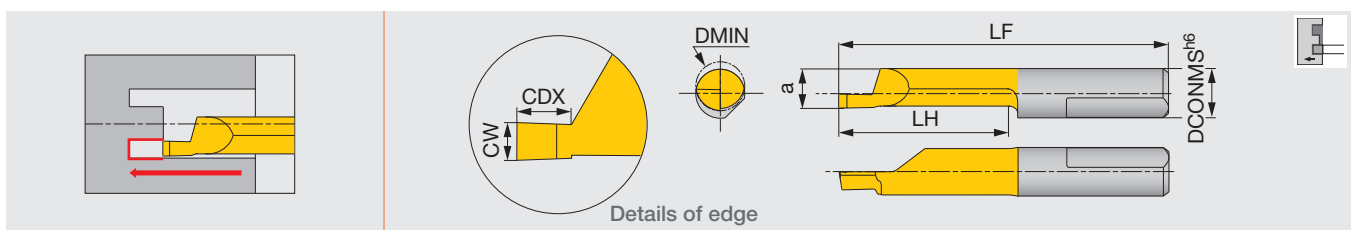

Designation	SH725	$CW^{+0.05}_0$	DMIN	DCONMS	a	LF	LH	CDX
TBFR07110100-D060	●	1	6	7	5.2	26	10	1.5
TBFR07110200-D060	●	2	6	7	5.2	26	10	3
TBFR07110100-D080	●	1	8	7	5.9	27	11	1.5
TBFR07110250-D080	●	2.5	8	7	5.9	27	11	3.5
TBFR07300300-D080	●	3	8	7	5.9	46	30	3.5
TBFR07200250-D150	●	2.5	15	7	5.9	36	20	20
TBFR07200300-D150	●	3	15	7	5.9	36	20	20
TBFR07300300-D150	●	3	15	7	5.9	46	30	30

* Corner radius : less than 0.1 mm.

● : Will be released in December 2021

TBSR

Solid boring bar for face grooving (for shaft)

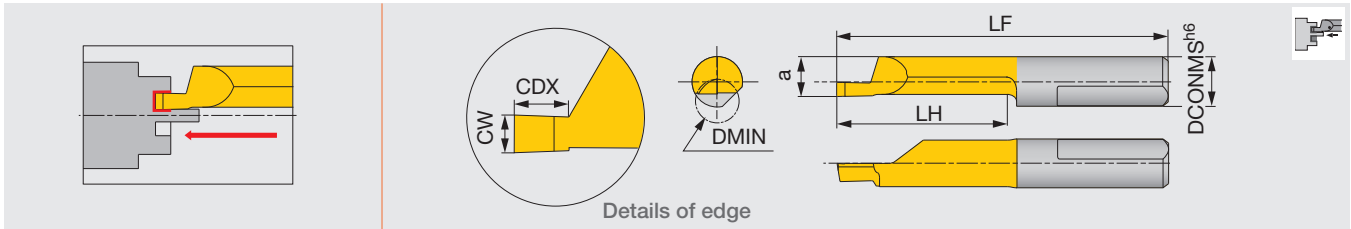

Designation	SH725	CW ^{+0.05} ₀	DMIN	DCONMS	a	LF	LH	CDX
TBSR07200200-D060	●	2	6	7	5.2	36	20	4

* Corner radius : less than 0.1 mm.

● : Will be released in December 2021

TBRR

Solid boring bar for boring and profiling

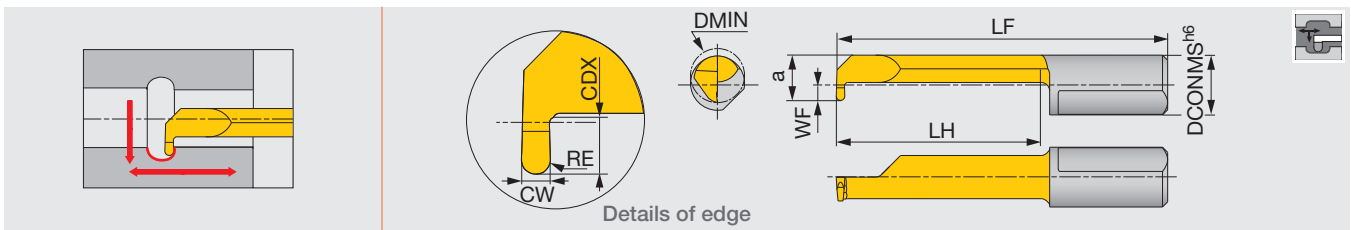

Designation	SH725	CW ^{+0.05} ₀	DMIN	DCONMS	WF	a	LF	LH	CDX	RE
TBRR07190050-D050	●	1	5	7	0.9	4.4	35	19	1	0.5
TBRR07240050-D060	●	1	6	7	1.8	5.3	40	24	1.8	0.5
TBRR07290050-D068	●	1	6.8	7	2.8	6.3	45	29	2.5	0.5

● : Will be released in December 2021

A/E-SEXPR

Screw-on boring bar, for positive 75° rhombic inserts

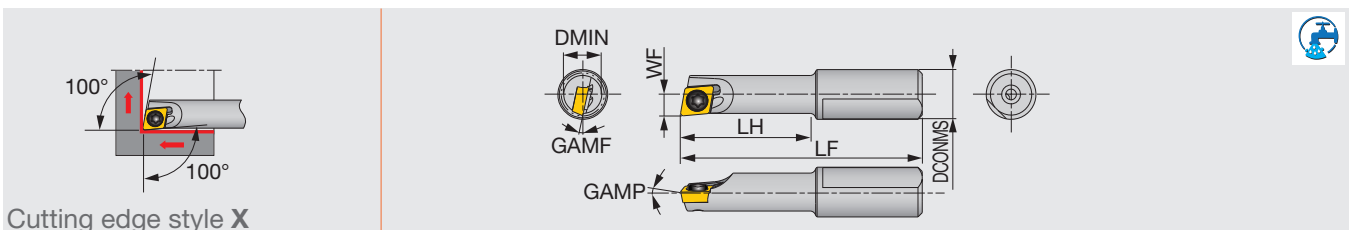

Designation	Material	DMIN	DCONMS	WF	LF	LH	GAMP	GAMP	RE**	Insert	Torque*
A07050-SEXPR03-3	Steel	5	7	2.5	31	15	0°	-13°	0.2	EPGT03X1...	0.6
A07060-SEXPR04-3	Steel	6	7	3.1	34	18	0°	-12°	0.2	EPGT0401...	0.6
E07050-SEXPR03-4	Carbide	5	7	2.5	37	20	0°	-13°	0.2	EPGT03X1...	0.6
E07050-SEXPR03-5	Carbide	5	7	2.5	42	25	0°	-13°	0.2	EPGT03X1...	0.6
E07060-SEXPR04-5	Carbide	6	7	3.1	46	30	0°	-12°	0.2	EPGT0401...	0.6

*Torque: Recommended clamping torque (N-m)

**RE : Standard corner radius

A/E-SEZPR

Screw-on boring bar, for positive 75° rhombic inserts

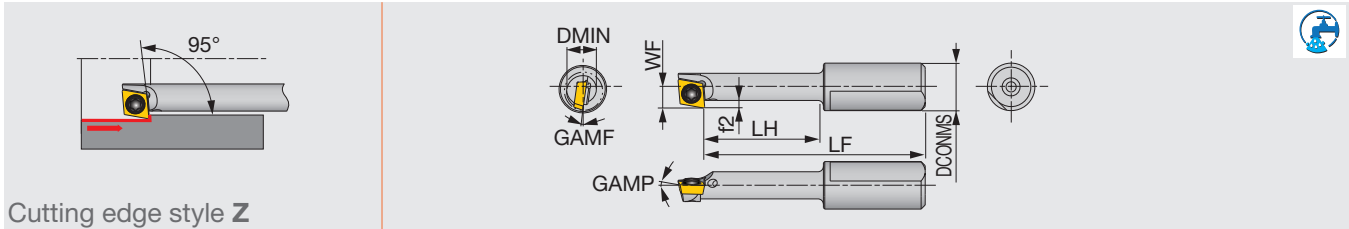

Cutting edge style Z

Designation	Material	DMIN	DCONMS	WF	LF	LH	f2	GAMP	GAMF	RE**	Insert	Torque*
A07055-SEZPR03-3	Steel	5.5	7	3.2	32.5	16.5	1.2	0°	-8°	0.2	EPGT03X1...	0.6
E07055-SEZPR03-5	Carbide	5.5	7	3.2	44.7	27.5	1.2	0°	-8°	0.2	EPGT03X1...	0.6

*Torque: Recommended clamping torque (N-m)

**RE : Standard corner radius

SLEEVE

JBBS-4N

Sleeve for internal coolant supply with 4 coolant holes

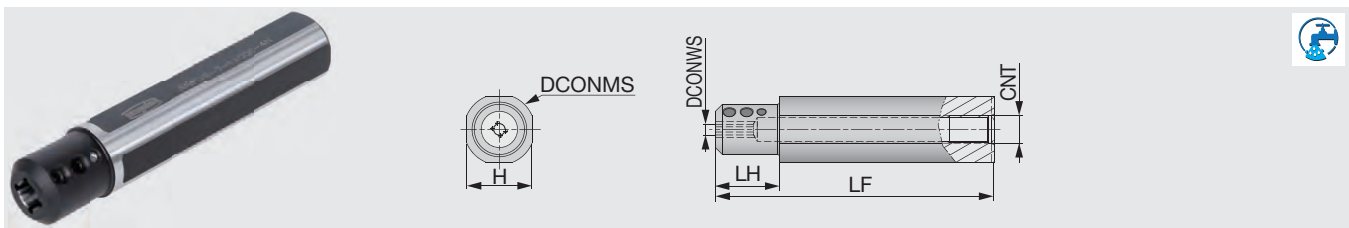

Designation	DCONMS	DCONWS	LF	LH	H	CNT
JBBS12-4-L80C-4N	12	4	80	10	10.3	Rc1/16
JBBS127-4-L80C-4N	12.7	4	80	10	11.6	Rc1/16
JBBS14-4-L80C-4N	14	4	80	10	12	Rc1/8
JBBS159-4-L100C-4N	15.875	4	100	10	14.58	Rc1/8
JBBS159-7-L100C-4N	15.875	7	100	10	14.58	Rc1/8
JBBS16-4-L100C-4N	16	4	100	10	15	Rc1/8
JBBS16-7-L100C-4N	16	7	100	10	15	Rc1/8
JBBS19-4-L100C-4N	19.05	4	100	20	17.2	Rc1/8
JBBS19-7-L100C-4N	19.05	7	100	20	17.2	Rc1/8
JBBS20-4-L100C-4N	20	4	100	20	18	Rc1/8
JBBS20-7-L100C-4N	20	7	100	20	18	Rc1/8
JBBS22-4-L100C-4N	22	4	100	20	20	Rc1/8
JBBS22-7-L100C-4N	22	7	100	20	20	Rc1/8
JBBS25-4-L100C-4N	25	4	100	23	23	Rc1/8
JBBS25-7-L100C-4N	25	7	100	23	23	Rc1/8
JBBS254-4-L100C-4N	25.4	4	100	23	23.4	Rc1/8
JBBS254-7-L100C-4N	25.4	7	100	23	23.4	Rc1/8

Scan this QR code for additional sleeve information.



MINIF^{ORCE}TURN / WAVYJOINT_{CBN}

Internal turning

UNIQUE NEW CBN INSERTS ENABLE HARD PART TURNING TO BE MORE RELIABLE, ECONOMICAL, AND PRODUCTIVE

ADD double-sided CBN inserts with WavyJoint brazing technology for light cutting action of positive inserts for hard turning applications





- Innovative insert geometry and secure insert clamping method ensures machining stability.
- Available in two grades: **BXA20** grade for general applications and **BXA10** grade suited for continuous cuts, providing reliability and long tool life from continuous to interrupted cuts.
- **HP type** chipbreaker guarantees short chips, ensuring good chip breaking and control at 0.2 mm and lighter d.o.c.
- Double-sided insert with six positive cutting edges for excellent cost-per-edge economy for reduced tool cost.

Lineup

Inserts

- **6QS-WXGQ...**
RE = 0.2 - 0.8 mm
- **6QS-WXGU**-HP**
RE = 0.4, 0.8 mm

Chipbreaker

- **HP type:** For chatter prevention and the finest machined surfaces. Suitable for turning operations of hardened steel materials

Toolholders



- **A-SWLXR/L...**
 - **E-SWLXR/L...**
- DCONMS = \varnothing 10 - \varnothing 20 mm

Grades

- **BXA10:** Incredible reliability in hardened steel turning. First choice for continuous to light interrupted cuts.
- **BXA20:** Incredible reliability in hardened steel turning. Covers a wide range of application areas from continuous to heavy interrupted cutting.

- : Continuous cutting
- ◐ : Light interrupted cutting
- ◑ : Heavy interrupted cutting

INSERT POSITIVE TYPE

Shape	Designation	Material										Dimension (mm)						Edge prep.					Wiper	Chipbreaker		
		P	M	K	N	S	H	BXA10	BXA20	No. of corners	LE	RE	IC	S	D1	Standard	SP	L	LF	LC	H					
		Steel	Stainless	Cast iron	Non-ferrous	Superalloy	Hard material	●	◐	6	1.8	0.2	6.35	3.18	2.7		○									
	6QS-WXGQ040302SPR	●	●																							
	6QS-WXGQ040302SPL	●	●																							
	6QS-WXGQ040304SPR	●	●																							
	6QS-WXGQ040304SPL	●	●																							
	6QS-WXGQ040308SPR	●	●																							
	6QS-WXGQ040308SPL	●	●																							
	6QS-WXGU040304R-HP	◐	◐																						○	
	6QS-WXGU040304L-HP	◐	◐																						○	
	6QS-WXGU040308R-HP	◐	◐																						○	
	6QS-WXGU040308L-HP	◐	◐																						○	

◐ : Will be released in December 2021

● : Line-up

TOOLHOLDERS

A/E-SWLXR/L

For trigon insert with 6 edges

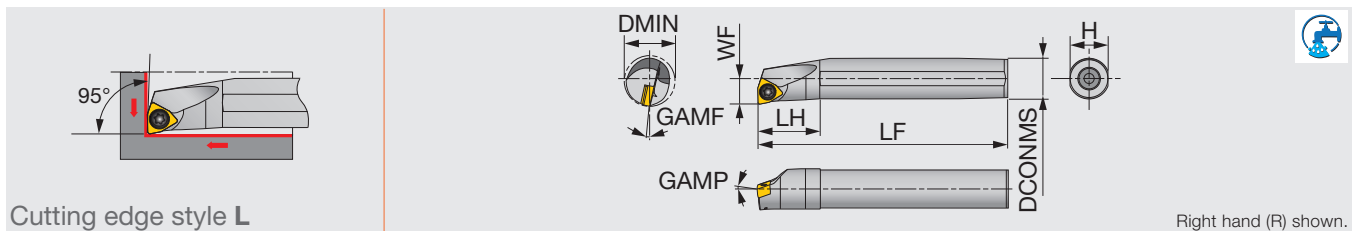

Cutting edge style L

Right hand (R) shown.

Designation	Material	DMIN	DCONMS	WF	LF	LH	H	GAMP	GAMP	RE**	Insert	Torque*
A10K-SWLXR/L04-D120	STEEL	12	10	6	125	20	9	-10	-16	0.4	WXGU0403**L/R (...)	0.9
A12M-SWLXR/L04-D140	STEEL	14	12	7	150	24	11	-10	-14	0.4	WXGU0403**L/R (...)	0.9
A16Q-SWLXR/L04-D180	STEEL	18	16	9	180	32	15	-10	-11	0.4	WXGU0403**L/R (...)	0.9
A20R-SWLXR/L04-D220	STEEL	22	20	11	200	36	18	-10	-10	0.4	WXGU0403**L/R (...)	0.9
E10M-SWLXR/L04-D120	CARBIDE	12	10	6	150	25	9	-10	-16	0.4	WXGU0403**L/R (...)	0.9
E12Q-SWLXR/L04-D140	CARBIDE	14	12	7	180	27	11	-10	-14	0.4	WXGU0403**L/R (...)	0.9
E16R-SWLXR/L04-D180	CARBIDE	18	16	9	200	32	15	-10	-11	0.4	WXGU0403**L/R (...)	0.9
E20S-SWLXR/L04-D220	CARBIDE	22	20	11	250	36	18	-10	-10	0.4	WXGU0403**L/R (...)	0.9

*Torque: Recommended torque (N-m) for clamping **RE: The holder measurements are true with this insert radius

Note: Use the right hand toolholder (R) for the left hand insert (L). Use the left hand toolholder (L) for the right hand insert (R)

STANDARD CUTTING CONDITIONS

ISO	Grade	Edge preparation	Workpiece condition	Cutting speed Vc (m/min)	Depth of cut ap (mm)	Feed f (mm/rev)
H	BXA10	No symbol	Continuous	100 - 230	0.05 - 0.5	0.03 - 0.3
			Light interrupted	100 - 230	0.05 - 0.5	0.03 - 0.2
		-HP	Continuous	100 - 230	0.05 - 0.2	0.03 - 0.2
	BXA20	No symbol	Continuous	60 - 180	0.05 - 0.5	0.03 - 0.3
			Interrupted	60 - 180	0.05 - 0.5	0.03 - 0.2
		-HP	Continuous	60 - 180	0.05 - 0.2	0.03 - 0.2

MODUM^{INI}TURN

External turning

INNOVATIVE MODULAR HEAD SYSTEM FOR SWISS MACHINES

ADD flexibility and productivity
to your turning operations

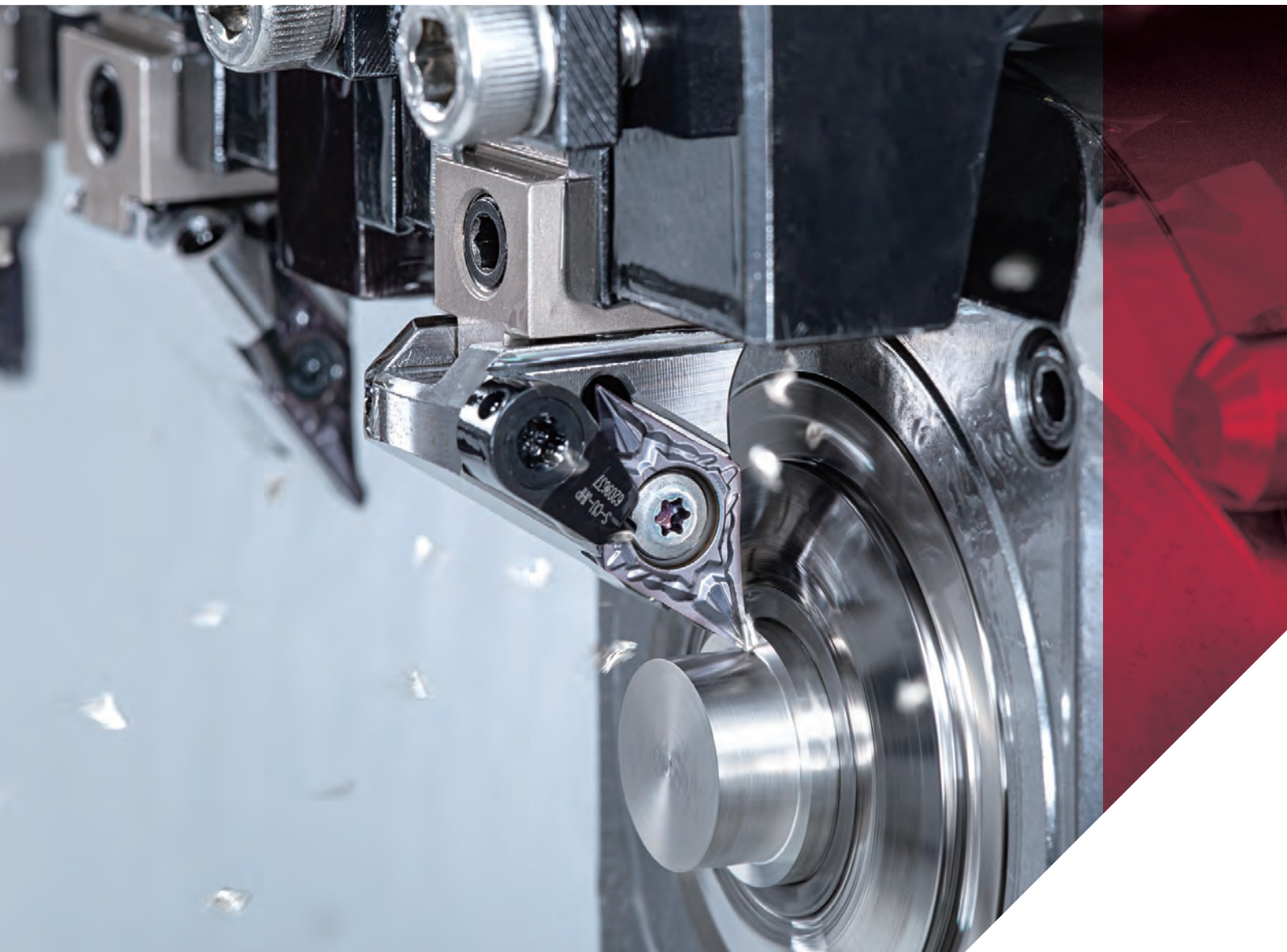

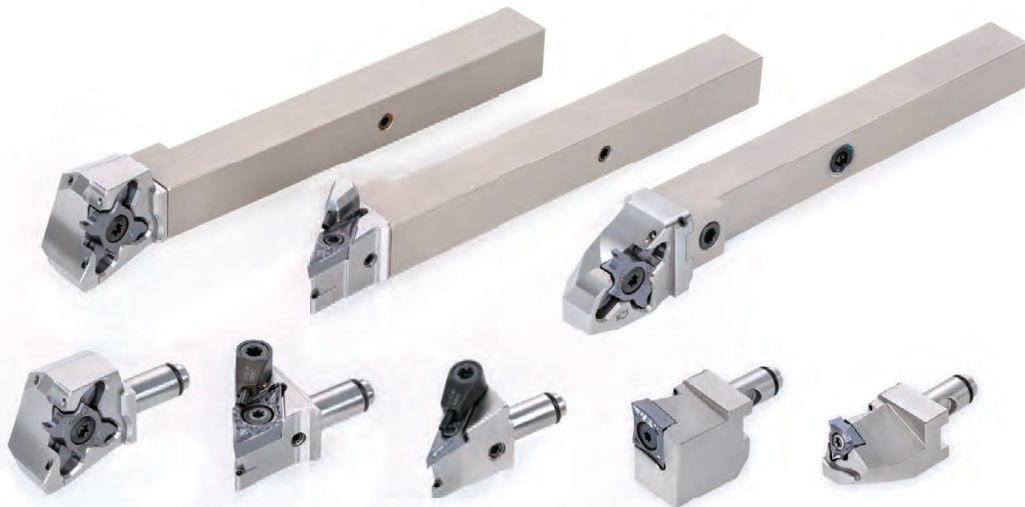

- Modularity and productivity with a wide selection of turning, grooving and threading heads.
- Substantially reduced setup time for maximum machine utilization.
- Quick tool change and setup is possible with simple exchanges of turning heads.
- Unique coupling method provides stable head-shank connection and secure insert edge position for good repeatability and accuracy.
- Positioning accuracy for the same insert: $\pm 5 \mu\text{m}$.
- **ModuMiniTurn** offers precision internal coolant delivery, which improves chip control and tool life.
- By feeding in the Y-axis direction, downward-facing chipbreaker directs the chip flow down and away from the cutting point.
- Many types of heads can be mounted on a single holder.

Lineup

Inserts

- **J-Series** for ISO insert
- **MiniForce-Turn** for double-sided positive inserts
- Y-axis heads for **J-Series**, **MiniForce-Turn**, and **TetraMini-Cut** for grooving and threading inserts

Shanks

- **QC-1212...**
- **QC-1212-CHP** (for precision internal coolant supply)

Scan this QR code to find out more about this tool!











Lineup

Shanks (size: 12 mm x 12 mm)

Overall length* (mm)	Without coolant hole	With coolant hole	Page
85	✓	✓	77
120	✓	✓	77

*With the head attached

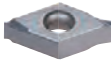
Modular heads

Tool series	Insert shape	Without coolant hole	With coolant hole	Page
J-SERIES	CC**09T3...	✓	✓	67 72 73
		✓	✓	
	DC**0702...	✓	✓	67 68
		✓	✓	
	DC**11T3...	✓	✓	67 68 73
		✓	✓	
	VB**1103...	✓	✓	68
		✓	✓	
	J10ER...	✓	-	69
		✓	-	
MINIF^{INI}TURN	WXGU0403**L...	✓	✓	69 74
		✓	✓	
	DXGU0703**L...	✓	✓	70 74 75
		✓	✓	
	VXGU09T2**L...	✓	✓	70 71
		✓	✓	
TETRAM^{INI}CUT	TC*18R/L...	✓	✓	71 72 75 76
		✓	✓	

MODULAR HEADS

QC12-JSCL2CR

J-SERIES

Screw-on modular head with 95° approach angle, for positive 80° rhombic inserts

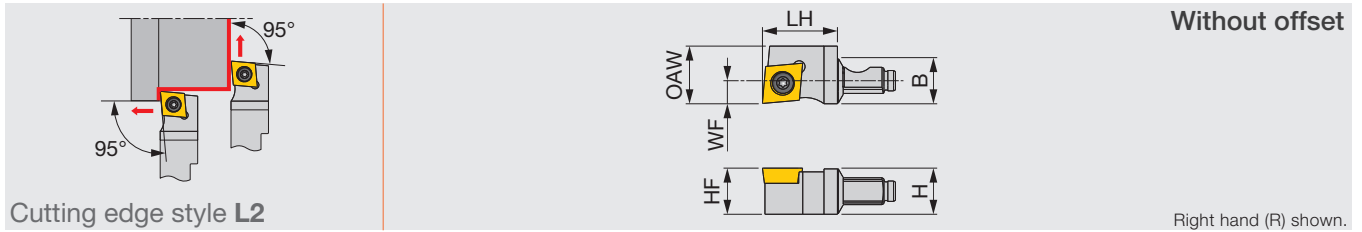

Designation	H	B	LH	HF	WF	OAW	RE**	Insert	Torque*
QC12-JSCL2CR09	12	12	19.5	12	6	15	0.2	CC**09T3...	1.2

*Torque: Recommended clamping torque (N-m)
**RE: Standard corner radius

QC12-JSCL2CR-CHP

J-SERIES

Screw-on modular head with 95° approach angle, for positive 80° rhombic inserts, with high pressure coolant capability

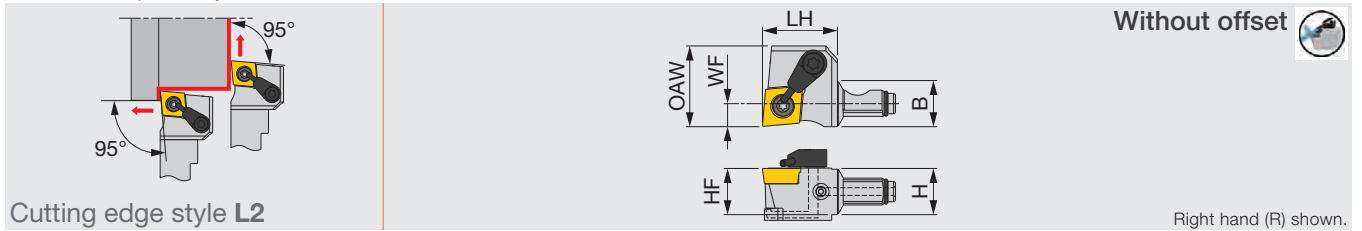

Designation	H	B	LH	HF	WF	OAW	RE**	Insert	Torque*
QC12-JSCL2CR09-CHP	12	12	19.5	12	6	21	0.2	CC**09T3...	1.2

Through-coolant head
*Torque: Recommended clamping torque (N-m)
**RE: Standard corner radius

QC12-JSDJ2CR

J-SERIES

Screw-on modular head with 93° approach angle, for positive 55° rhombic inserts

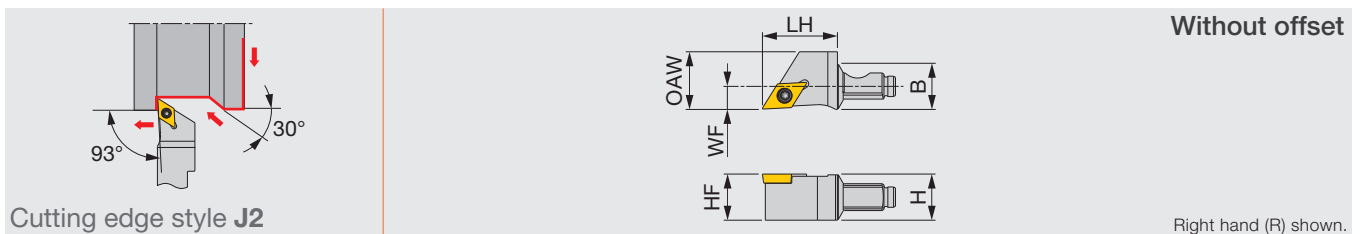

Designation	H	B	LH	HF	WF	OAW	RE**	Insert	Torque*
QC12-JSDJ2CR07	12	12	19.5	12	6	15	0.2	DC**0702...	1.2
QC12-JSDJ2CR11	12	12	19.5	12	6	15	0.2	DC**11T3...	1.2

*Torque: Recommended clamping torque (N-m)
**RE: Standard corner radius

QC12-JSDJ2CR-CHP

J-SERIES

Screw-on modular head with 93° approach angle, for positive 55° rhombic inserts, with high pressure coolant capability

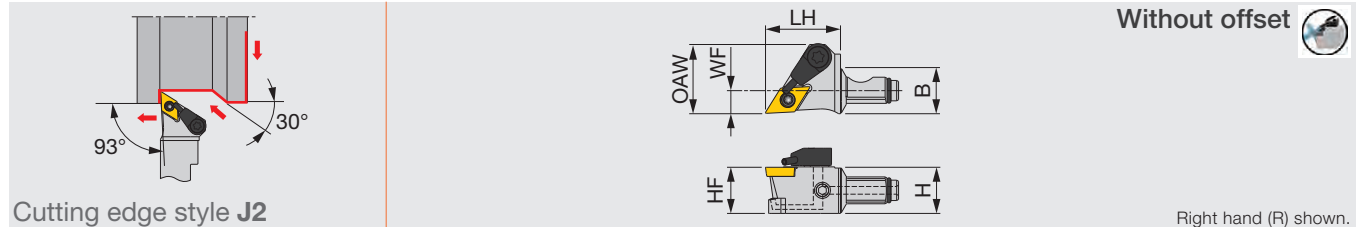

Without offset

Right hand (R) shown.

Designation	H	B	LH	HF	WF	OAW	RE**	Insert	Torque*
QC12-JSDJ2CR07-CHP	12	12	19.5	12	6	18	0.2	DC**0702...	1.2
QC12-JSDJ2CR11-CHP	12	12	19.5	12	6	21	0.2	DC**11T3...	1.2

Through-coolant head

*Torque: Recommended clamping torque (N-m)

**RE: Standard corner radius

QC12-JSVJ2BR

J-SERIES

Screw-on modular head with 93° approach angle, for positive 35° rhombic inserts

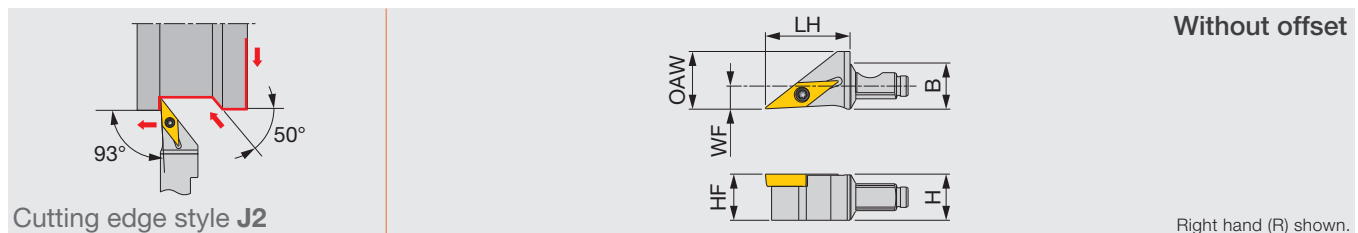

Without offset

Right hand (R) shown.

Designation	H	B	LH	HF	WF	OAW	RE**	Insert	Torque*
QC12-JSVJ2BR11	12	12	22	12	6	15	0.2	VB**1103...	1.2

*Torque: Recommended clamping torque (N-m) **RE: Standard corner radius

QC12-JSVJ2BR-CHP

J-SERIES

Screw-on modular head with 93° approach angle, for positive 35° rhombic inserts, with high pressure coolant capability

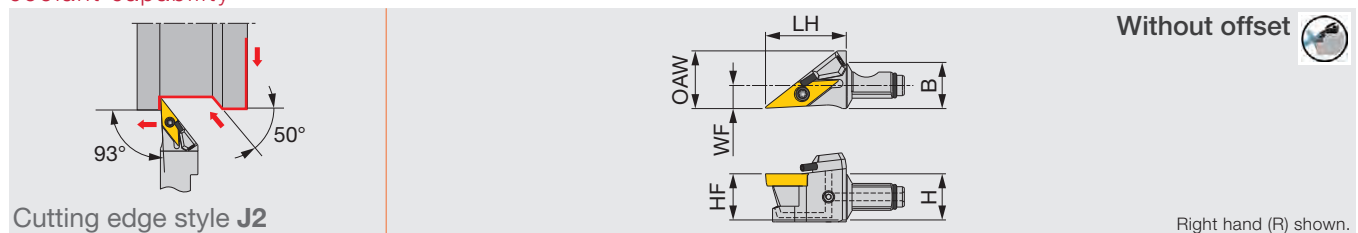

Without offset

Right hand (R) shown.

Designation	H	B	LH	HF	WF	OAW	RE**	Insert	Torque*
QC12-JSVJ2BR11-CHP	12	12	21	12	6	15	0.2	VB**1103...	1.2

Through-coolant head

*Torque: Recommended clamping torque (N-m) **RE: Standard corner radius

QC12-JSEGR

Screw-on modular head for back turning

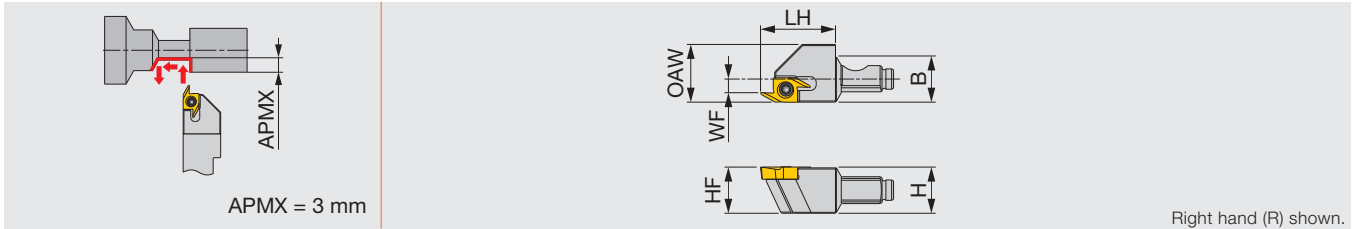

Designation	H	B	LH	HF	WF	OAW	Insert	Torque*
QC12-JSEGR10	12	12	19.5	12	3.5	15	J10ER...	1.2

*Torque: Recommended clamping torque (N-m)

Turning

QC12-JSWL2XR

Screw-on modular head with 95° approach angle, for WXGU inserts

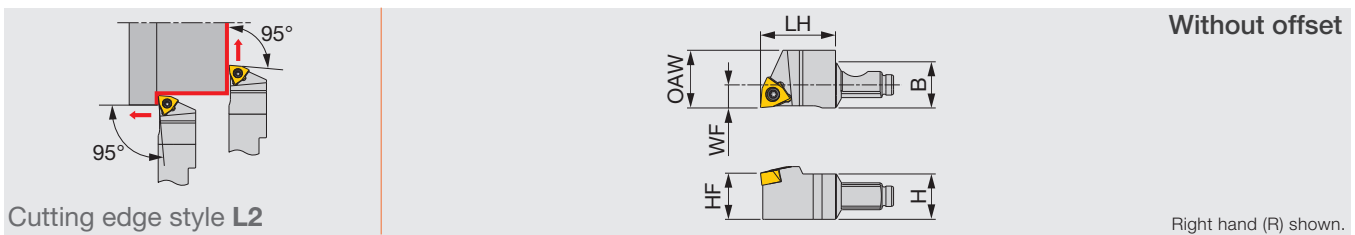

Designation	H	B	LH	HF	WF	OAW	RE**	Insert	Torque*
QC12-JSWL2XR04	12	12	19.5	12	6	15	0.2	WXGU0403**L...	0.9

Use right-hand toolholders (R) with left-hand inserts (L).

*Torque: Recommended clamping torque (N-m)

**RE: Standard corner radius

QC12-JSWL2XR-CHP

Screw-on modular head with 95° approach angle, for WXGU inserts, with high pressure coolant capability

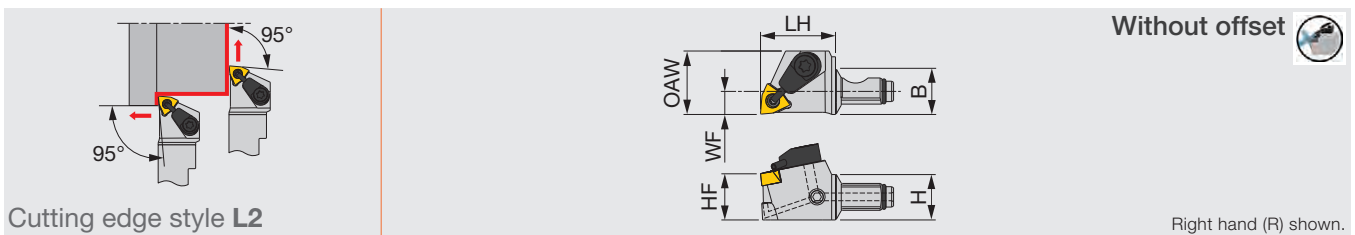

Designation	H	B	LH	HF	WF	OAW	RE**	Insert	Torque*
QC12-JSWL2XR04-CHP	12	12	19.5	12	6	16.5	0.2	WXGU0403**L...	0.9

Use right-hand toolholders (R) with left-hand inserts (L).

Through-coolant head

*Torque: Recommended clamping torque (N-m)

**RE: Standard corner radius

QC12-JSDJ2XR

Screw-on modular head with 93° approach angle, for DXGU inserts

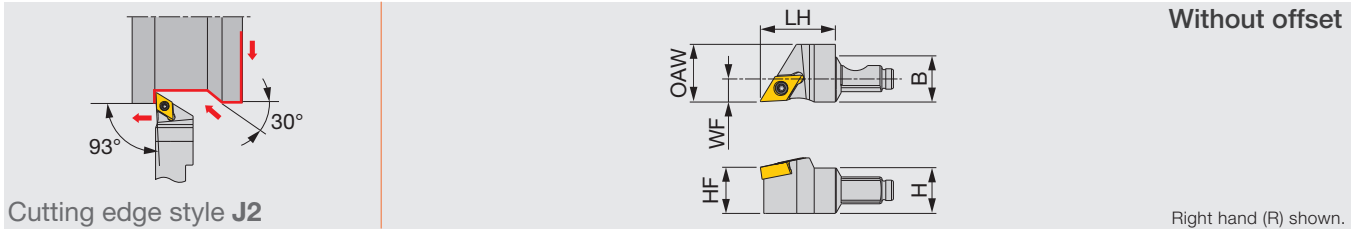

Designation	H	B	LH	HF	WF	OAW	RE**	Insert	Torque*
QC12-JSDJ2XR07	12	12	19.5	12	6	15	0.2	DXGU0703**L...	0.9

Use right-hand toolholders (R) with left-hand inserts (L).
 *Torque: Recommended clamping torque (N-m)
 **RE: Standard corner radius

QC12-JSDJ2XR-CHP

Screw-on modular head with 93° approach angle, for DXGU inserts, with high pressure coolant capability

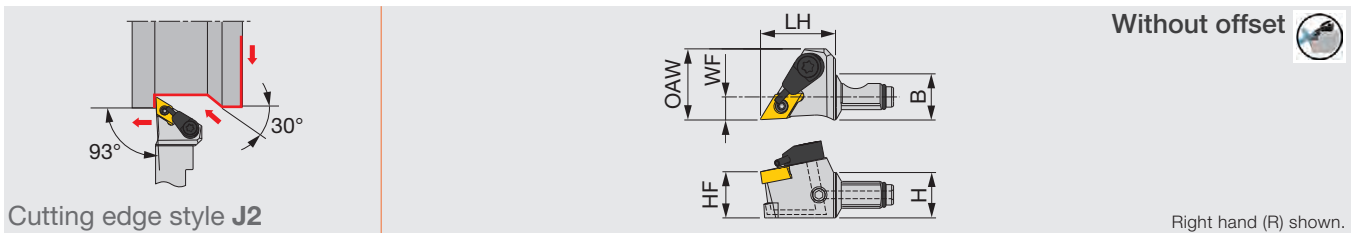

Designation	H	B	LH	HF	WF	OAW	RE**	Insert	Torque*
QC12-JSDJ2XR07-CHP	12	12	19.5	12	6	18.4	0.2	DXGU0703**L...	0.9

Use right-hand toolholders (R) with left-hand inserts (L).
 Through-coolant head
 *Torque: Recommended clamping torque (N-m)
 **RE: Standard corner radius

QC12-JSVJ2XR

Screw-on modular head with 93° approach angle, for VXGU inserts

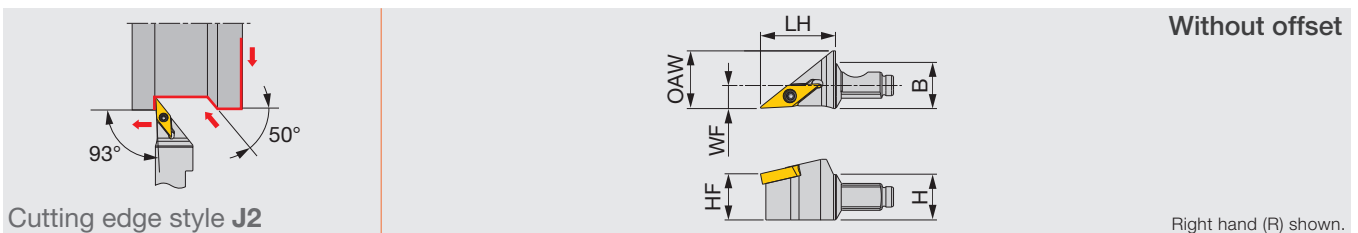

Designation	H	B	LH	HF	WF	OAW	RE**	Insert	Torque*
QC12-JSVJ2XR09	12	12	19.5	12	6	15	0.2	VXGU09T2**L...	0.9

Use right-hand toolholders (R) with left-hand inserts (L).
 *Torque: Recommended clamping torque (N-m)
 **RE: Standard corner radius

QC12-JSVJ2XR-CHP

Screw-on modular head with 93° approach angle, for VXGU inserts, with high pressure coolant capability

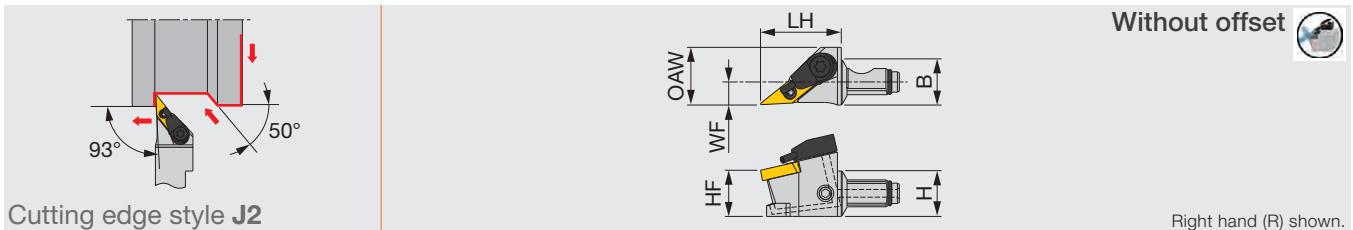

Cutting edge style **J2**

Right hand (R) shown.

Designation	H	B	LH	HF	WF	OAW	RE**	Insert	Torque*
QC12-JSVJ2XR09-CHP	12	12	21	12	6	15	0.2	VXGU09T2**L...	0.9

Use right-hand toolholders (R) with left-hand inserts (L).

Through-coolant head

*Torque: Recommended clamping torque (N·m)

**RE: Standard corner radius

QC12-STCR

Modular head for external grooving and threading

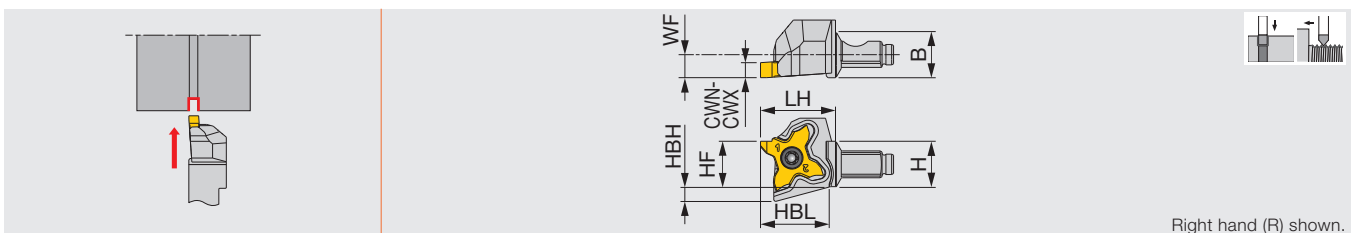

Right hand (R) shown.

Designation	CWN	CWX	H	B	LH	HF	HBH	HBL	WF	Insert	Torque*
QC12-STCR18	0.33	3	12	12	19.5	12	3.9	17.9	6	TC*18R...	1.2

The right hand insert (R) is used for the right hand toolholder (R).

*Torque: Recommended clamping torque (N·m)

QC12-STCR-CHP

Modular head for external grooving and threading, with high pressure coolant capability

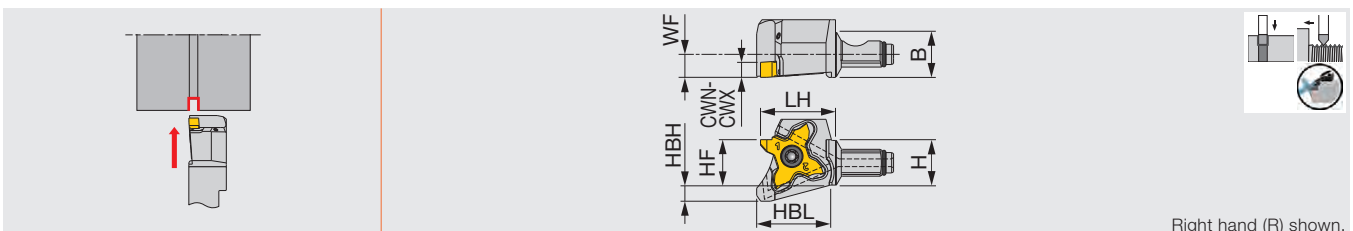

Right hand (R) shown.

Designation	CWN	CWX	H	B	LH	HF	HBH	HBL	WF	Insert	Torque*
QC12-STCR18-CHP	0.33	3	12	12	19.5	12	4.2	19.3	6	TC*18R...	1.2

The right hand insert (R) is used for the right hand toolholder (R).

Through-coolant head

*Torque: Recommended clamping torque (N·m)

Right-hand insert



TC*18R...

QC12-STCL

Modular head for external grooving and threading

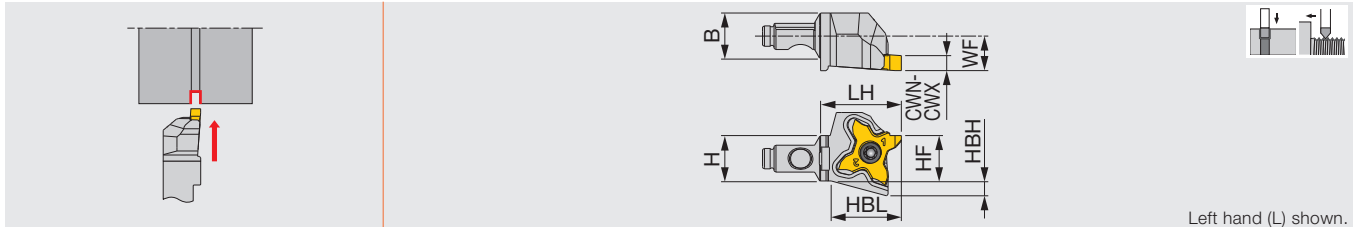

Designation	CWN	CWX	H	B	LH	HF	HBH	HBL	WF	Insert	Torque*
QC12-STCL18	0.33	3	12	12	21	12	3.9	18.3	9	TC*18L...	1.2

The left hand insert (L) is used for the left hand toolholder (L).
*Torque: Recommended clamping torque (N-m)

QC12-STCL-CHP

Modular head for external grooving and threading, with high pressure coolant capability

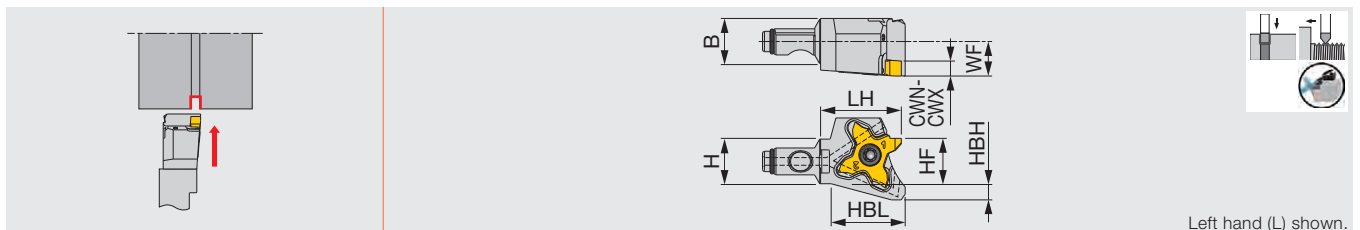

Designation	CWN	CWX	H	B	LH	HF	HBH	HBL	WF	Insert	Torque*
QC12-STCL18-CHP	0.33	3	12	12	21	12	4.2	19.3	9	TC*18L...	1.2

The left hand insert (L) is used for the left hand toolholder (L).
Through-coolant head
*Torque: Recommended clamping torque (N-m)

Left-hand insert



TC*18L...

QC12-JSCL2CR-Y

Screw-on Y-axis turning modular head with 95° approach angle, for positive 80° rhombic inserts

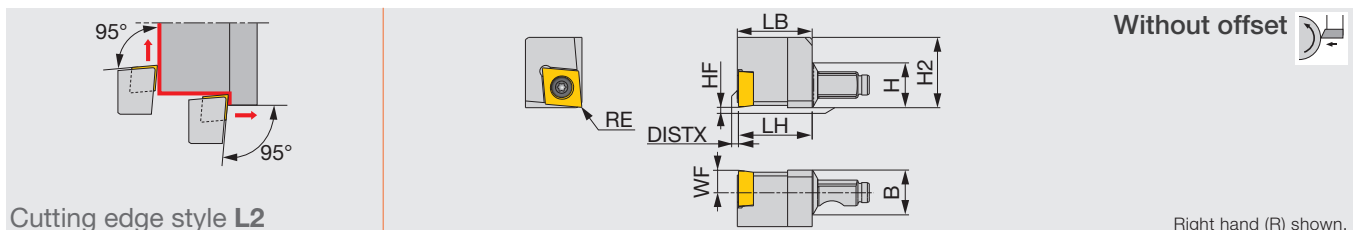

Designation	H	B	LH	HF	WF	LB	H2	DISTX	RE**	Insert	Torque*
QC12-JSCL2CR09-Y	12	12	19.5	0	6	19.8	18.6	0.3	0.2	CC**09T3...	1.2

*Torque: Recommended clamping torque (N-m)
**RE: Standard corner radius

QC12-JSCL2CR-Y-CHP

Screw-on Y-axis turning modular head with 95° approach angle, for positive 80° rhombic inserts, with high pressure coolant capability

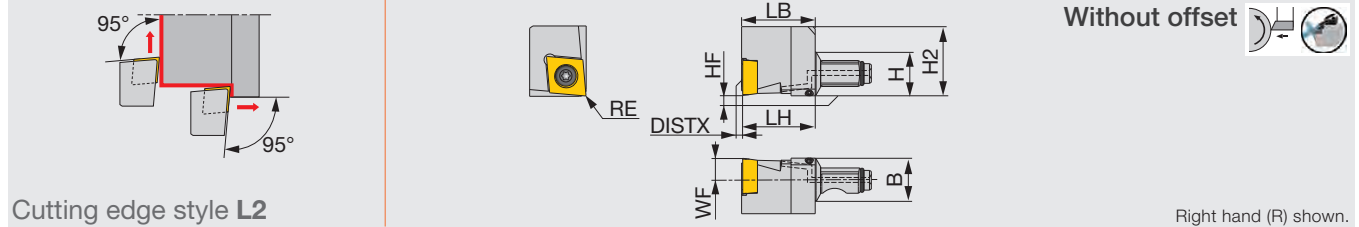

Designation	H	B	LH	HF	WF	LB	H2	DISTX	RE**	Insert	Torque*
QC12-JSCL2CR09-Y-CHP	12	12	19.5	0	6	19.8	18.6	0.3	0.2	CC**09T3...	1.2

Through-coolant head

*Torque: Recommended clamping torque (N-m)

**RE: Standard corner radius

QC12-JSDJ2CR-Y

Screw-on Y-axis turning modular head with 93° approach angle, for positive 55° rhombic inserts

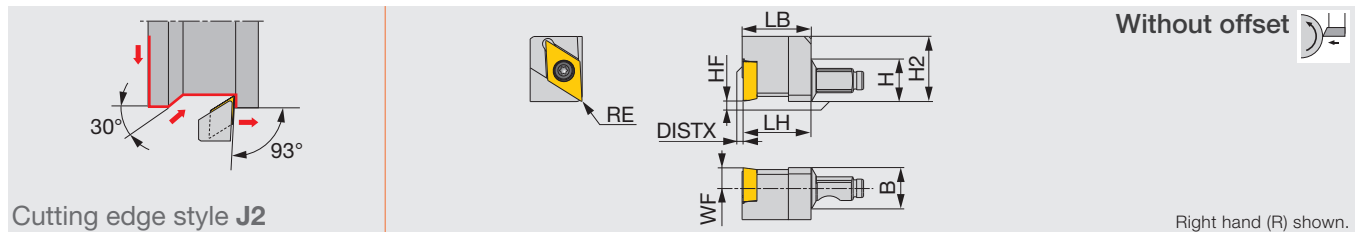

Designation	H	B	LH	HF	WF	LB	H2	DISTX	RE**	Insert	Torque*
QC12-JSDJ2CR11-Y	12	12	19.5	0	6	19.8	18.7	0.3	0.2	DC**11T3...	1.2

*Torque: Recommended clamping torque (N-m)

**RE: Standard corner radius

QC12-JSDJ2CR-Y-CHP

Screw-on Y-axis turning modular head with 93° approach angle, for positive 55° rhombic inserts, with high pressure coolant capability

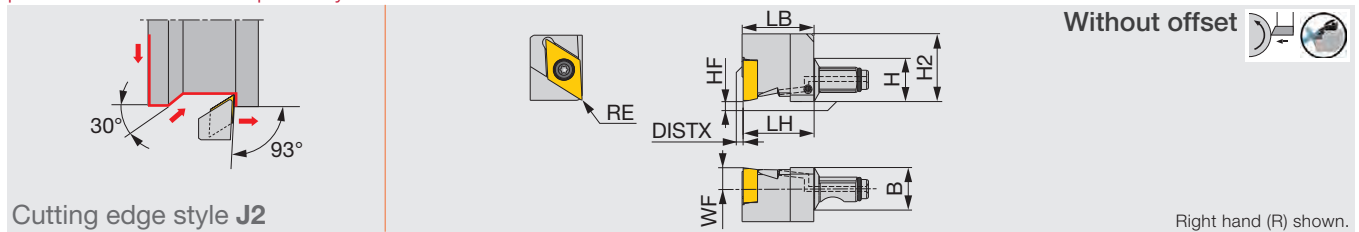

Designation	H	B	LH	HF	WF	LB	H2	DISTX	RE**	Insert	Torque*
QC12-JSDJ2CR11-Y-CHP	12	12	19.5	0	6	19.8	18.7	0.3	0.2	DC**11T3...	1.2

Through-coolant head

*Torque: Recommended clamping torque (N-m)

**RE: Standard corner radius

QC12-JSWL2XR-Y

Screw-on Y-axis turning modular head with 95° approach angle, for WXGU inserts

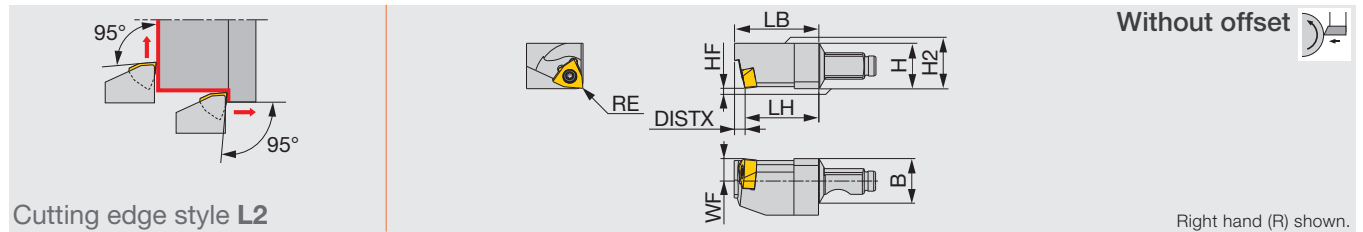

Designation	H	B	LH	HF	WF	LB	H2	DISTX	RE**	Insert	Torque*
QC12-JSWL2XR04-Y	12	12	19.5	0	6	22.3	12	2.8	0.2	WXGU0403**L...	0.9

Use right-hand toolholders (R) with left-hand inserts (L).
 *Torque: Recommended clamping torque (N·m)
 **RE: Standard corner radius

QC12-JSWL2XR-Y-CHP

Screw-on Y-axis turning modular head with 95° approach angle, for WXGU inserts, with high pressure coolant capability

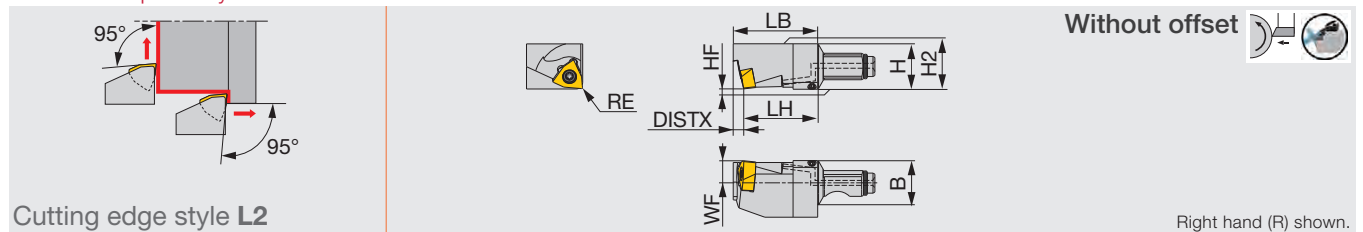

Designation	H	B	LH	HF	WF	LB	H2	DISTX	RE**	Insert	Torque*
QC12-JSWL2XR04-Y-CHP	12	12	19.5	0	6	22.3	12	2.8	0.2	WXGU0403**L...	0.9

Use right-hand toolholders (R) with left-hand inserts (L).
 Through-coolant head
 *Torque: Recommended clamping torque (N·m)
 **RE: Standard corner radius

QC12-JSDJ2XR-Y

Screw-on Y-axis turning modular head with 93° approach angle, for DX*U inserts

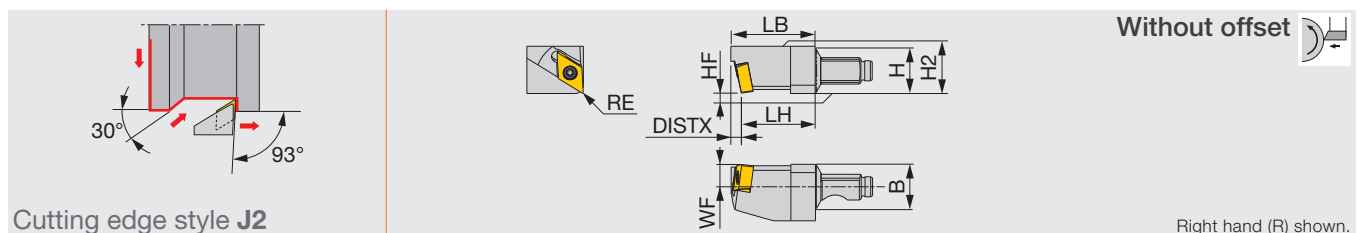

Designation	H	B	LH	HF	WF	LB	H2	DISTX	RE**	Insert	Torque*
QC12-JSDJ2XR07-Y	12	12	19.5	0	6	22.3	12.5	2.8	0.2	DX*U0703**L...	0.9

Use right-hand toolholders (R) with left-hand inserts (L).
 *Torque: Recommended clamping torque (N·m)
 **RE: Standard corner radius

QC12-JSDJ2XR-Y-CHP

Screw-on Y-axis turning modular head with 93° approach angle, for DX*U inserts, with high pressure coolant capability

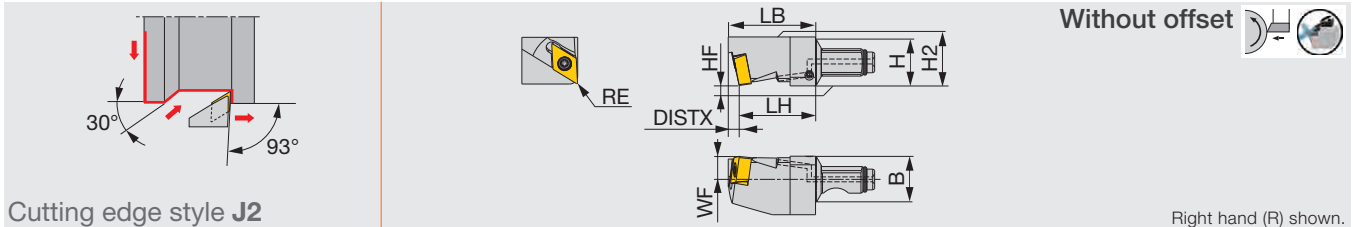

Designation	H	B	LH	HF	WF	LB	H2	DISTX	RE**	Insert	Torque*
QC12-JSDJ2XR07-Y-CHP	12	12	19.5	0	6	22.3	12.5	2.8	0.2	DX*U0703**L...	0.9

Use right-hand toolholders (R) with left-hand inserts (L).
Through-coolant head
*Torque: Recommended clamping torque (N-m)
**RE: Standard corner radius

QC12-STCR-Y

Y-axis turning modular head for external grooving and threading

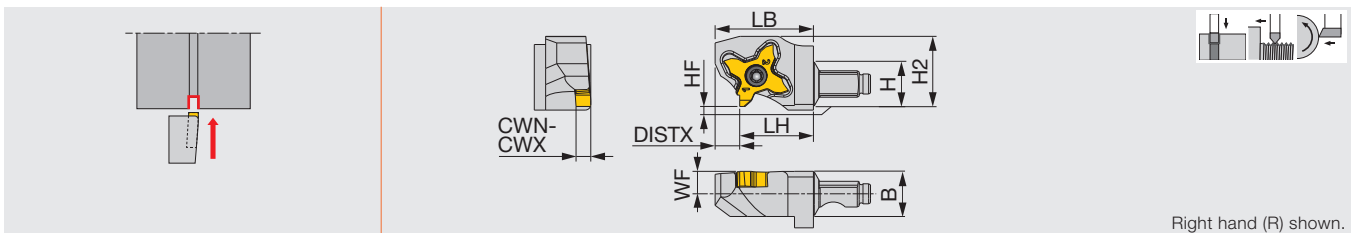

Designation	CWN	CWX	H	B	LH	HF	WF	LB	H2	DISTX	Insert	Torque*
QC12-STCR18-Y	0.33	3	12	12	19.5	0	6	26	18.6	6.5	TC*18R...	1.2

The right hand insert (R) is used for the right hand toolholder (R).
*Torque: Recommended clamping torque (N-m)

QC12-STCR-Y-CHP

Y-axis turning modular head for external grooving and threading, with high pressure coolant capability

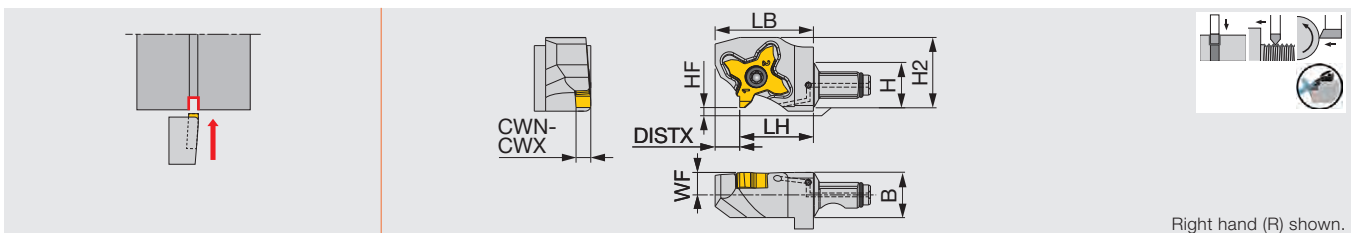

Designation	CWN	CWX	H	B	LH	HF	WF	LB	H2	DISTX	Insert	Torque*
QC12-STCR18-Y-CHP	0.33	3	12	12	19.5	0	6	26	18.6	6.5	TC*18R...	1.2

The right hand insert (R) is used for the right hand toolholder (R).
Through-coolant head
*Torque: Recommended clamping torque (N-m)

Right-hand insert



TC*18R...

QC12-STCL-Y

Y-axis turning modular head for external grooving and threading

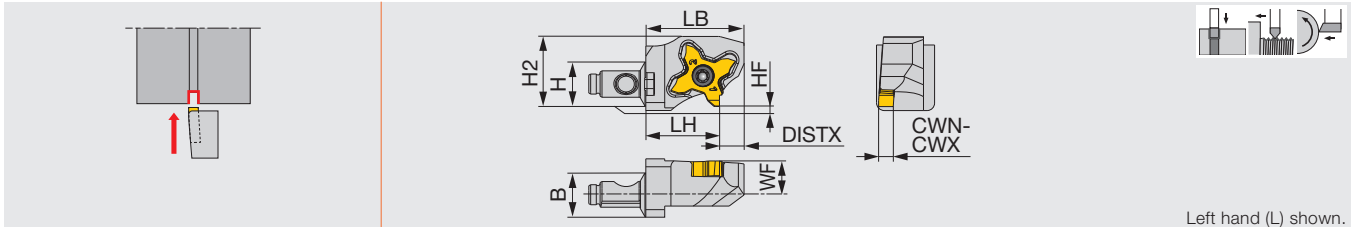

Designation	CWN	CWX	H	B	LH	HF	WF	LB	H2	DISTX	Insert	Torque*
QC12-STCL18-Y	0.33	3	12	12	19.5	0	9	26	18.6	6.5	TC*18L...	1.2

The left hand insert (L) is used for the left hand toolholder (L).
*Torque: Recommended clamping torque (N·m)

QC12-STCL-Y-CHP

Y-axis turning modular head for external grooving and threading, with high pressure coolant capability

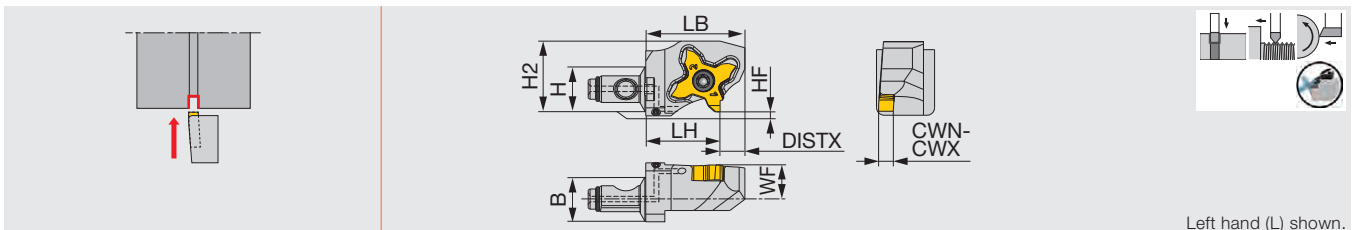

Designation	CWN	CWX	H	B	LH	HF	WF	LB	H2	DISTX	Insert	Torque*
QC12-STCL18-Y-CHP	0.33	3	12	12	19.5	0	9	26	18.6	6.5	TC*18L...	1.2

The left hand insert (L) is used for the left hand toolholder (L).
Through-coolant head
*Torque: Recommended clamping torque (N·m)

Left-hand insert



TC*18L...

QC12-STOPPER

Protective plug for shank

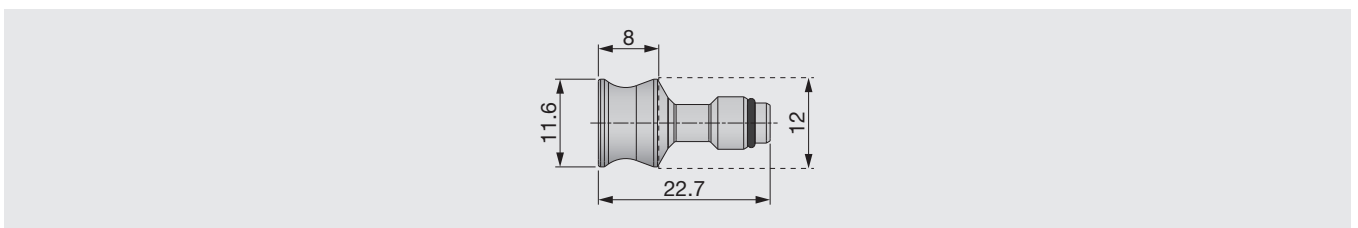

Designation

QC12-STOPPER

SHANKS

QC-1212

Shank for modular heads

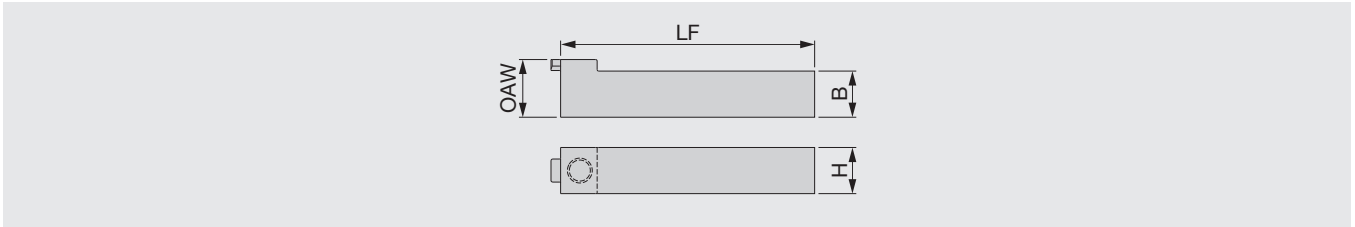

Designation	H	B	LF	OAW	Torque*
QC-1212F	12	12	65	15	3
QC-1212X	12	12	100	15	3

*Torque: Recommended clamping torque (N-m)

QC-1212-CHP

Shank for modular heads, with high pressure coolant capability

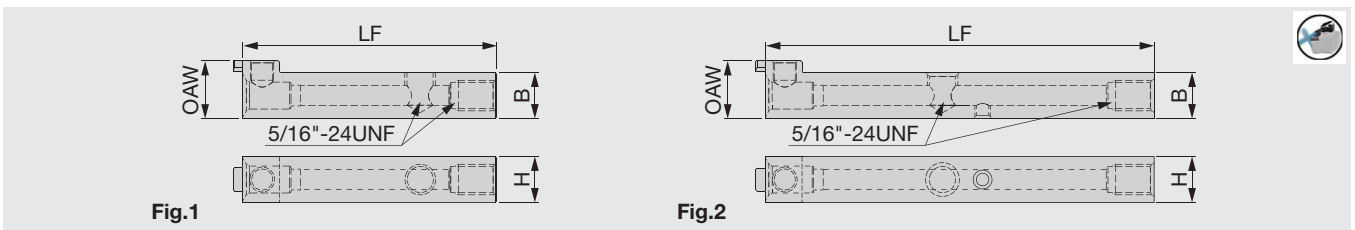

Designation	H	B	LF	OAW	Torque*	Fig.
QC-1212F-CHP	12	12	65	15	3	1
QC-1212X-CHP ⁽¹⁾	12	12	100	15	3	2

(1) Compatible to the direct internal coolant supply system without the use of external coolant hose. Through-coolant shank

*Torque: Recommended clamping torque (N-m)

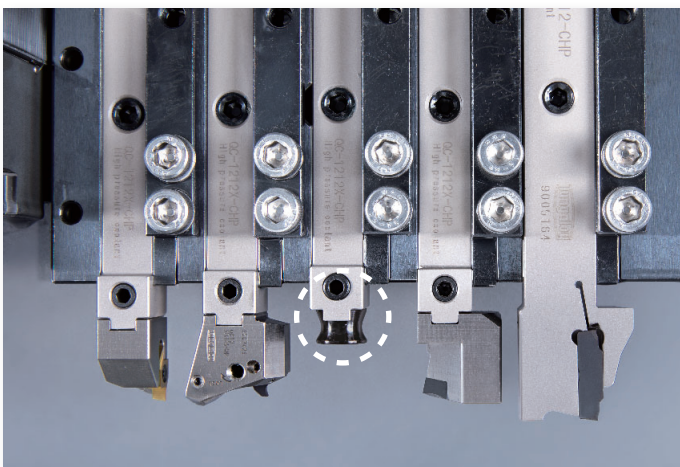

The cutting head located in the feed direction of the Y-axis tool can be removed to make room for machining larger-sized barstock. If this is the case, attach the plug to the shank to protect the coupling surface from chips, as well as prevent coolant leakage during machining.

Milling



- 80 AddDoFeed
- 86 DoFeed
- 94 DoFeedTri
- 100 Tung-Tri
- 104 TungForce-Rec
- 112 DoMultiRec
- 116 TungMeister

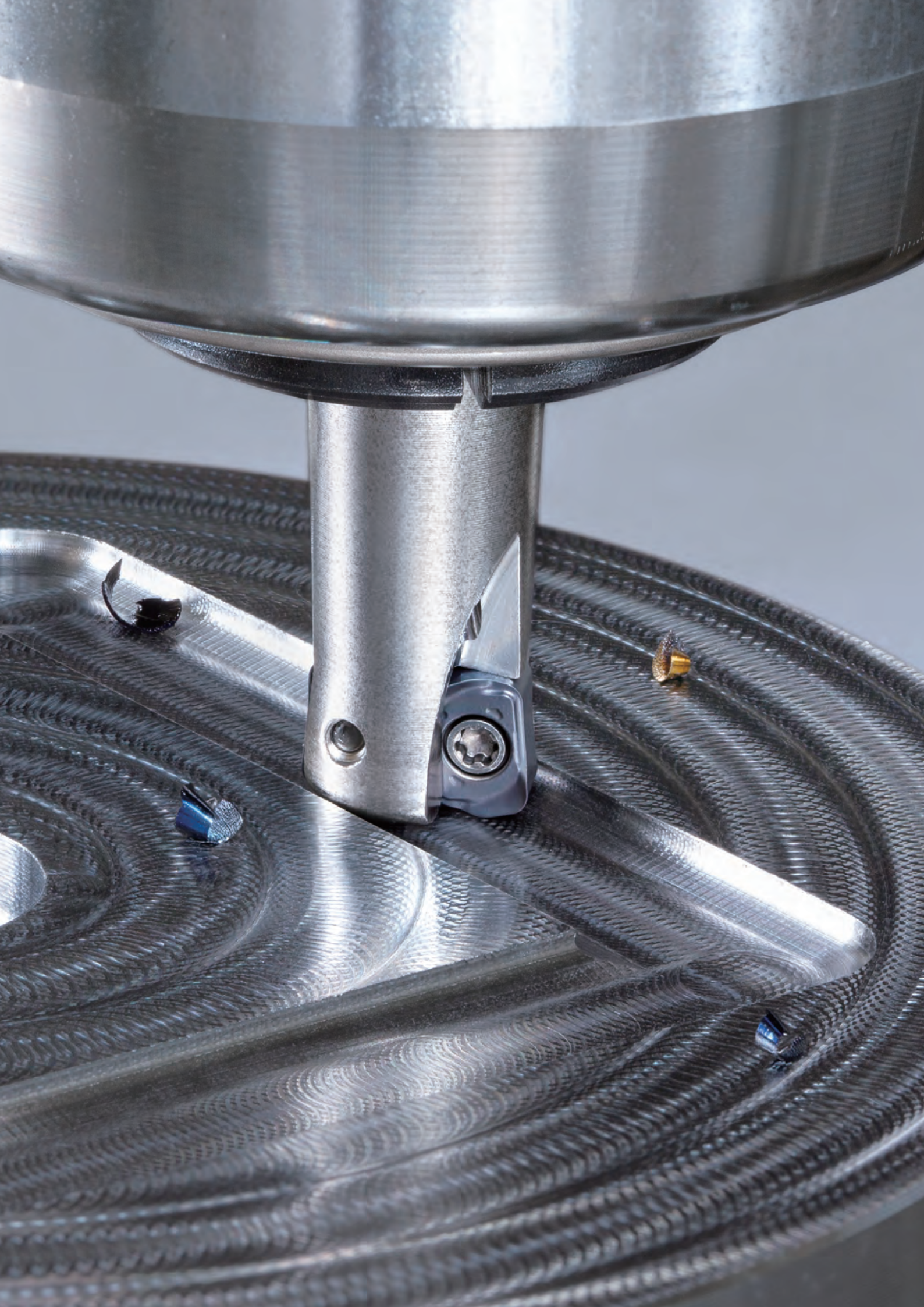

ADD^DFEED

High-feed milling

MAXIMUM SPEED AND EFFICIENCY AT MINIMUM SIZE

ADD more feed and speed in small milling operations for higher productivity

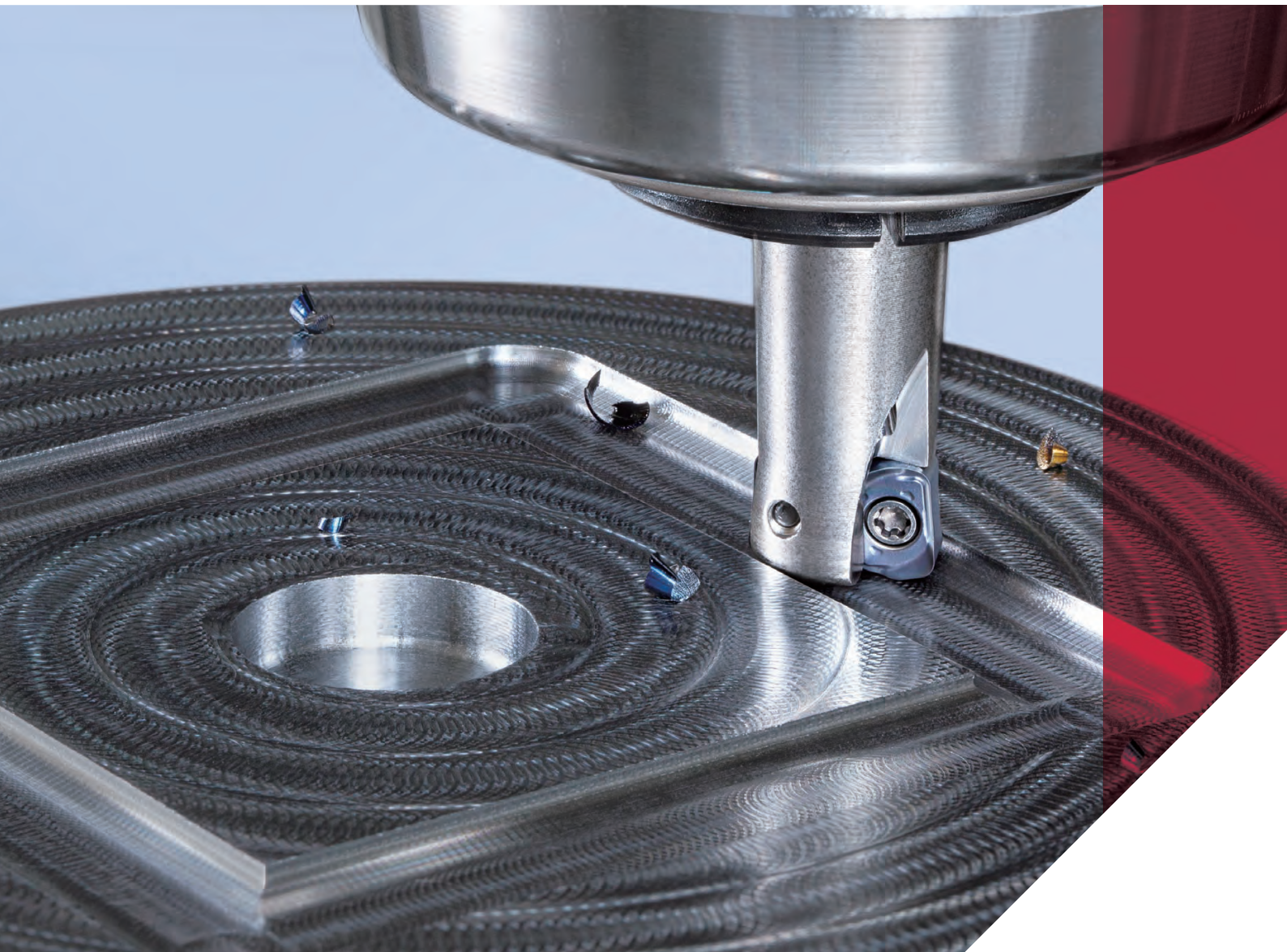



- Small diameter high-feed milling cutter for expanded application coverage, featuring cutter bodies as small as $\varnothing 8$ mm.
- Close pitch cutter design enables high efficiency machining.
- Insert clamping screws are optimized to provide correct clamping force, sustaining high feed rates up to 1.2 mm per tooth.
- Unique insert design with cutting edge inclination provides gradual workpiece engagement for light cutting action, while guiding chips away from the cutting area.
- Ideal for slot milling and pocketing applications.

Lineup

Insert

- LNMU02-MM

Double-sided
 4-edged insert
 APMX = 0.5 mm



Chipbreaker

- **MM type:** Versatile geometry for low cutting forces

Grades

- **AH3225:** Wear and fracture resistant, suited for steel and stainless steel
- **AH130:** Fracture-resistant grade suited for stainless steel and Ti alloys
- **AH8015:** Wear-resistant grade ideal for hardened steel and cast iron

Cutter bodies

Shank type:

- **EXN02R...** (Short type)
 DCX = $\varnothing 8$ - $\varnothing 25$ mm
- **EXN02R**L** (Long type)
 DCX = $\varnothing 8$ - $\varnothing 25$ mm

Modular type:

- **HXN02R...**
 DCX = $\varnothing 8$ - $\varnothing 25$ mm

Scan this QR code
 to find out more
 about this tool!



CUTTER

EXN02

High feed endmill, shank type, for 4-corner double sided inserts

GAMP = +6°, GAMF = +5° ~ +11°

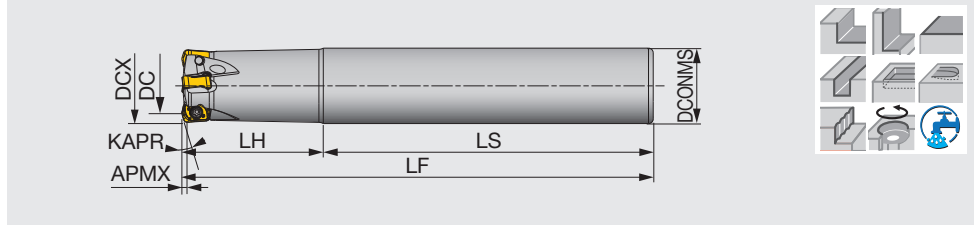

Designation	APMX	DCX	CICT	DC	DCONMS	LF	LH	LS	KAPR	WT (kg)	Air hole	Insert
EXN02R008M08.0-01	0.5	8	1	3.95	8	75	16	59	17°	0.02	With	LNMU02...
EXN02R008M08.0-01L	0.5	8	1	3.95	8	90	31	59	17°	0.03	With	LNMU02...
EXN02R010M10.0-02	0.5	10	2	5.85	10	80	20	60	17°	0.04	With	LNMU02...
EXN02R010M10.0-02L	0.5	10	2	5.85	10	100	40	60	17°	0.05	With	LNMU02...
EXN02R012M12.0-02	0.5	12	2	7.8	12	80	20	60	17°	0.06	With	LNMU02...
EXN02R012M12.0-02L	0.5	12	2	7.8	12	110	50	60	17°	0.08	With	LNMU02...
EXN02R016M16.0-04	0.5	16	4	11.8	16	100	30	70	17°	0.14	With	LNMU02...
EXN02R016M16.0-03L	0.5	16	3	11.8	16	120	50	70	17°	0.17	With	LNMU02...
EXN02R020M20.0-04L	0.5	20	4	15.8	20	160	80	80	17°	0.32	With	LNMU02...
EXN02R020M20.0-05	0.5	20	5	15.8	20	130	50	80	17°	0.27	With	LNMU02...
EXN02R025M25.0-07	0.5	25	7	20.8	25	140	60	80	17°	0.46	With	LNMU02...
EXN02R025M25.0-06L	0.5	25	6	20.8	25	180	100	80	17°	0.57	With	LNMU02...

TUNGFLEX

HXN02

High feed endmill, modular type (TungFlex)

GAMP = +6°, GAMF = +5° ~ +11°

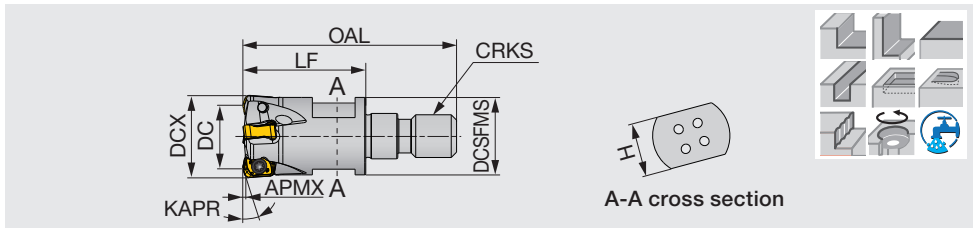

Designation	APMX	DCX	CICT	DC	DCSFMS	OAL	LF	H	KAPR	CRKS	WT (kg)	Air hole	Insert
HXN02R008MM06-01	0.5	8	1	3.95	9.5	33.5	19	7	17°	M6	0.01	With	LNMU02...
HXN02R010MM06-02	0.5	10	2	5.85	9.5	31.5	17	7	17°	M6	0.01	With	LNMU02...
HXN02R012MM06-02	0.5	12	2	7.8	10	31.5	17	7	17°	M6	0.01	With	LNMU02...
HXN02R016MM08-04	0.5	16	4	11.8	14.5	40	23	10	17°	M8	0.03	With	LNMU02...
HXN02R020MM10-05	0.5	20	5	15.8	17.8	49	30	15	17°	M10	0.06	With	LNMU02...
HXN02R025MM12-07	0.5	25	7	20.8	23	52	30	17	17°	M12	0.1	With	LNMU02...

INSERT

LNMU02-MM (for general purpose)

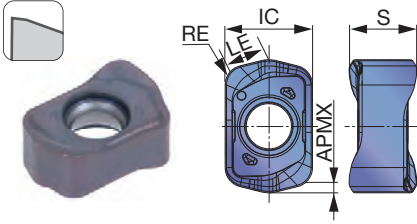

P	Steel		★	☆					
M	Stainless	★	☆						
K	Cast iron		☆	★					
N	Non-ferrous								
S	Superalloy	★		★					
H	Hard materials		☆	★					

★ : First choice
 ☆ : Second choice

Designation	RE	APMX	Coated								LE	IC	S	
			AH130	AH3225	AH8015									
LNMU0202ZER-MM	0.9	0.5	●	●	●							1.79	4	3.1

● : New

STANDARD CUTTING CONDITIONS

ISO	Workpiece materials	Hardness	Priority	Grades	Cutting speed Vc (m/min)	Feed per tooth fz (mm/t)	
P	Carbon steels S45C, S55C, etc. C45, C55, etc.	- 300HB	First choice	AH3225	100 - 300	0.2 - 1.2	
		- 300HB	For wear resistance	AH8015	100 - 300	0.2 - 1.2	
	Alloy steels SCM440, etc. 42CrMo4, etc.	- 300HB	First choice	AH3225	100 - 300	0.2 - 1.2	
		- 300HB	For wear resistance	AH8015	100 - 300	0.2 - 1.2	
	Prehardened steels NAK80, PX5, etc.	30 - 40HRC	First choice	AH8015	100 - 200	0.2 - 0.8	
		30 - 40HRC	For impact resistance	AH3225	100 - 200	0.2 - 0.8	
M	Stainless steels SUS304, SUS316, etc. X5CrNi18-9, X5CrNiMo17-12-3, etc.	- 200HB	First choice	AH130	100 - 150	0.2 - 0.8	
K	Gray cast irons FC250, FC300, etc. 250, 300, etc.	150 - 250HB	First choice	AH8015	100 - 300	0.2 - 1.2	
		150 - 250HB	For impact resistance	AH3225	100 - 300	0.2 - 1.2	
	Ductile cast irons FCD600, etc. 600-3, etc.	150 - 250HB	First choice	AH8015	80 - 200	0.2 - 1.2	
		150 - 250HB	For impact resistance	AH3225	80 - 200	0.2 - 1.2	
S	Titanium alloy Ti-6Al-4V, etc.	- 40HRC	First choice	AH130	30 - 60	0.2 - 0.7	
		- 40HRC	For wear resistance	AH8015	30 - 60	0.2 - 0.7	
	Heat resistant alloy Inconel, Hastelloy, etc.	- 40HRC	First choice	AH8015	20 - 50	0.1 - 0.3	
		- 40HRC	For impact resistance	AH3225	20 - 50	0.1 - 0.3	
H	Hardened steel	SKD61, etc. X40CrMoV5-1, etc.	40 - 50HRC	First choice	AH8015	80 - 150	0.1 - 0.5
			40 - 50HRC	For impact resistance	AH3225	80 - 150	0.1 - 0.5
		SKD11, etc. X153CrMoV12, etc.	50-60HRC	First choice	AH8015	50 - 70	0.1 - 0.3

APPLICATION RANGE

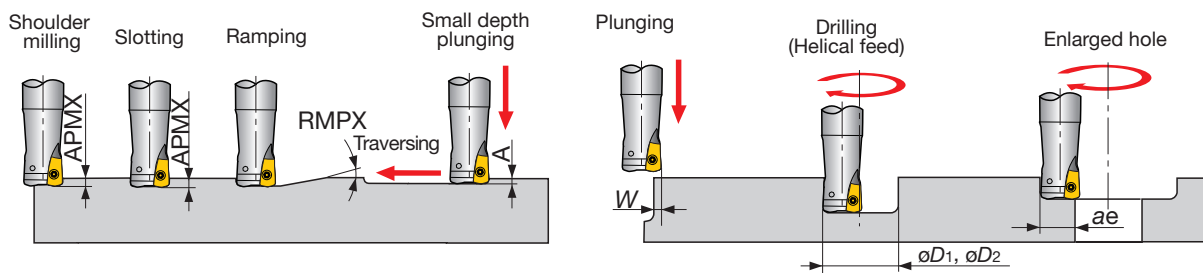

Designation	DCX	Max. depth of cut APMX	Max. ramping angle RMPX	Max. plunging depth A	Max. cutting width in plunging W	Min. machining $\phi D1$	Max. machining $\phi D2$	Max. cutting width in enlarged hole ae
E/HXN02R008...	8	0.5	1.07	0.15	2	10	13.2	5.87
E/HXN02R010...	10	0.5	2.8	0.15	2	13.8	17	7.82
E/HXN02R012...	12	0.5	1.9	0.15	2	17.8	21	9.81
E/HXN02R016...	16	0.5	1.2	0.15	2	25.8	29	13.8
E/HXN02R020...	20	0.5	0.88	0.15	2	33.8	37	17.8
E/HXN02M025...	25	0.5	0.66	0.15	2	43.8	47	22.8

Tool dia.: ϕD_c (mm), Number of revolutions: n (min⁻¹), Feed speed: V_f (mm/min), Max. depth of cut: $a_p = 0.5$ mm, Number of teeth: CICT

$\phi 8$, CICT = 1		$\phi 10$, CICT = 2		$\phi 12$, CICT = 2		$\phi 16$			$\phi 20$			$\phi 25$		
n	V_f	n	V_f	n	V_f	n	V_f		n	V_f		n	V_f	
							CICT = 3	CICT = 4		CICT = 4	CICT = 5		CICT = 6	CICT = 7
7,960	6,370	6,370	10,200	5,310	8,500	3,980	9,560	12,740	3,180	10,180	12,720	2,550	12,240	14,280
$V_c = 200$ m/min, $f_z = 0.8$ mm/t														
7,960	6,370	6,370	10,200	5,310	8,500	3,980	9,560	12,740	3,180	10,180	12,720	2,550	12,240	14,280
$V_c = 200$ m/min, $f_z = 0.8$ mm/t														
5,970	2,990	4,780	4,780	3,980	3,980	2,990	4,490	5,980	2,390	4,780	5,980	1,910	5,730	6,690
$V_c = 150$ m/min, $f_z = 0.5$ mm/t														
4,780	2,390	3,820	3,820	3,190	3,190	2,390	3,590	4,780	1,910	3,820	4,780	1,530	4,590	5,360
$V_c = 120$ m/min, $f_z = 0.5$ mm/t														
7,960	6,370	6,370	10,200	5,310	8,500	3,980	9,560	12,740	3,180	10,180	12,720	2,550	12,240	14,280
$V_c = 200$ m/min, $f_z = 0.8$ mm/t														
5,970	4,780	4,780	7,650	3,980	6,370	2,990	7,180	9,570	2,390	7,650	9,560	1,530	7,350	8,570
$V_c = 150$ m/min, $f_z = 0.8$ mm/t														
1,590	800	1,270	1,270	1,060	1,060	800	1,200	1,600	640	1,280	1,600	510	1,530	1,790
$V_c = 40$ m/min, $f_z = 0.5$ mm/t														
1,190	240	1,000	400	800	320	600	360	480	480	390	480	380	460	540
$V_c = 30$ m/min, $f_z = 0.2$ mm/t														
4,780	1,440	3,820	2,300	3,190	1,920	2,390	2,160	2,870	1,910	2,300	2,870	1,530	2,760	3,220
$V_c = 120$ m/min, $f_z = 0.3$ mm/t														
2,390	480	1,910	770	1,590	640	1,190	720	960	950	760	950	760	920	1,070
$V_c = 60$ m/min, $f_z = 0.2$ mm/t														

TOOL GEOMETRY ON PROGRAMMING

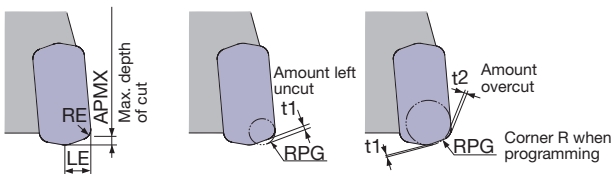

Max. depth of cut APMX (mm)	Corner radius RE (mm)	LE (mm)	Corner R when programming RPG	Amount left uncut t1 (mm)	Amount overcut t2 (mm)
0.5	0.9	2	0.5	0.38	0
0.5	0.9	2	0.8	0.31	0
0.5	0.9	2	1	0.26	0
0.5	0.9	2	1.5	0.14	0.08

*Recommended

DOFEED

High-feed milling

VERSATILE HIGH-FEED MILLING CUTTER SERIES NOW OFFERS SIZE-03 UER INSERTS FOR LOWER APPROACH ANGLE

ADD low approach angles for longer tool life in difficult-to-cut materials





- Two insert styles: UER and ZER are interchangeable on the same cutter body.
- Thanks to small approach angle, UER inserts generate thin chips, reducing cutting load on the edge for prolonged tool life.
- Economical double-sided insert with four total cutting edges.
- UER inserts provide stability in long overhang milling.
- A wide range of insert and cutter body lineup for extensive application ranges.

Lineup

Inserts

- **LNMU0303UER-MJ / ML**
 APMX = 0.9 mm

Chipbreakers

- **MJ type:** Versatile geometry for good chip evacuation
- **ML type:** For low cutting forces

Grades

- **AH3225:** Wear and fracture resistant, suited for steel and stainless steel
- **AH130:** Fracture-resistant grade suited for stainless steel and Ti alloys
- **AH8015:** Wear-resistant grade ideal for hardened steel and cast iron

Cutter bodies

Shank type:

- **EXN03...**
 (Short type, with center through coolant hole)
 DCX = $\varnothing 16$ - $\varnothing 35$ mm
- **EXN03**-L**
 (Long type, with center through coolant hole)
 DCX = $\varnothing 16$ - $\varnothing 35$ mm

- EXN03**-C

(Short type, with coolant directly to the tool tips)
 DCX = $\varnothing 16$ - $\varnothing 40$ mm

- EXN03**-L-C

(Long type, with coolant directly to the tool tips)
 DCX = $\varnothing 16$ - $\varnothing 40$ mm

- EXN03**-N

(Short type, without coolant hole)
 DCX = $\varnothing 16$ - $\varnothing 32$ mm

Bore type:

- TXN03...

DCX = $\varnothing 40$ - $\varnothing 50$ mm

Modular type:

- HXN03... (with center through coolant hole)

DCX = $\varnothing 16$ - $\varnothing 32$ mm

- HXN03**-C (with coolant directly to the tool tips)

DCX = $\varnothing 16$ - $\varnothing 40$ mm

Scan this QR code
 to find out more
 about this tool!



CUTTER

TXN03

High feed mill, for 4-corner double sided inserts

GAMP = +6°, GAMF = +12° ~ 13°

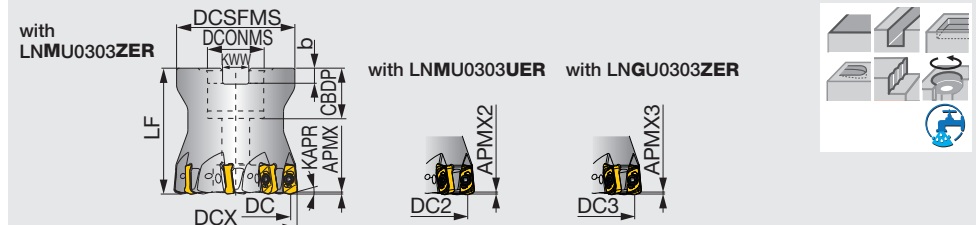

Designation	APMX	APMX2	APMX3	DCX	CICT	DC	DC2	DC3	DCSFMS	DCONMS	CBDP	LF	b	KWW	KAPR	KAPR2*	KAPR3*	WT(kg)	Air hole	Insert
TXN03R040M16.0E05	1	0.9	1	40	5	33.6	32.8	33.7	35	16	18	40	5.6	8.4	17°	12°	17°	0.2	With LN*U03...	
TXN03R040M16.0E06	1	0.9	1	40	6	33.6	32.8	33.7	35	16	18	40	5.6	8.4	17°	12°	17°	0.2	With LN*U03...	
TXN03R050M22.0E05	1	0.9	1	50	5	43.6	42.8	43.7	47	22	20	50	6.3	10.4	17°	12°	17°	0.5	With LN*U03...	
TXN03R050M22.0E08	1	0.9	1	50	8	43.6	42.8	43.7	47	22	20	50	6.3	10.4	17°	12°	17°	0.5	With LN*U03...	
TXN03R050M22.2-08	1	0.9	1	50	8	43.6	42.8	43.7	47	22.225	20	50	5	8	17°	12°	17°	0.5	With LN*U03...	

*KAPR2 : with LNMU0303UER
*KAPR3 : with LNGU0303ZER

EXN03

High feed endmill, shank type, with center through coolant hole, for 4-corner double sided inserts

GAMP = +6°, GAMF = +5° ~ +11°

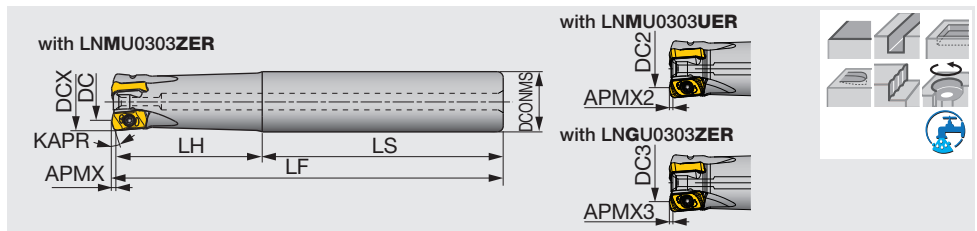

Designation	APMX	APMX2	APMX3	DCX	CICT	DC	DC2	DC3	DCONMS	LF	LH	LS	KAPR	KAPR2*	KAPR3*	WT(kg)	Air hole	Insert
EXN03R016M16.0-02	1	0.9	1	16	2	9.6	8.8	9.8	16	100	30	70	15°	10°	15°	0.2	With LN*U03...	
EXN03R016M16.0-02L	1	0.9	1	16	2	9.6	8.8	9.8	16	150	50	100	15°	10°	15°	0.2	With LN*U03...	
EXN03R018M16.0-02	1	0.9	1	18	2	11.5	10.7	11.7	16	100	30	70	17°	12°	17°	0.2	With LN*U03...	
EXN03R018M16.0-02L	1	0.9	1	18	2	11.5	10.7	11.7	16	150	25	125	17°	12°	17°	0.2	With LN*U03...	
EXN03R020M20.0-03	1	0.9	1	20	3	13.5	12.7	13.6	20	130	50	80	17°	12°	17°	0.3	With LN*U03...	
EXN03R020M20.0-03L	1	0.9	1	20	3	13.5	12.7	13.6	20	160	80	80	17°	12°	17°	0.3	With LN*U03...	
EXN03R020M20.0-04	1	0.9	1	20	4	13.5	12.7	13.6	20	130	50	80	17°	12°	17°	0.3	With LN*U03...	
EXN03R022M20.0-03	1	0.9	1	22	3	15.5	14.7	15.6	20	130	50	80	17°	12°	17°	0.3	With LN*U03...	
EXN03R022M20.0-03L	1	0.9	1	22	3	15.5	14.7	15.6	20	160	30	130	17°	12°	17°	0.4	With LN*U03...	
EXN03R022M20.0-04	1	0.9	1	22	4	15.5	14.7	15.6	20	130	50	80	17°	12°	17°	0.3	With LN*U03...	
EXN03R025M25.0-04	1	0.9	1	25	4	18.5	17.7	18.6	25	140	60	80	17°	12°	17°	0.5	With LN*U03...	
EXN03R025M25.0-04L	1	0.9	1	25	4	18.5	17.7	18.6	25	180	100	80	17°	12°	17°	0.6	With LN*U03...	
EXN03R025M25.0-05	1	0.9	1	25	5	18.5	17.7	18.6	25	140	60	80	17°	12°	17°	0.5	With LN*U03...	
EXN03R028M25.0-04	1	0.9	1	28	4	21.5	20.7	21.6	25	140	60	80	17°	12°	17°	0.5	With LN*U03...	
EXN03R028M25.0-04L	1	0.9	1	28	4	21.5	20.7	21.6	25	180	35	145	17°	12°	17°	0.7	With LN*U03...	
EXN03R028M25.0-05	1	0.9	1	28	5	21.5	20.7	21.6	25	140	60	80	17°	12°	17°	0.5	With LN*U03...	
EXN03R030M32.0-04	1	0.9	1	30	4	23.5	22.7	23.6	32	150	70	80	17°	12°	17°	0.8	With LN*U03...	
EXN03R030M32.0-04L	1	0.9	1	30	4	23.5	22.7	23.6	32	200	120	80	17°	12°	17°	0.9	With LN*U03...	
EXN03R030M32.0-05	1	0.9	1	30	5	23.5	22.7	23.6	32	150	70	80	17°	12°	17°	0.8	With LN*U03...	
EXN03R032M32.0-05	1	0.9	1	32	5	25.5	24.7	25.6	32	150	70	80	17°	12°	17°	0.8	With LN*U03...	
EXN03R032M32.0-05L	1	0.9	1	32	5	25.5	24.7	25.6	32	200	120	80	17°	12°	17°	1.1	With LN*U03...	
EXN03R032M32.0-06	1	0.9	1	32	6	25.5	24.7	25.6	32	150	70	80	17°	12°	17°	0.9	With LN*U03...	
EXN03R035M32.0-05	1	0.9	1	35	5	28.5	27.7	28.6	32	150	35	115	17°	12°	17°	0.9	With LN*U03...	
EXN03R035M32.0-05L	1	0.9	1	35	5	28.5	27.7	28.6	32	200	35	165	17°	12°	17°	1.2	With LN*U03...	
EXN03R035M32.0-06	1	0.9	1	35	6	28.5	27.7	28.6	32	150	35	115	17°	12°	17°	0.9	With LN*U03...	

*KAPR2 : with LNMU0303UER
*KAPR3 : with LNGU0303ZER

EXN03-C

High feed endmill, shank type, with coolant directly to the tool tips, for 4-corner double sided inserts

GAMP = +6°, GAMF = +5° ~ +11°

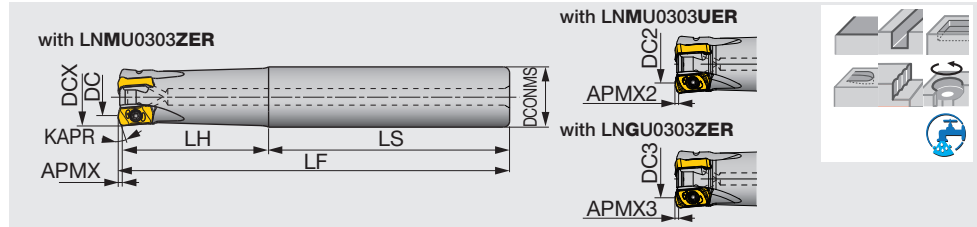

Designation	APMX	APMX2	APMX3	DCX	CICT	DC	DC2	DC3	DCONMS	LF	LH	LS	KAPR	KAPR2*	KAPR3*	WT(kg)	Air hole	Insert
EXN03R016M16.0-02-C	1	0.9	1	16	2	9.6	8.8	9.8	16	100	30	70	15°	10°	15°	0.2	With LN*U03...	
EXN03R016M16.0-02L-C	1	0.9	1	16	2	9.6	8.8	9.8	16	150	50	100	15°	10°	15°	0.2	With LN*U03...	
EXN03R020M20.0-03-C	1	0.9	1	20	3	13.5	12.7	13.6	20	130	50	80	17°	12°	17°	0.3	With LN*U03...	
EXN03R020M20.0-03L-C	1	0.9	1	20	3	13.5	12.7	13.6	20	160	80	80	17°	12°	17°	0.3	With LN*U03...	
EXN03R020M20.0-04-C	1	0.9	1	20	4	13.5	12.7	13.6	20	130	50	80	17°	12°	17°	0.3	With LN*U03...	
EXN03R025M25.0-04-C	1	0.9	1	25	4	18.5	17.7	18.6	25	140	60	80	17°	12°	17°	0.5	With LN*U03...	
EXN03R025M25.0-04L-C	1	0.9	1	25	4	18.5	17.7	18.6	25	180	100	80	17°	12°	17°	0.6	With LN*U03...	
EXN03R025M25.0-05-C	1	0.9	1	25	5	18.5	17.7	18.6	25	140	60	80	17°	12°	17°	0.5	With LN*U03...	
EXN03R032M32.0-05-C	1	0.9	1	32	5	25.5	24.7	25.6	32	150	70	80	17°	12°	17°	0.8	With LN*U03...	
EXN03R032M32.0-05L-C	1	0.9	1	32	5	25.5	24.7	25.6	32	200	120	80	17°	12°	17°	1.1	With LN*U03...	
EXN03R032M32.0-06-C	1	0.9	1	32	6	25.5	24.7	25.6	32	150	70	80	17°	12°	17°	0.8	With LN*U03...	
EXN03R040M32.0-06-C	1	0.9	1	40	6	33.6	32.8	33.7	32	150	45	105	17°	12°	17°	1	With LN*U03...	
EXN03R040M32.0-06L-C	1	0.9	1	40	6	33.6	32.8	33.7	32	220	45	175	17°	12°	17°	1.4	With LN*U03...	

*KAPR2 : with LNMU0303UER

*KAPR3 : with Lngu0303ZER

EXN03-N

High feed endmill, shank type, without coolant hole, for 4-corner double sided inserts

GAMP = +6°, GAMF = +5° ~ +11°

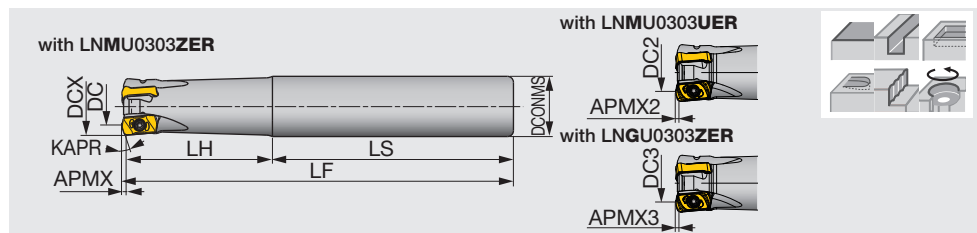

Designation	APMX	APMX2	APMX3	DCX	CICT	DC	DC2	DC3	DCONMS	LF	LH	LS	KAPR	KAPR2*	KAPR3*	WT(kg)	Air hole	Insert
EXN03R016M16.0-02N	1	0.9	1	16	2	9.6	8.8	9.8	16	100	30	70	15°	10°	15°	0.2	Without LN*U03...	
EXN03R020M20.0-03N	1	0.9	1	20	3	13.5	12.7	13.6	20	130	50	80	17°	12°	17°	0.3	Without LN*U03...	
EXN03R025M25.0-04N	1	0.9	1	25	4	18.5	17.7	18.6	25	140	60	80	17°	12°	17°	0.5	Without LN*U03...	
EXN03R032M32.0-05N	1	0.9	1	32	5	25.5	24.7	25.6	32	150	70	80	17°	12°	17°	0.8	Without LN*U03...	

*KAPR2 : with LNMU0303UER

*KAPR3 : with Lngu0303ZER

HXN03

High feed endmill, modular type, with center through coolant hole (TungFlex)

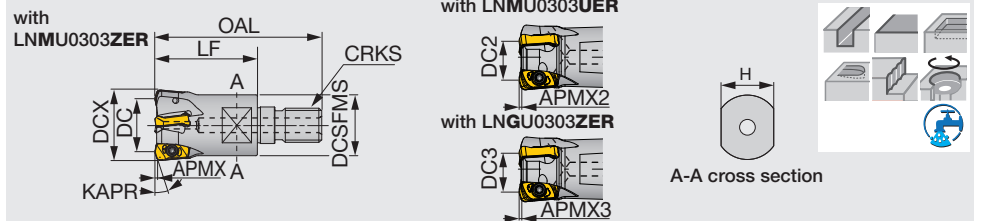

Designation	APMX	APMX2	APMX3	DCX	CICT	DC	DC2	DC3	OAL	LF	H	DCSFMS	KAPR	KAPR2*	KAPR3*	CRKS	WT(kg)	Air hole	Insert
HXN03R016MM08-02	1	0.9	1	16	2	9.6	8.8	9.8	42	25	10	12.8	15°	10°	15°	M8	0.03	With LN*U03...	
HXN03R018MM08-02	1	0.9	1	18	2	11.5	10.7	11.7	42	25	10	14.5	17°	12°	17°	M8	0.04	With LN*U03...	
HXN03R020MM10-03	1	0.9	1	20	3	13.5	12.7	13.6	49	30	15	17.8	17°	12°	17°	M10	0.06	With LN*U03...	
HXN03R020MM10-04	1	0.9	1	20	4	13.5	12.7	13.6	49	30	15	17.8	17°	12°	17°	M10	0.06	With LN*U03...	
HXN03R022MM10-03	1	0.9	1	22	3	15.5	14.7	15.6	49	30	15	17.8	17°	12°	17°	M10	0.06	With LN*U03...	
HXN03R022MM10-04	1	0.9	1	22	4	15.5	14.7	15.6	49	30	15	17.8	17°	12°	17°	M10	0.07	With LN*U03...	
HXN03R025MM12-04	1	0.9	1	25	4	18.5	17.7	18.6	57	35	17	20.8	17°	12°	17°	M12	0.1	With LN*U03...	
HXN03R025MM12-05	1	0.9	1	25	5	18.5	17.7	18.6	57	35	17	20.8	17°	12°	17°	M12	0.11	With LN*U03...	
HXN03R028MM12-04	1	0.9	1	28	4	21.5	20.7	21.6	57	35	17	23	17°	12°	17°	M12	0.12	With LN*U03...	
HXN03R028MM12-05	1	0.9	1	28	5	21.5	20.7	21.6	57	35	17	23	17°	12°	17°	M12	0.12	With LN*U03...	
HXN03R030MM16-04	1	0.9	1	30	4	23.5	22.7	23.6	63	40	22	28.8	17°	12°	17°	M16	0.19	With LN*U03...	
HXN03R030MM16-05	1	0.9	1	30	5	23.5	22.7	23.6	63	40	22	28.8	17°	12°	17°	M16	0.2	With LN*U03...	
HXN03R032MM16-05	1	0.9	1	32	5	25.5	24.7	25.6	63	40	22	28.8	17°	12°	17°	M16	0.2	With LN*U03...	
HXN03R032MM16-06	1	0.9	1	32	6	25.5	24.7	25.6	63	40	22	28.8	17°	12°	17°	M16	0.21	With LN*U03...	

*KAPR2 : with LNMU0303UER
*KAPR3 : with LNGU0303ZER

HXN03-C

High feed endmill, modular type, with coolant directly to the tool tips (TungFlex)

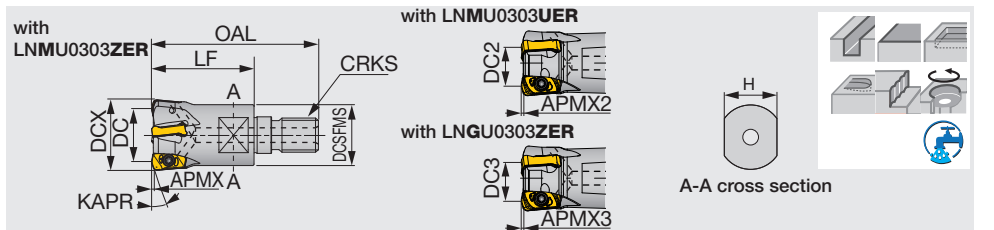

Designation	APMX	APMX2	APMX3	DCX	CICT	DC	DC2	DC3	OAL	LF	H	DCSFMS	KAPR	KAPR2*	KAPR3*	CRKS	WT(kg)	Air hole	Insert
HXN03R016MM08-02-C	1	0.9	1	16	2	9.6	8.8	9.8	42	25	10	12.8	15°	10°	15°	M8	0.03	With LN*U03...	
HXN03R020MM10-03-C	1	0.9	1	20	3	13.5	12.7	13.6	49	30	15	17.8	17°	12°	17°	M10	0.06	With LN*U03...	
HXN03R020MM10-04-C	1	0.9	1	20	4	13.5	12.7	13.6	49	30	15	17.8	17°	12°	17°	M10	0.06	With LN*U03...	
HXN03R025MM12-04-C	1	0.9	1	25	4	18.5	17.7	18.6	57	35	17	20.8	17°	12°	17°	M12	0.1	With LN*U03...	
HXN03R025MM12-05-C	1	0.9	1	25	5	18.5	17.7	18.6	57	35	17	20.8	17°	12°	17°	M12	0.1	With LN*U03...	
HXN03R032MM16-05-C	1	0.9	1	32	5	25.5	24.7	25.6	63	40	22	28.8	17°	12°	17°	M16	0.2	With LN*U03...	
HXN03R032MM16-06-C	1	0.9	1	32	6	25.5	24.7	25.6	63	40	22	28.8	17°	12°	17°	M16	0.2	With LN*U03...	
HXN03R040MM16-06-C	1	0.9	1	40	6	33.6	32.8	33.7	63	40	22	28.8	17°	12°	17°	M16	0.27	With LN*U03...	

*KAPR2 : with LNMU0303UER
*KAPR3 : with LNGU0303ZER

INSERT

LNMU03ZER-MJ (for general purpose)

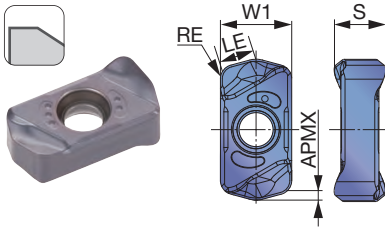

LNMU03ZER-ML (for low cutting force)

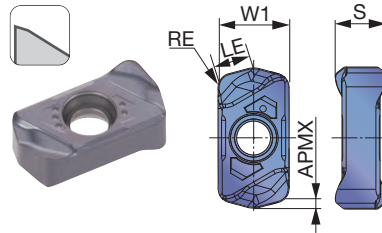

LNMU03ZER-MS (for stainless steel)

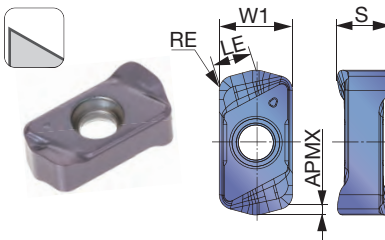

LNGU03ZER-MH (Robust cutting edges)

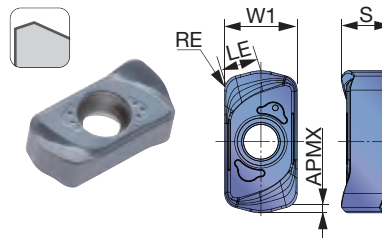

LNMU03UER-MJ (for general purpose, low approach angle)

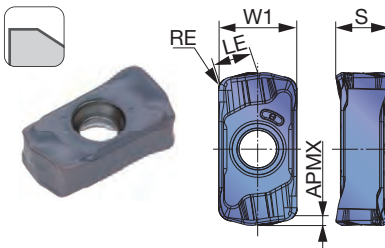

LNMU03UER-ML (for low cutting force, low approach angle)

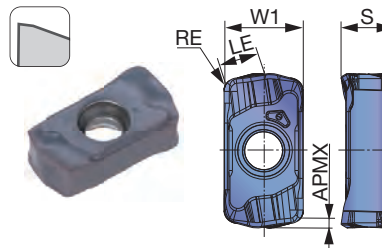

P Steel	★	☆					
M Stainless	★	☆	☆				
K Cast iron		☆	☆	★			
N Non-ferrous							
S Titanium	★	☆					
S Inconel				☆	★		
H Hard materials				☆	★	☆	

★ : First choice
☆ : Second choice

Designation	RE	APMX	Coated						LE	W1	S
			AH130	AH3225	AH3035	AH725	AH8015	AH8005			
LNMU0303ZER-MJ	1.2	1	●	●	●	●	●		3.2	6	4.3
LNMU0303ZER-ML	1.2	1	●	●	●	●	●		3.2	6	4.3
LNMU0303ZER-MS	1.2	1	●	●					3.2	6	4.3
LNGU0303ZER-MH	1.2	1					●	●	3.2	6	4.3
LNMU0303UER-MJ	1	0.9	●	●			●		3.1	6	4.1
LNMU0303UER-ML	1	0.9	●	●			●		3.1	6	4.1

● : New product
● : Line-up

STANDARD CUTTING CONDITIONS UER TYPE

ISO	Workpiece material	Hardness	Priority	Grade	Chip-breaker	Cutting speed Vc (m/min)	Feed per tooth: fz (mm/t)			ø16, CICT = 2		ø18, CICT = 2		ø20		
							Tool dia.: DCX (mm)			n	Vf	n	Vf	n	Vf	
							ø16 ~ ø22	ø25 ~ ø50	Plunging						CICT=3	CICT=4
P	Carbon steels S45C, C45, S55C, C55, etc.	- 300HB	First choice Low resistance	AH3225	MJ ML	100 - 300	0.5 - 1.2	0.5 - 1.5	0.1	3,980	7,960	3,540	7,080	3,180	9,540	12,720
	Alloy steels SCM440, 42CrMo4, etc.	- 300HB	First choice Low resistance	AH3225	MJ ML	100 - 300	0.5 - 1.2	0.5 - 1.5	0.1	3,980	7,960	3,540	7,080	3,180	9,540	12,720
M	Prehardened steels NAK80, PX5, etc.	30 - 40HRC	First choice for impact resistance	AH8015 AH3225	MJ MJ	100 - 200	0.5 - 1	0.5 - 1	0.1	2,980	4,770	2,650	4,240	2,390	5,740	7,650
	Austenitic stainless steels SUS304, X5CrNi18-9, etc.	- 200HB	First choice for impact resistance	AH130	ML MJ	80 - 150	0.3 - 1	0.3 - 1	0.1	2,390	2,870	2,120	2,550	1,910	3,440	4,590
K	Precipitation hardening stainless steels SUS630, X5CrNiCuNb16-4, etc.	28HRC - 40HRC -	First choice for impact resistance	AH130	ML MJ	80 - 150	0.3 - 0.8	0.3 - 0.8	0.1	2,390	2,390	2,120	2,120	1,910	2,870	3,820
	Gray cast irons FC250, GG25, 250, etc.	150 - 250HB	First choice for impact resistance	AH8015 AH3225	MJ MJ	100 - 300	0.5 - 1.2	0.5 - 1.5	0.1	3,980	7,960	3,540	7,080	3,180	9,540	12,720
S	Ductile cast irons FCD400, etc.	150 - 250HB	First choice for impact resistance	AH8015 AH3225	MJ MJ	80 - 200	0.5 - 1.2	0.5 - 1.5	0.1	2,980	5,960	2,650	5,300	2,390	7,170	9,560
	Titanium alloy Ti-6Al-4V, etc.	- 40HRC	First choice for wear resistance	AH130 AH8015	MJ MJ	30 - 60	0.3 - 0.8	0.3 - 0.8	0.08	800	960	710	860	640	1,160	1,540
H	Heat-resistant alloy Inconel, Hasteloy, etc.	- 40HRC	First choice for impact resistance	AH8015	ML MJ	20 - 50	0.2 - 0.5	0.2 - 0.5	0.05	600	360	530	320	480	440	580
	Hot mold steel SKD61, X40CrMoV5-1, etc.	40-50HRC	First choice for impact resistance	AH8015 AH3225	MJ MJ	80 - 150	0.1 - 0.5	0.1 - 0.5	0.05	2,390	1,440	2,120	1,280	1,910	1,720	2,300
S	Hot mold steel of D.T.C materials DAC**, DH**, DIEVER, etc.	40-50HRC	First choice for impact resistance	AH8015 AH3225	MJ MJ	50 - 100	0.1 - 0.5	0.1 - 0.5	0.05	1,590	960	1,410	850	1,270	1,150	1,530
	Cold mold steels SKD11, X153CrMoV12, etc.	50-60HRC	First choice	AH8005	MJ	50 - 70	0.1 - 0.3	0.1 - 0.3	0.03	1,190	480	1,060	430	950	570	760

- When chips stay in the cutting zone during slotting or pocketing, use air blast to remove chips from the work area

- Tool overhang length must be as short as possible to avoid chatter. When the tool overhang length is long, decrease the number of revolutions and feed

TOOL GEOMETRY ON PROGRAMMING

When programming for CAM, the tool should be considered as a radius cutter. Usually, the corner radius should be set as R = 1.5 mm. If a larger radius is used, overcutting will occur. The following table shows the amount left uncut (t1) and overcut (t2).

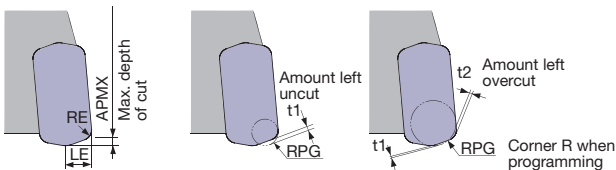

LNMU0303UER...

Max. depth of cut APMX (mm)	Corner radius RE (mm)	LE (mm)	Corner R when programming RPG	Amount left uncut t1 (mm)	Amount left overcut t2 (mm)
0.9	1	3.5	1	0.48	-
0.9	1	3.5	1.5	0.39	-
0.9	1	3.5	2	0.3	0.12
0.9	1	3.5	2.5	0.21	0.31

Each value in table is calculated theoretically at the maximum condition.

*Recommended

Tool dia.: DCX (mm), Number of revolutions: n (min^{-1}), Feed speed: V_f (mm/min), Max. depth of cut: $ap = 0.5$ mm

ø22			ø25			ø28			ø30			ø32			ø35			ø40			ø50		
n	V_f		n	V_f		n	V_f		n	V_f		n	V_f		n	V_f		n	V_f		n	V_f	
	CICT=3	CICT=4		CICT=4	CICT=5		CICT=4	CICT=5		CICT=4	CICT=5		CICT=5	CICT=6		CICT=5	CICT=6		CICT=5	CICT=6		CICT=5	CICT=8
2,890	8,670	11,560	2,550	10,200	12,750	2,270	9,080	11,350	2,120	8,480	10,600	1,990	9,950	11,940	1,820	9,100	10,920	1,590	7,950	9,540	1,270	6,350	10,160
Vc = 200 m/min, fz = 1 mm/t																							
2,890	8,670	11,560	2,550	10,200	12,750	2,270	9,080	11,350	2,120	8,480	10,600	1,990	9,950	11,940	1,820	9,100	10,920	1,590	7,950	9,540	1,270	6,350	10,160
Vc = 200 m/min, fz = 1 mm/t																							
2,170	5,210	6,950	1,910	6,120	7,640	1,710	5,480	6,840	1,590	5,090	6,360	1,490	5,960	7,160	1,360	5,440	6,530	1,190	4,760	5,720	950	3,800	6,080
Vc = 150 m/min, fz = 0.8 mm/t																							
1,740	3,140	4,180	1,530	3,680	4,590	1,360	3,270	4,080	1,270	3,050	3,810	1,190	3,570	4,290	1,090	3,270	3,930	950	2,850	3,420	760	2,280	3,650
Vc = 120 m/min, fz = 0.6 mm/t																							
1,740	2,610	3,480	1,530	3,060	3,830	1,360	2,720	3,400	1,270	2,540	3,180	1,190	2,980	3,570	1,090	2,730	3,270	950	2,380	2,850	760	1,900	3,040
Vc = 120 m/min, fz = 0.5 mm/t																							
1,450	1,740	2,320	1,270	2,040	2,540	1,140	1,830	2,280	1,060	1,700	2,120	990	1,980	2,380	910	1,820	2,190	800	1,600	1,920	640	1,280	2,050
Vc = 100 m/min, fz = 0.4 mm/t																							
2,890	8,670	11,560	2,550	10,200	12,750	2,270	9,080	11,350	2,120	8,480	10,600	1,990	9,950	11,940	1,820	9,100	10,920	1,590	7,950	9,540	1,270	6,350	10,160
Vc = 200 m/min, fz = 1 mm/t																							
2,170	6,510	8,680	1,910	7,640	9,550	1,710	6,840	8,550	1,590	6,360	7,950	1,490	7,450	8,940	1,360	6,800	8,160	1,190	5,950	7,140	950	4,750	7,600
Vc = 150 m/min, fz = 1 mm/t																							
580	1,050	1,400	510	1,230	1,530	450	1,080	1,350	420	1,010	1,260	400	1,200	1,440	360	1,080	1,300	320	960	1,160	250	750	1,200
Vc = 40 m/min, fz = 0.6 mm/t																							
430	390	520	380	460	570	340	410	510	320	390	480	300	450	540	270	410	490	240	360	440	190	290	460
Vc = 30 m/min, fz = 0.3 mm/t																							
1,740	1,570	2,090	1,530	1,840	2,300	1,360	1,640	2,040	1,270	1,530	1,910	1,190	1,790	2,150	1,090	1,640	1,970	950	1,430	1,710	760	1,140	1,830
Vc = 120 m/min, fz = 0.3 mm/t																							
1,160	1,050	1,400	1,020	1,230	1,530	910	1,100	1,370	850	1,020	1,280	800	1,200	1,440	730	1,100	1,320	640	960	1,160	510	770	1,230
Vc = 80 m/min, fz = 0.3 mm/t																							
870	530	700	760	610	760	680	550	680	640	520	640	600	600	720	550	550	660	480	480	580	380	380	610
Vc = 60 m/min, fz = 0.2 mm/t																							

- The above table shows the conditions for standard shank type cutters. When using long shank type cutters, the number of teeth may be different. In this case, the cutting conditions should be changed by referring to: "The usage of standard and long shanks" shown in previous page

- Cutting conditions are generally limited by the rigidity and power of the machine and the rigidity of the workpiece. When setting the conditions, start from half of the values of the standard cutting conditions and then increase the value gradually while making sure the machine is running normally

APPLICATION RANGE

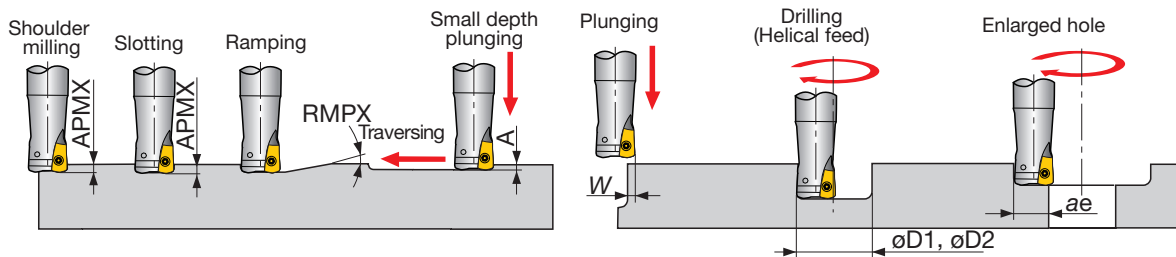

Designation	Tool dia.	Max. depth of cut	Max. ramping angle	Max. plunging depth	Max. cutting width in plunging	Min. machinable hole dia.	Max. machinable hole dia.	Max. cutting width in enlarged hole
	DCX	APMX	RMPX	A	W	øD1	øD2	ae
E/HXN03R016M...	ø16	0.9	Not possible	Not possible	3.8	Not possible	Not possible	12.2
E/HXN03R018M...	ø18	0.9	1.7°	0.27	3.8	26	34	14.2
E/HXN03R020M...	ø20	0.9	1.4°	0.27	3.8	30	38	16.2
E/HXN03R022M...	ø22	0.9	1.2°	0.27	3.8	34	42	18.2
E/HXN03R025M...	ø25	0.9	1°	0.27	3.8	40	48	21.2
E/HXN03R028M...	ø28	0.9	0.8°	0.27	3.8	46	54	24.2
E/HXN03R030M...	ø30	0.9	0.7°	0.27	3.8	50	58	26.2
E/HXN03R032M...	ø32	0.9	0.7°	0.27	3.8	54	62	28.2
EXN03R035M...	ø35	0.9	0.6°	0.27	3.8	60	68	31.2
E/H/TXN03R040M...	ø40	0.9	0.5°	0.27	3.8	70	78	36.2
TXN03R050M...	ø50	0.9	0.4°	0.27	3.8	90	98	46.2

- For øDc above ø33 mm, slot milling, ramping or contouring is not recommended as chips may be re-cut



High-feed milling

HIGH PERFORMANCE AND PROFITABILITY IN HIGH-FEED MILLING OPERATIONS

ADD more cutting edges per insert to your
machining operations





- The cutter features a small approach angle, providing smooth access into the material, making it an ideal tool for long overhang setups.
- Steep ramping capability makes the cutter ideal for pocketing and cavity milling applications.

- Large effective cutter diameter leaves less uncut material.

Lineup

Insert

- **WXMU03-MM**

Double-sided
 6-edged insert
 APMX = 1 mm

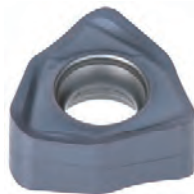

Chipbreaker

- **MM type:** Versatile geometry for low cutting forces

Grades

- **AH3225:** Provides superior resistance to wear and fracture, ideal for steel and stainless steel
- **AH8015:** Wear resistant grade, suited for hardened steel and cast iron

Cutter bodies

Bore type:

- **TXWX03...**

DCX = \varnothing 40 - \varnothing 50 mm

Shank type:

- **EXWX03...** (Short type)

DCX = \varnothing 16 - \varnothing 32 mm

- **EXWX03**L** (Long type)

DCX = \varnothing 16 - \varnothing 32 mm

Modular type:

- **HXWX03...**

DCX = \varnothing 16 - \varnothing 32 mm

Scan this QR code
 to find out more
 about this tool!



CUTTER

EXWX03

High feed endmill, shank type, with screw clamp system, for 6-corner double sided inserts

GAMP = +23°, GAMF = -7.9° ~ -6.2°

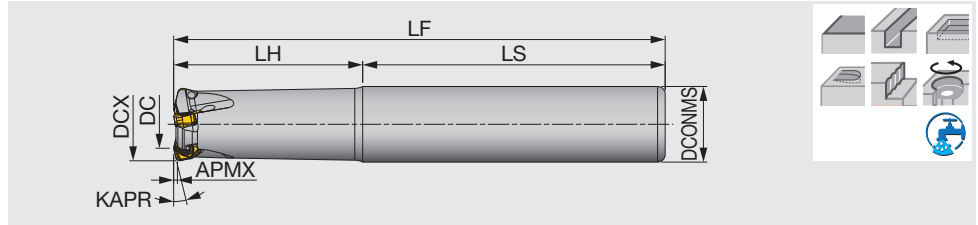

Designation	APMX	DCX	CICT	DC	DCONMS	LS	LH	LF	KAPR	WT(kg)	Air hole	Insert
EXWX03M016C16.0R02	1	16	2	8.9	16	70	30	100	12°	0.14	With	WXMU03...
EXWX03M016C16.0R02L	1	16	2	8.9	16	100	50	150	12°	0.21	With	WXMU03...
EXWX03M020C20.0R03	1	20	3	12.8	20	80	50	130	12°	0.26	With	WXMU03...
EXWX03M020C20.0R03L	1	20	3	12.8	20	80	80	160	12°	0.31	With	WXMU03...
EXWX03M025C25.0R04	1	25	4	17.8	25	80	60	140	12°	0.46	With	WXMU03...
EXWX03M025C25.0R04L	1	25	4	17.8	25	80	100	180	12°	0.58	With	WXMU03...
EXWX03M032C32.0R05	1	32	5	24.7	32	80	70	150	12°	0.84	With	WXMU03...
EXWX03M032C32.0R05L	1	32	5	24.7	32	80	120	200	12°	1.11	With	WXMU03...

TUNGFLEX

HXWX03-M

High feed endmill, modular type (TungFlex)

GAMP = +23°, GAMF = -7.9° ~ -6.2°

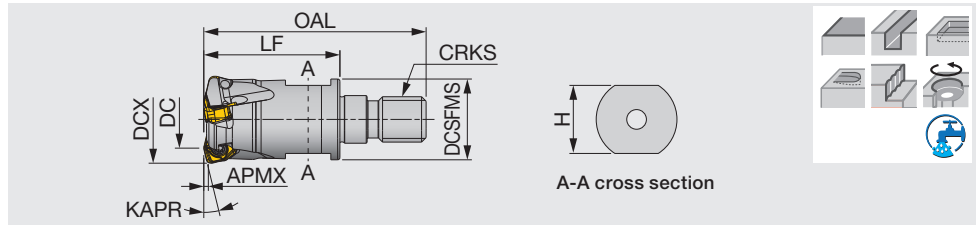

Designation	APMX	DCX	CICT	DC	OAL	LF	H	DCSFMS	KAPR	CRKS	WT(kg)	Air hole	Insert
HXWX03M016M08R02	1	16	2	8.9	42	25	10	12.8	12°	M8	0.03	With	WXMU03...
HXWX03M020M10R03	1	20	3	12.8	49	30	15	17.8	12°	M10	0.06	With	WXMU03...
HXWX03M025M12R04	1	25	4	17.8	57	35	17	20.8	12°	M12	0.1	With	WXMU03...
HXWX03M032M16R05	1	32	5	24.7	63	40	22	28.8	12°	M16	0.21	With	WXMU03...

TXWX03

High feed mill, with screw clamp system, for 6-corner double sided inserts

GAMP = +23°, GAMF = -6.2° ~ -6.1°

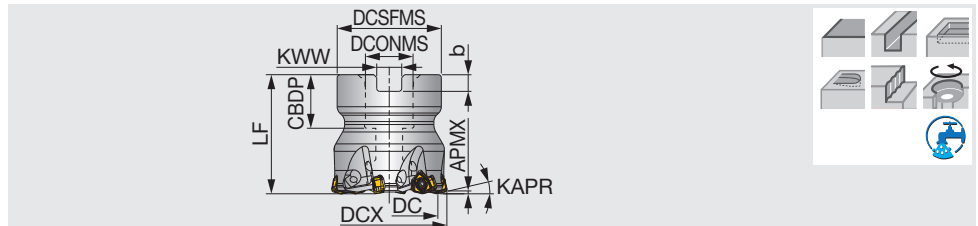

Designation	APMX	DCX	CICT	DC	DCSFMS	DCONMS	CBDP	LF	b	KWW	KAPR	WT(kg)	Air hole	Insert
TXWX03M040B16.0R06	1	40	6	32.7	35	16	18	40	5.6	8.4	12°	0.22	With	WXMU03...
TXWX03M050B22.0R08	1	50	8	42.7	47	22	20	50	6.3	10.4	12°	0.46	With	WXMU03...

INSERT

WXMU0303-MM

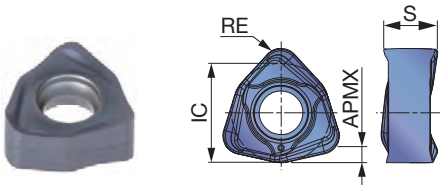

P	Steel	★	☆							
M	Stainless	★								
K	Cast iron	☆	★							
N	Non-ferrous									
S	Superalloy	☆	★							
H	Hard materials		★							

★ : First choice
☆ : Second choice

Designation	RE	APMX	Coated								IC	S	
			AH3225	AH8015									
WXMU0303ZER-MM	1.2	1	●	●								6.35	3.63

● : New

STANDARD CUTTING CONDITIONS

ISO	Workpiece materials	Hardness	Priority	Grades	Chipbreaker	Cutting speed Vc (m/min)	Feed per tooth fz (mm/t)
P	Low carbon steel S15C, SS400, etc. C15, C20, etc.	- 300HB	First choice	AH3225	MM	100 - 300	0.5 - 1.5
			For wear resistance	AH8015			
	Carbon steel, Alloy steel S55C, SCM440, etc. C55, 42CrMoS4, etc.	- 300HB	First choice	AH3225	MM	100 - 250	0.5 - 1.5
			For wear resistance	AH8015			
	Prehardened steel NAK80, PX5, etc.	30 - 40HRC	First choice	AH3225	MM	100 - 200	0.5 - 1.2
			For wear resistance	AH8015			
M	Austenitic Stainless steel SUS304, SUS316, etc. X5CrNi18-9, X5CrNiMo17-12-2, etc.	- 200HB	First choice	AH3225	MM	80 - 150	0.5 - 1
	Martensitic Stainless steel SUS410, SUS420J1, etc. X12Cr13, X20Cr13, etc.	- 200HB	First choice	AH3225	MM	50 - 120	0.3 - 1
K	Grey cast iron FC250, FC300, etc. 250, 300, etc.	150 - 250HB	First choice	AH8015	MM	100 - 300	0.5 - 1.5
			For impact resistance	AH3225			
K	Ductile cast iron FCD400, etc. 400-15, 600-3, etc.	150 - 250HB	First choice	AH8015	MM	80 - 200	0.5 - 1.5
			For impact resistance	AH3225			
S	Titanium alloy Ti-6Al-4V, etc.	- 40HRC	First choice	AH3225	MM	30 - 60	0.3 - 0.7
	Superalloys Inconel718, etc.	- 40HRC	First choice	AH8015	MM	20 - 50	0.1 - 0.3
H	Hardened steel	40 - 50HRC	First choice	AH8015	MM	80 - 150	0.1 - 0.5
			For impact resistance	AH3225			
		50 - 60HRC	First choice	AH8015	MM	50 - 70	0.03 - 0.1

APPLICATION RANGE

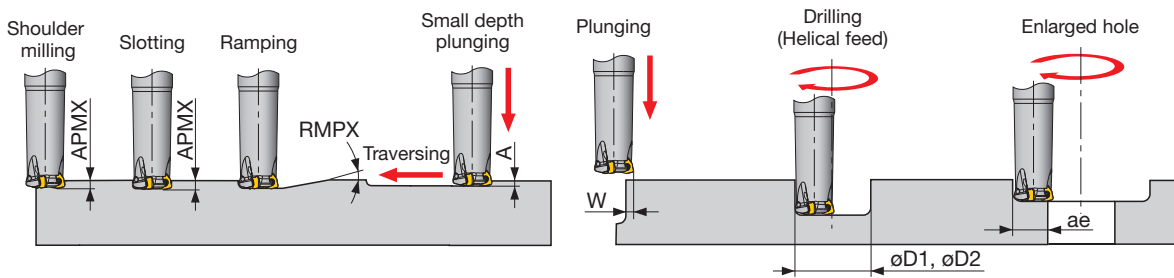

Designation	DCX	Max. depth of cut	Max. ramping angle	Max. plunging depth	Max. cutting width in plunging	Min. machinable hole dia.	Max. machinable hole dia.	Max. cutting width in enlarged hole
		APMX	RMPX	A	W	øD1	øD2	ae
E/HXWX03M016...	16	1	3	0.3	4	25	30	12
E/HXWX03M020...	20	1	2	0.3	4	31	38	16
E/HXWX03M025...	25	1	1.4	0.3	4	41	48	21
E/HXWX03M032...	32	1	1	0.3	4	54	62	28
TXWX03M040...	40	1	0.7	0.3	4	71	78	36
TXWX03M050...	50	1	0.6	0.3	4	87	98	46

Tool dia: DCX (mm), Number of revolution: n (min^{-1}), Feed speed: V_f (mm/min), Max. depth of cut: $APMX = 1$ mm, Number of teeth: CICT

$\phi 16$, CICT = 2		$\phi 20$, CICT = 3		$\phi 25$, CICT = 4		$\phi 32$, CICT = 5		$\phi 40$, CICT = 6		$\phi 50$, CICT = 8	
n	V_f	n	V_f	n	V_f	n	V_f	n	V_f	n	V_f
3,981	7,962	3,185	9,554	2,548	10,191	1,990	9,952	1,592	9,554	1,274	10,191
$V_c = 200$ m/min, $f_z = 1$ mm/t											
3,981	7,962	3,185	9,554	2,548	10,191	1,990	9,952	1,592	9,554	1,274	10,191
$V_c = 200$ m/min, $f_z = 1$ mm/t											
2,986	5,971	2,389	7,166	1,911	7,643	1,493	7,464	1,194	7,166	955	7,643
$V_c = 150$ m/min, $f_z = 0.7$ mm/t											
2,389	4,777	1,911	5,732	1,529	6,115	1,194	5,971	955	5,732	764	6,115
$V_c = 120$ m/min, $f_z = 0.5$ mm/t											
1,990	3,981	1,592	4,777	1,274	5,096	995	4,976	796	4,777	637	5,096
$V_c = 100$ m/min, $f_z = 0.3$ mm/t											
3,981	7,962	3,185	9,554	2,548	10,191	1,990	9,952	1,592	9,554	1,274	10,191
$V_c = 200$ m/min, $f_z = 1$ mm/t											
2,986	5,971	2,389	7,166	1,911	7,643	1,493	7,464	1,194	7,166	955	7,643
$V_c = 150$ m/min, $f_z = 1$ mm/t											
796	1,592	637	1,911	510	2,038	398	1,990	318	1,911	255	2,038
$V_c = 40$ m/min, $f_z = 0.4$ mm/t											
597	1,194	478	1,433	382	1,529	299	1,493	239	1,433	191	1,529
$V_c = 30$ m/min, $f_z = 0.2$ mm/t											
2,389	4,777	1,911	5,732	1,529	6,115	1,194	5,971	955	5,732	764	6,115
$V_c = 120$ m/min, $f_z = 0.3$ mm/t											
1,194	2,389	955	2,866	764	3,057	597	2,986	478	2,866	382	3,057
$V_c = 60$ m/min, $f_z = 0.1$ mm/t											

TOOL GEOMETRY ON PROGRAMMING

When programming for CAM, the tool should be considered as a radius cutter. Usually, the corner radius should be set as $R = 1.5$ mm. If a larger radius is used, overcutting will occur. The following table shows the amount left uncut (t_1) and overcut (t_2).

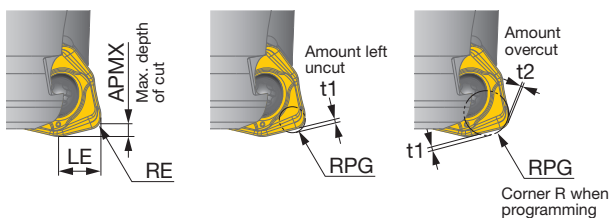

Max. depth of cut APMX (mm)	Corner radius RE (mm)	LE (mm)	Corner R when programming RPG	Amount left uncut t_1 (mm)	Amount overcut t_2 (mm)
1	1.2	3.5	1	0.56	-
1	1.2	3.5	1.5	0.46	-
1	1.2	3.5	2	0.35	0.16
1	1.2	3.5	2.5	0.2	0.5

*Recommended

TUNG-TRI

Square-shoulder milling

RIGIDITY AND RELIABILITY FOR SMALL SHOULDER MILLING OPERATIONS

ADD Productivity and surface quality with
optimized wiper insert design

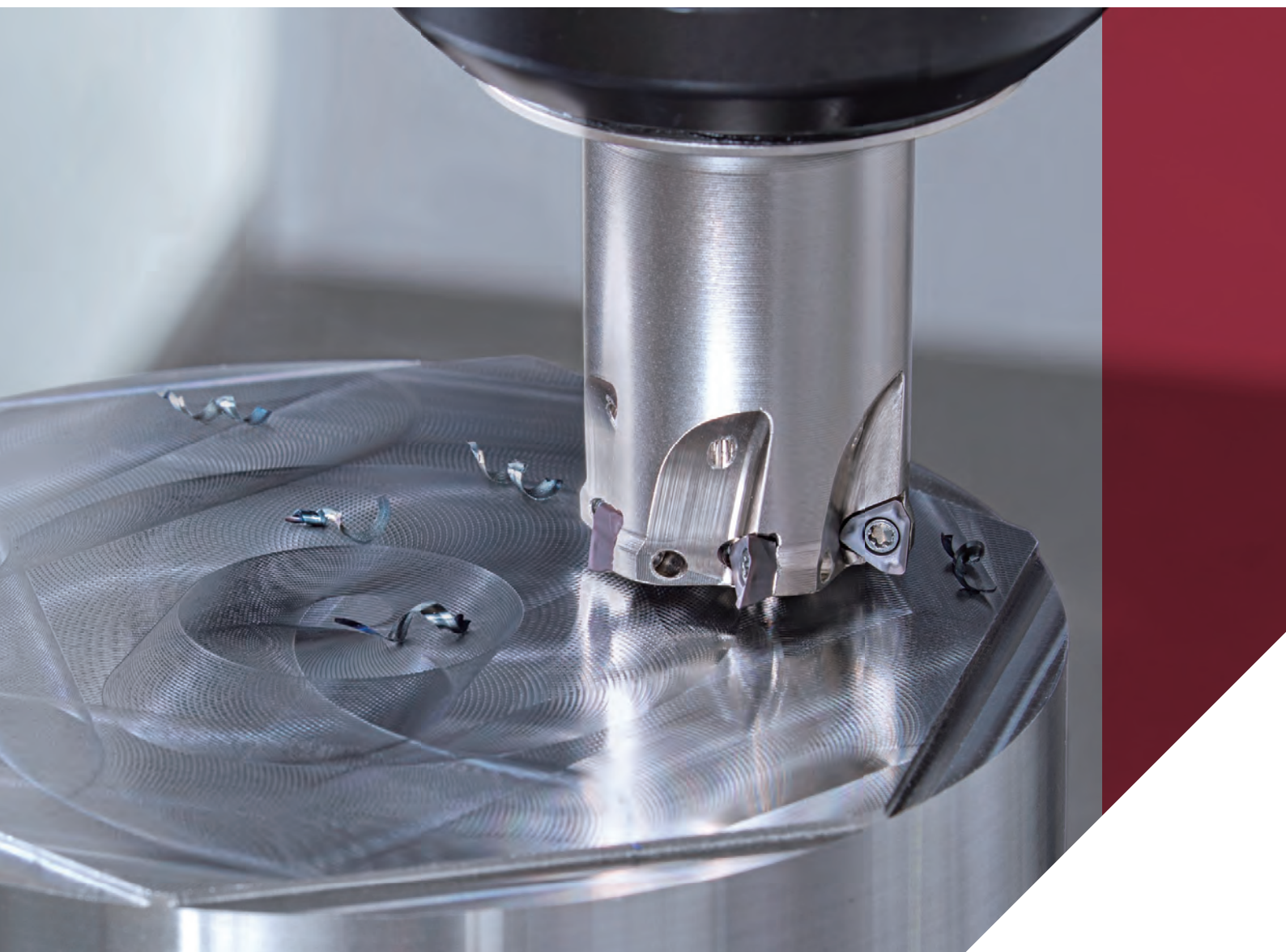



- Small 90° shoulder milling cutter down to $\varnothing 8$ mm for maximum performance.
- Close-pitch cutter for high efficiency machining.

- The thick core cutter diameter provides increased rigidity.

Lineup

Insert

- **TOMT04-MM**
 Single-sided
 3 edged insert
 APMX = 3.5 mm
 RE = 0.4, 0.8 mm



Chipbreaker

- **MM type:** Versatile geometry for low cutting forces

Cutter bodies

Shank type:

- **EPA04R...** (Short type)
 DC = $\varnothing 8$ - $\varnothing 25$ mm
- **EPA04R**L** (Long type)
 DC = $\varnothing 10$ - $\varnothing 25$ mm

Grades

- **AH3225:** Provides superior resistance to wear and fracture, ideal for steel and stainless steel
- **AH8015:** Wear resistant grade, suited for hardened steel and cast iron
- **AH120:** Provides a good balance of wear and chipping resistance, ideal grade for cast iron machining

Scan this QR code
 to find out more
 about this tool!



CUTTER

EPA04

High precision square shoulder endmill, shank type, with screw clamp system, for triangular inserts

GAMP = +12.1°~ +12.2°, GAMF = -14.2°~ -18.3°

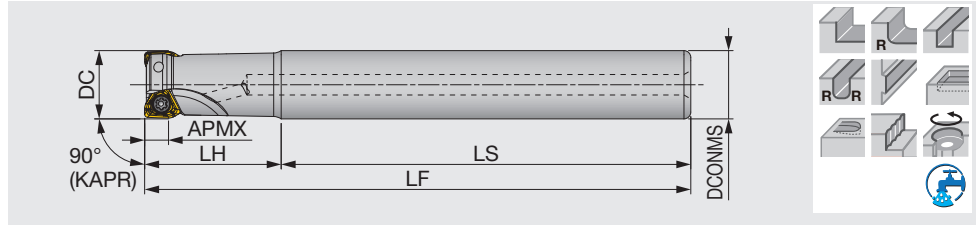

Designation	APMX	DC	CICT	DCONMS	LS	LH	LF	WT(kg)	Air hole	Insert
EPA04R008M08.0-01	3.5	8	1	8	48	12	60	0.02	with	TOMT04...
EPA04R010M10.0-02	3.5	10	2	10	60	20	80	0.04	with	TOMT04...
EPA04R010M10.0-02L	3.5	10	2	10	65	35	100	0.05	with	TOMT04...
EPA04R012M12.0-02	3.5	12	2	12	60	20	80	0.06	with	TOMT04...
EPA04R012M12.0-03	3.5	12	3	12	60	20	80	0.06	with	TOMT04...
EPA04R012M12.0-02L	3.5	12	2	12	85	35	120	0.09	with	TOMT04...
EPA04R016M16.0-03	3.5	16	3	16	70	20	90	0.12	with	TOMT04...
EPA04R016M16.0-04	3.5	16	4	16	70	20	90	0.12	with	TOMT04...
EPA04R016M16.0-03L	3.5	16	3	16	105	35	140	0.19	with	TOMT04...
EPA04R020M20.0-04	3.5	20	4	20	70	30	100	0.21	with	TOMT04...
EPA04R020M20.0-05	3.5	20	5	20	70	30	100	0.21	with	TOMT04...
EPA04R020M20.0-04L	3.5	20	4	20	165	35	200	0.44	with	TOMT04...
EPA04R025M25.0-05	3.5	25	5	25	80	35	115	0.39	with	TOMT04...
EPA04R025M25.0-06	3.5	25	6	25	80	35	115	0.39	with	TOMT04...
EPA04R025M25.0-04L	3.5	25	4	25	160	40	200	0.7	with	TOMT04...

INSERTS

TOMT-MM

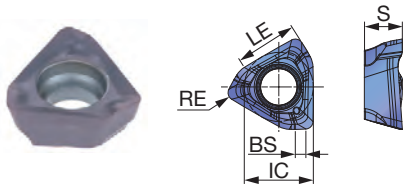

P	Steel	★	☆							
M	Stainless	★								
K	Cast iron		★							
N	Non-ferrous									
S	Superalloys	★		★						
H	Hard materials			★						

★ : First choice
☆ : Second choice

Designation	RE	APMX	Coated							LE	IC	S	BS	
			AH3225	AH120	AH8015									
TOMT040204PXER-MM	0.4	3.5	●	●	●						3.6	4	2.2	0.6
TOMT040208PXER-MM	0.8	3.5	●	●	●						3.6	4	2.2	0.2

● : New

STANDARD CUTTING CONDITIONS

EPA04

ISO	Workpiece materials	Hardness	Grades	Cutting speed Vc (m/min)	Feed per tooth fz (mm/t)
P	Low carbon steel SS400, S15C, etc. E275A, C15E4, etc.	- 200 HB	AH3225	100 - 250	0.05 - 0.12
	Carbon steel and alloy steel S55C, SCM440, etc. C55, 42CrMo4, etc.	- 300 HB	AH3225	100 - 230	0.05 - 0.12
	Prehardend steel NAK80, PX5, etc.	30 - 40 HRC	AH3225	100 - 180	0.05 - 0.1
M	Stainless steel SUS304, etc. X5CrNi18-9, etc.	-	AH3225	90 - 200	0.05 - 0.1
K	Grey cast iron FC250, etc. 250, etc., GGG25, etc.	150 - 250 HB	AH120	100 - 300	0.05 - 0.12
	Ductile cast iron FCD450, etc. 450-10S, etc., GGG45, etc.	150 - 250 HB	AH120	100 - 200	0.05 - 0.12
S	Titanium alloys Ti-6Al-4V, etc.	-	AH3225	20 - 60	0.04 - 0.07
	Heat-resistant alloys Inconel 718, etc.	-	AH8015	20 - 40	0.04 - 0.07
H	Hardened steel	SKD61, etc. X40CrMoV5-1, etc.	AH8015	50 - 150	0.04 - 0.07
		SKD11, etc. X153CrMoV12, etc.	AH8015	40 - 70	0.04 - 0.07

- Remove excessive chip accumulation with an air blast.
- For the operation with depth of cut which varies (ex.casting skin) and machining of workpiece materials with interrupted surface, the feed per tooth (fz) should be set to the lower recommended value shown in the above table.

- Cutting conditions may be limited depending on machine power, workpiece rigidity, and spindle output. When the cutting width, depth, or overhang length is large, set Vc and fz to the lower recommended values and check the machine power and vibration.

Square-shoulder milling

NEW SIZE-04 AND -12 INSERTS FOR ENHANCED SHOULDER MILLING CAPABILITY

ADD a broadened range of unique V-bottom shape inserts for higher productivity

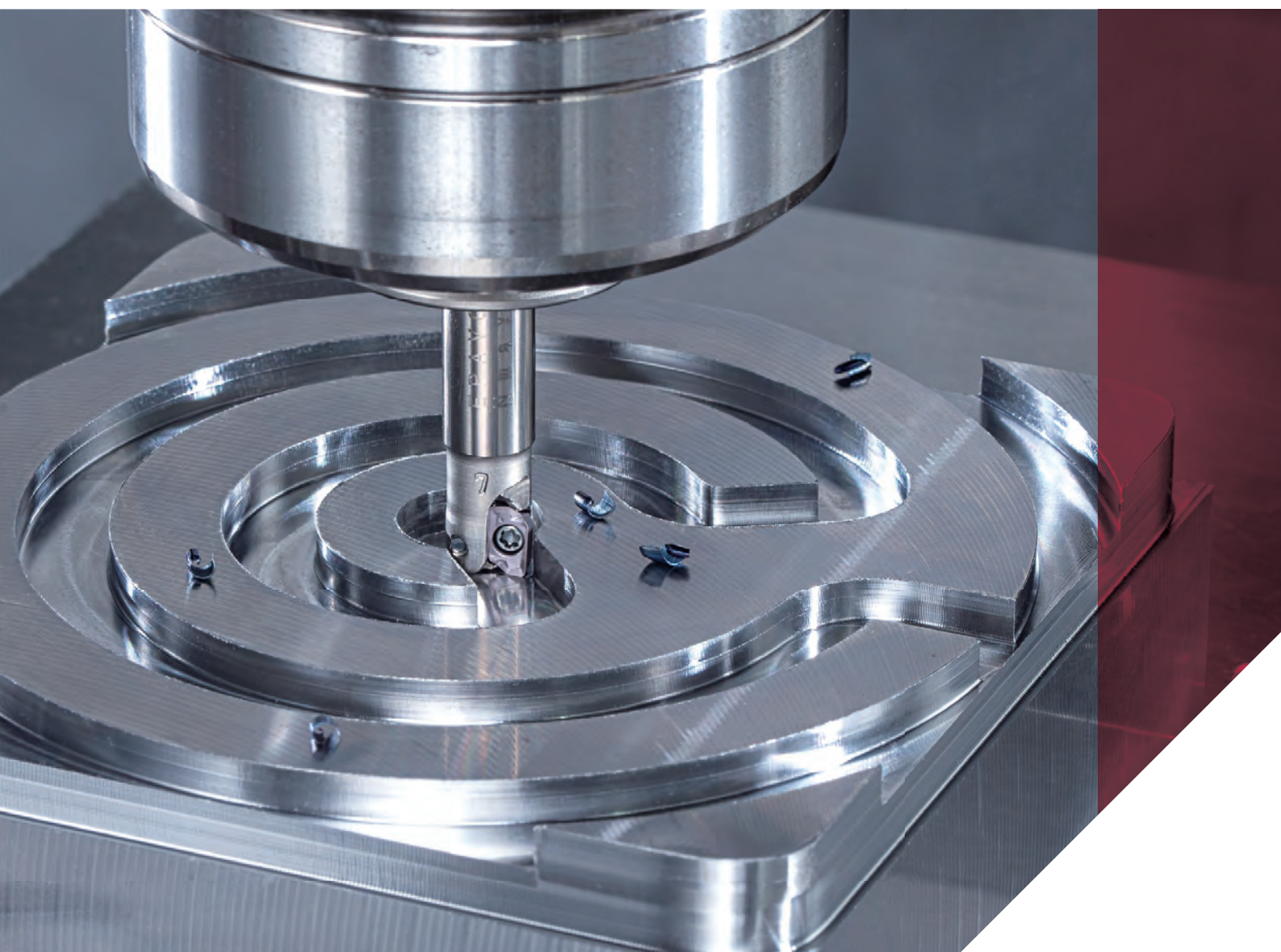



- The use of unique V-bottom shape inserts enables the cutter body to have a thicker core size and insert backing for higher tool rigidity.
- Close pitch cutter design for high efficiency milling.
- Light cutting action with high edge-line security thanks to large rake angle and strong cutting edge design.
- **Size-04 inserts** can be used for minimum cutter diameters from 6 mm.
- Large chip pockets for excellent chip evacuation.
- **Size-12 inserts** offer a variety of nose radii ranging from 0.4 to 3 mm and geometries including AM geometry for aluminum, covering a broader application range.

Lineup

Inserts

- **AVMT04-MM** : APMX = 4 mm, RE = 0.4, 0.8 mm
- **AVMT12-MM** : APMX = 11.5 mm, RE = 0.4 - 1.6 mm
APMX = 10.5 mm, RE = 2, 3 mm
- **AVGT12-AM** : APMX = 11.5 mm, RE = 0.4, 0.8 mm

Chipbreakers

- **MM type**: Versatile geometry for low cutting forces
- **AM type**: For non-ferrous applications

Grades

- **AH3225**: Superior resistance to wear and fracture, ideal for steel and stainless steel
- **AH120**: Excellent edge chipping resistance, suited for cast iron
- **T1215**: Wear-resistant grade suitable for cast iron
- **T3225**: Wear-resistant grade suitable for steel and stainless steel
- **KS05F**: Provides excellent edge-line security and wear resistance, perfect for non-ferrous applications

Cutter bodies

Shank type:

- **EPAV04...** (Short type)
DC = $\phi 6$ - $\phi 16$ mm
- **EPAV04**L** (Long type)
DC = $\phi 8$ - $\phi 16$ mm
- **EPAV12...** (Short type)
DC = $\phi 12$ - $\phi 32$ mm
- **EPAV12**L** (Long type)
DC = $\phi 16$ - $\phi 32$ mm

Bore type:

- **TPAV12...**
DC = $\phi 50$ - $\phi 63$ mm

Modular type:

- **HPAV12...**
DC = $\phi 16$ - $\phi 40$ mm

Scan this QR code to find out more about this tool!



CUTTER

EPAV04

High-end square shoulder endmill, with screw clamp system

GAMP = +6.0°~ +7.6°, GAMF = -37.1°~ -32.4°

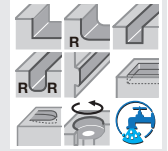
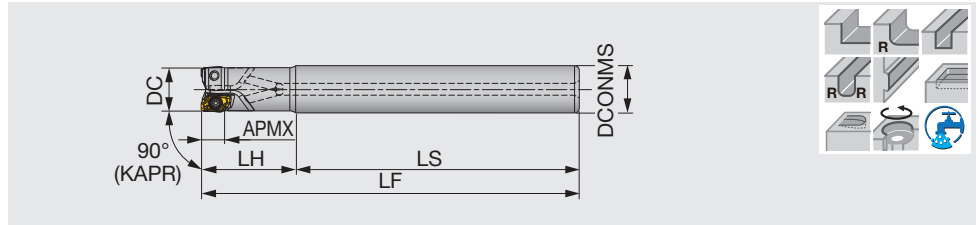

Designation	APMX	DC	CICT	DCONMS	LS	LH	LF	WT(kg)	Air hole	Insert
EPAV04M006C06.0R01	4	6	1	6	48	12	60	0.01	With	AVMT04...
EPAV04M008C08.0R02	4	8	2	8	48	12	60	0.02	With	AVMT04...
EPAV04M008C08.0R02L	4	8	2	8	60	20	80	0.03	With	AVMT04...
EPAV04M010C10.0R02	4	10	2	10	60	20	80	0.04	With	AVMT04...
EPAV04M010C10.0R03	4	10	3	10	60	20	80	0.04	With	AVMT04...
EPAV04M010C10.0R02L	4	10	2	10	65	35	100	0.05	With	AVMT04...
EPAV04M012C12.0R03	4	12	3	12	60	20	80	0.06	With	AVMT04...
EPAV04M012C12.0R04	4	12	4	12	60	20	80	0.06	With	AVMT04...
EPAV04M012C12.0R03L	4	12	3	12	85	35	120	0.09	With	AVMT04...
EPAV04M016C16.0R04	4	16	4	16	70	20	90	0.12	With	AVMT04...
EPAV04M016C16.0R05	4	16	5	16	70	20	90	0.12	With	AVMT04...
EPAV04M016C16.0R04L	4	16	4	16	105	35	140	0.19	With	AVMT04...

INSERT

AVMT04-MM

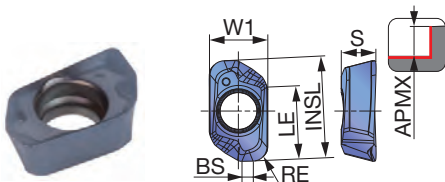

P	Steel	☆	★							
M	Stainless		★							
K	Cast iron	★								
N	Non-ferrous									
S	Superalloys	★	☆							
H	Hard materials	★								

★ : First choice
☆ : Second choice

Designation	RE	APMX	Coated								W1	INSL	S	BS	LE
			AH120	AH3225											
AVMT040204PPER-MM	0.4	4	●	●							3.5	6.05	2.1	1	4.4
AVMT040208PPER-MM	0.8	4	●	●							3.5	6.05	2.1	0.6	4.4

● : New

STANDARD CUTTING CONDITIONS

ISO	Workpiece materials	Hardness	Priority	Grades	Cutting speed Vc (m/min)	Feed per tooth fz (mm/t)	
P	Low carbon steel S15C, C15E, C15E4, etc. SS400, E275A, etc.	- 200 HB	First choice	AH3225	100 - 300	0.05 - 0.12	
	Carbon steel and alloy steel S55C, C55, etc. SCM440, 42CrMo4, etc.	- 300 HB	First choice	AH3225	100 - 250	0.05 - 0.12	
	Prehardend steel NAK80, PX5, etc.	30 - 40 HRC	First choice	AH3225	100 - 200	0.05 - 0.1	
M	Stainless steel SUS304, X5CrNi18-9, etc.	-	First choice	AH3225	80 - 180	0.05 - 0.1	
K	Grey cast iron FC250, GG25, 250, etc.	150 - 250 HB	First choice	AH120	100 - 300	0.05 - 0.12	
	Ductile cast iron FCD400, etc. FCD600, GGG60, 600-3, etc.	150 - 250 HB	First choice	AH120	100 - 250	0.05 - 0.12	
S	Titanium alloys Ti-6Al-4V, etc.	-	First choice	AH3225	20 - 60	0.04 - 0.07	
	Superalloys Inconel718, etc.	-	First choice	AH120	20 - 40	0.04 - 0.07	
H	Hardened steel	SKD61, X40CrMoV5-1, etc.	40 - 50 HRC	First choice	AH120	50 - 150	0.04 - 0.07
		SKD11, X153CrMoV12, etc.	50 - 60 HRC	First choice	AH120	40 - 70	0.04 - 0.07

MACHINING APPLICATIONS

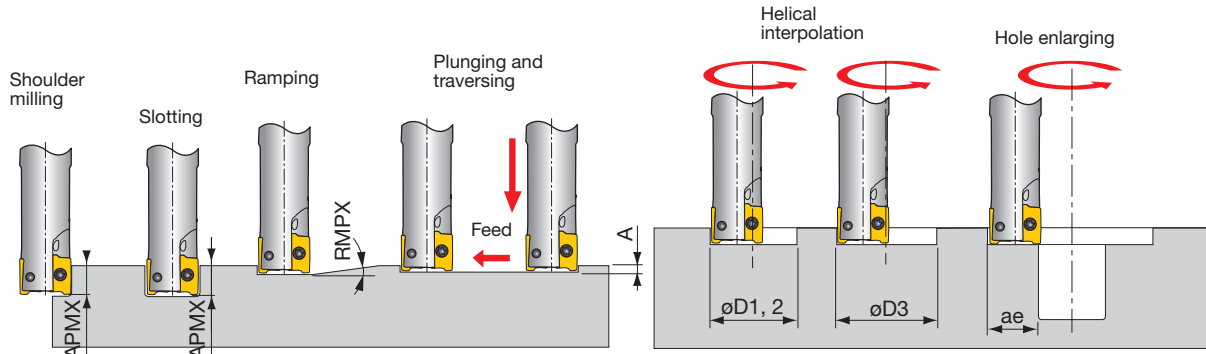

Designation	DC	Max. depth of cut		Max. plunging	Min. machining	Max. machining		Max. cutting width in enlarging
		APMX	RMPX			$\phi D1, 2$	$\phi D3^*$	
EPAV04M006C06.0R01	6	4	0.4	0.03	9.3	11.6	9.9	5.5
EPAV04M008C08.0R02	8	4	0.5	0.04	12.7	15.6	13.6	7.5
EPAV04M008C08.0R02L	8	4	0.5	0.04	12.7	15.6	13.6	7.5
EPAV04M010C10.0R02	10	4	4.1	0.4	15.3	19.6	17.5	9.5
EPAV04M010C10.0R03	10	4	1.7	0.2	16.1	19.6	17.5	9.5
EPAV04M010C10.0R02L	10	4	4.1	0.4	16.1	19.6	17.5	9.5
EPAV04M012C12.0R03	12	4	2.7	0.4	19.3	23.6	21.5	11.5
EPAV04M012C12.0R04	12	4	1.3	0.2	20.1	23.6	21.5	11.5
EPAV04M012C12.0R03L	12	4	2.7	0.4	19.3	23.6	21.5	11.5
EPAV04M016C16.0R04	16	4	2	0.4	27.2	31.6	29.5	15.5
EPAV04M016C16.0R05	16	4	2	0.4	27.2	31.6	29.5	15.5
EPAV04M016C16.0R04L	16	4	2	0.4	27.2	31.6	29.5	15.5

*Flat bottom hole

When clamping the insert, please confirm that there is no gap between the cutter body and the insert as shown in the picture.

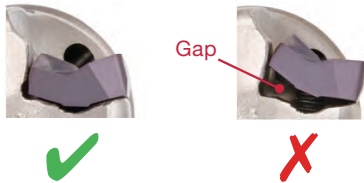

Estimation of chip thickness - calculated from feed per tooth (f_z) and width of cut (ae)

Recommended chip thickness

Feed per tooth f_z (mm/t)	Cutting width (%): ae (mm) / Tool dia.: DC (mm)														
	1%	2%	2.5%	3%	4%	5%	10%	15%	20%	25%	30%	35%	40%	45%	50% -
0.03	0.006	0.008	0.009	0.01	0.012	0.013	0.018	0.021	0.024	0.026	0.027	0.029	0.029	0.03	0.03
0.05	0.01	0.014	0.016	0.017	0.02	0.022	0.03	0.036	0.04	0.043	0.046	0.048	0.049	0.05	0.05
0.08	0.016	0.022	0.025	0.027	0.031	0.035	0.048	0.057	0.064	0.069	0.073	0.076	0.078	0.08	0.08
0.1	0.02	0.028	0.031	0.034	0.039	0.044	0.06	0.071	0.08	0.087	0.092	0.095	0.098	0.099	0.1
0.12	0.024	0.034	0.037	0.041	0.047	0.052	0.072	0.086	0.096	0.104	0.11	0.114	0.118	0.119	0.12
0.15	0.03	0.042	0.047	0.051	0.059	0.065	0.09	0.107	0.12	0.13	0.137	0.143	0.147	0.149	0.15
0.18	0.036	0.05	0.056	0.061	0.071	0.078	0.108	0.129	0.144	0.156	0.165	0.172	0.176	0.179	0.18
0.2	0.04	0.056	0.062	0.068	0.078	0.087	0.12	0.143	0.16	0.173	0.183	0.191	0.196	0.199	0.2
0.22	0.044	0.062	0.069	0.075	0.086	0.096	0.132	0.157	0.176	0.191	0.202	0.21	0.216	0.219	0.22
0.25	0.05	0.07	0.078	0.085	0.098	0.109	0.15	0.179	0.2	0.217	0.229	0.238	0.245	0.249	0.25
0.28	0.056	0.078	0.087	0.096	0.11	0.122	0.168	0.2	0.224	0.242	0.257	0.267	0.274	0.279	0.28
0.3	0.06	0.084	0.094	0.102	0.118	0.131	0.18	0.214	0.24	0.26	0.275	0.286	0.294	0.298	0.3
0.4	0.08	0.112	0.125	0.136	0.157	0.174	0.24	0.286	0.32	0.346	0.367	0.382	0.392	0.398	0.4

CUTTER

EPAV12

High-end square shoulder endmill, with screw clamp system

GAMP = +6.0°~ +7.6°, GAMF = -37.1°~ -32.4°

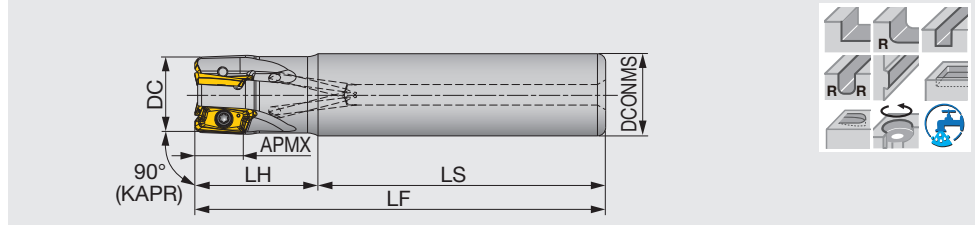

Designation	APMX	DC	CICT	DCONMS	LS	LH	LF	WT(kg)	Air hole	Insert
EPAV12M012C12.0R01	11.5	12	1	12	60	25	85	0.06	With	AVM/GT12...
EPAV12M016C16.0R02	11.5	16	2	16	60	25	85	0.12	With	AVM/GT12...
EPAV12M016C16.0R03	11.5	16	3	16	60	25	85	0.12	With	AVM/GT12...
EPAV12M016C16.0R02L	11.5	16	2	16	105	40	145	0.20	With	AVM/GT12...
EPAV12M020C20.0R03	11.5	20	3	20	70	30	100	0.22	With	AVM/GT12...
EPAV12M020C20.0R04	11.5	20	4	20	70	30	100	0.21	With	AVM/GT12...
EPAV12M020C20.0R02L	11.5	20	2	20	135	50	185	0.41	With	AVM/GT12...
EPAV12M025C25.0R04	11.5	25	4	25	80	35	115	0.38	With	AVM/GT12...
EPAV12M025C25.0R06	11.5	25	6	25	80	35	115	0.39	With	AVM/GT12...
EPAV12M025C25.0R03L	11.5	25	3	25	150	70	220	0.74	With	AVM/GT12...
EPAV12M032C32.0R06	11.5	32	6	32	80	40	120	0.68	With	AVM/GT12...
EPAV12M032C32.0R08	11.5	32	8	32	80	40	120	0.68	With	AVM/GT12...
EPAV12M032C32.0R03L	11.5	32	3	32	175	80	255	1.47	With	AVM/GT12...

HPAV12-M

High-end square shoulder mill, modular type (TungFlex)

GAMP = +6.0°~ +7.6°, GAMF = -37.1°~ -32.4°

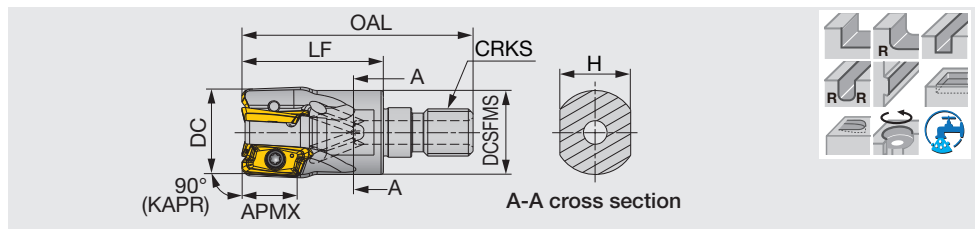

Designation	APMX	DC	CICT	OAL	LF	H	DCSFMS	CRKS	WT(kg)	Air hole	Insert
HPAV12M016M08R02	11.5	16	2	42	25	10	14.5	M8	0.03	With	AVM/GT12...
HPAV12M016M08R03	11.5	16	3	42	25	10	14.5	M8	0.03	With	AVM/GT12...
HPAV12M020M10R03	11.5	20	3	49	30	15	17.8	M10	0.06	With	AVM/GT12...
HPAV12M020M10R04	11.5	20	4	49	30	15	17.8	M10	0.05	With	AVM/GT12...
HPAV12M025M12R04	11.5	25	4	57	35	17	23	M12	0.1	With	AVM/GT12...
HPAV12M025M12R06	11.5	25	6	57	35	17	23	M12	0.1	With	AVM/GT12...
HPAV12M032M16R06	11.5	32	6	63	40	22	28.8	M16	0.21	With	AVM/GT12...
HPAV12M032M16R08	11.5	32	8	63	40	22	28.8	M16	0.21	With	AVM/GT12...
HPAV12M040M16R06	11.5	40	6	63	40	22	28.8	M16	0.25	With	AVM/GT12...
HPAV12M040M16R08	11.5	40	8	63	40	22	28.8	M16	0.24	With	AVM/GT12...

CUTTER

TPAV12

High-end square shoulder mill, with screw clamp system

GAMP = +6.0°~ +7.6°, GAMF = -37.1°~ -32.4°

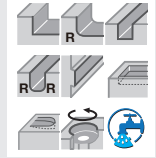
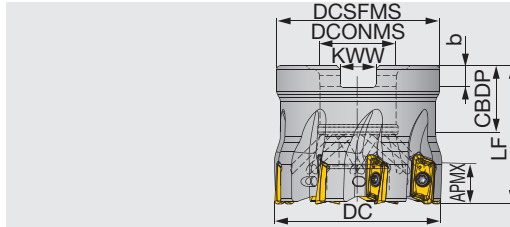

Designation	APMX	DC	CICT	DCSFMS	DCONMS	CBDP	LF	KWW	b	WT(kg)	Air hole	Insert
TPAV12M050B22.0R08	11.5	50	8	47	22	20	40	10.4	6.3	0.37	With	AVM/GT12...
TPAV12M050B22.0R12	11.5	50	12	47	22	20	40	10.4	6.3	0.37	With	AVM/GT12...
TPAV12M063B22.0R08	11.5	63	8	47	22	20	40	10.4	6.3	0.52	With	AVM/GT12...
TPAV12M063B22.0R14	11.5	63	14	47	22	20	40	10.4	6.3	0.54	With	AVM/GT12...

INSERT

AVMT-MM

AVGT-AM

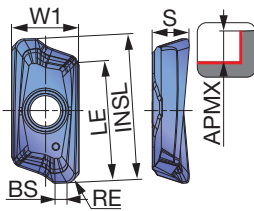

Fig. 1

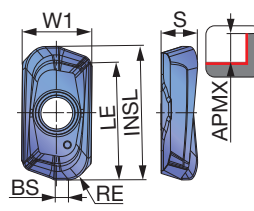

Fig. 2

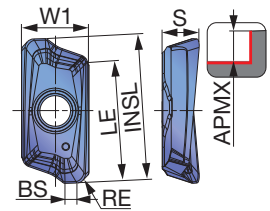

Fig. 3

P	Steel		★	☆								
M	Stainless		★	☆								
K	Cast iron	★		☆								
N	Non-ferrous				★							
S	Superalloys	★	★									
H	Hard materials	★										

★ : First choice
☆ : Second choice

Designation	RE	APMX	Coated		Carbide	W1	INSL	S	BS	LE	Fig.
			AH120	AH3225	T1215						
AVMT120404PDER-MM	0.4	11.5	●	●	●	●	●	●	●	●	1
AVMT120408PDER-MM	0.8	11.5	●	●	●	●	●	●	●	●	1
AVMT120412PDER-MM	1.2	11.5	●	●	●	●	●	●	●	●	1
AVMT120416PDER-MM	1.6	11.5	●	●	●	●	●	●	●	●	1
AVMT120420PDER-MM	2	10.5	●	●	●	●	●	●	●	●	2
AVMT120430PDER-MM	3	10.5	●	●	●	●	●	●	●	●	2
AVGT120404PDFR-AM	0.4	11.5			●	●	●	●	●	●	3
AVGT120408PDFR-AM	0.8	11.5			●	●	●	●	●	●	3

● : New

STANDARD CUTTING CONDITIONS

ISO	Workpiece materials	Hardness	Priority	Grades	Cutting speed Vc (m/min)	Feed per tooth fz (mm/t)	
P	Low carbon steel S15C, SS400, etc. C15E, E275A, etc.	- 200 HB	First choice	AH3225	100 - 300	0.06 - 0.22	
		- 200 HB	Wear resistance	T3225	200 - 400	0.06 - 0.18	
	Carbon steel and alloy steel S55C, SCM440, etc. C55, 42CrMo4, etc.	- 300 HB	First choice	AH3225	100 - 250	0.06 - 0.22	
		- 300 HB	Wear resistance	T3225	200 - 400	0.06 - 0.18	
	Prehardened steel NAK80, PX5, etc.	30 - 40 HRC	First choice	AH3225	100 - 200	0.06 - 0.22	
		30 - 40 HRC	Wear resistance	T3225	200 - 400	0.06 - 0.15	
M	Stainless steel SUS304, SUS316, etc. X5CrNi18-9, X5CrNiMo17-12-3, etc.	-	First choice	AH3225	80 - 180	0.07 - 0.2	
K	Grey cast iron FC250, FC300, etc. 250, 300, etc.	150 - 250 HB	First choice	AH120	100 - 300	0.05 - 0.12	
		150 - 250 HB	Wear resistance	T1215	200 - 400	0.05 - 0.18	
	Ductile cast iron FCD400, FCD600, etc. 400-15S, 600-3, etc.	150 - 250 HB	First choice	AH120	100 - 250	0.05 - 0.12	
		150 - 250 HB	Wear resistance	T1215	150 - 300	0.05 - 0.18	
N	Aluminum alloys Si < 13%	-	First choice	KS05F	300 - 1500	0.05 - 0.32	
	Aluminum alloys Si ≥ 13%	-	First choice	KS05F	100 - 200	0.05 - 0.32	
S	Titanium alloys Ti-6Al-4V, etc.	- 40 HRC	First choice	AH3225	20 - 60	0.04 - 0.15	
	Superalloys Inconel718, etc.	- 40 HRC	First choice	AH120	20 - 40	0.04 - 0.15	
H	Hardened steel	SKD61, etc. X40CrMoV5-1, etc.	40 - 50 HRC	First choice	AH120	50 - 150	0.04 - 0.07
		SKD11, etc. X153CrMoV12, etc.	50 - 60 HRC	First choice	AH120	40 - 70	0.04 - 0.07

CAUTIONARY POINT IN MODIFYING CUTTER BODIES

When using inserts with corner radius RE ≥ 2 mm, standard cutter bodies have to be modified "R". (EPAV12, TPAV12, HPAV12)

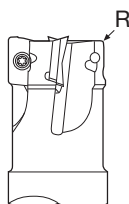

Corner radius RE (mm)	The dimension of modifying (mm)
0.4 - 1.6	Unnecessary
2 - 3	2

DOM^{ULTI} REC

Milling, Drilling (Multi-function)

ULTIMATE ALL-ROUND CUTTER

ADD multifunctional milling capability from drilling to square shoulder milling and counterboring





- A single insert has cutting edges for both bottom and peripheral surfaces. Four total cutting edges for better cost per insert.
- Negative insert with robust design.

- Through using helical interpolation method, flat-bottom holes of any diameter (\geq the cutter diameter +2 mm) can be made.
- Perfect for counterboring.

Lineup



Inserts

- LXMU08-MM

APMX = 7 mm (ZEFP = 1), 4 mm (ZEFP = 2)
 RE = 0.4 mm

- LXMU10-MM

APMX = 9 mm (ZEFP = 1), 4 mm (ZEFP = 2)
 RE = 0.8 mm

- LXMU12-MM

APMX = 11 mm (ZEFP = 1), 6 mm (ZEFP = 2)
 RE = 0.8 mm

Chipbreaker

- **MM type:** Versatile geometry for low cutting forces

Grades

- **AH3225:** Superior resistance to wear and fracture, ideal for steel and stainless steel
- **AH8015:** Wear-resistant grade ideal for hardened steel and cast iron
- **AH120:** Excellent edge chipping resistance, suited for cast iron

Cutter bodies

Shank type:

- **EVLX08...** (Short type)

DC = \varnothing 16 mm

- **EVLX08**L** (Long type)

DC = \varnothing 16, \varnothing 17 mm

- **EVLX10...** (Short type)

DC = \varnothing 20 mm

- **EVLX10**L** (Long type)

DC = \varnothing 20, \varnothing 21 mm

- **EVLX12...** (Short type)

DC = \varnothing 25 mm

- **EVLX12**L** (Long type)

DC = \varnothing 25, \varnothing 26 mm

Modular type:

- **HVLX08...**

DC = \varnothing 16 mm

- **HVLX10...**

DC = \varnothing 20 mm

- **HVLX12...**

DC = \varnothing 25 mm

Scan this QR code
 to find out more
 about this tool!



CUTTER

EVLX08/10/12

Multi-function endmill, shank type, with center cutting edge

GAMP: Center insert $-2.6^{\circ} \sim -4.4^{\circ}$, Peripheral insert $+6.1^{\circ} \sim +7.1^{\circ}$
 GAMF: Center insert $+0.2^{\circ} \sim +1.3^{\circ}$, Peripheral insert $15.7^{\circ} \sim -15^{\circ}$

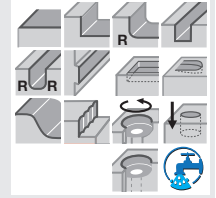
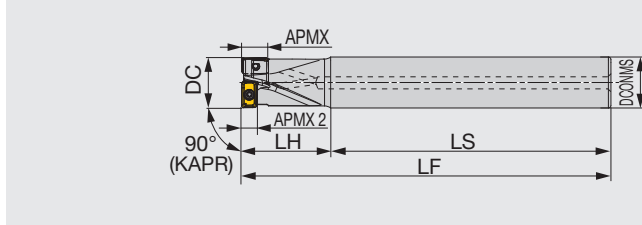

Designation	APMX	APMX 2	DC	CICT	DCONMS	LS	LH	LF	WT(kg)	Air hole	Insert
EVLX08M016C16.0R02	7	4	16	2	16	100	30	130	0.18	With	LXMU08...
EVLX08M016C16.0R02L	7	4	16	2	16	130	50	180	0.25	With	LXMU08...
EVLX08M017C16.0R02L	7	4	17	2	16	155	25	180	0.26	With	LXMU08...
EVLX10M020C20.0R02	9	4	20	2	20	110	35	145	0.31	With	LXMU10...
EVLX10M020C20.0R02L	9	4	20	2	20	130	60	190	0.41	With	LXMU10...
EVLX10M021C20.0R02L	9	4	21	2	20	160	30	190	0.42	With	LXMU10...
EVLX12M025C25.0R02	11	6	25	2	25	105	45	150	0.51	With	LXMU12...
EVLX12M025C25.0R02L	11	6	25	2	25	150	75	225	0.77	With	LXMU12...
EVLX12M026C25.0R02L	11	6	26	2	25	190	35	225	0.8	With	LXMU12...

HVLX08/10/12-M

Multi-function endmill, modular type (TungFlex), with center cutting edge

GAMP: Center insert $-2.6^{\circ} \sim -4.4^{\circ}$, Peripheral insert $+6.1^{\circ} \sim +7.1^{\circ}$
 GAMF: Center insert $+0.2^{\circ} \sim +1.3^{\circ}$, Peripheral insert $15.7^{\circ} \sim -15^{\circ}$

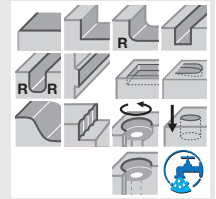
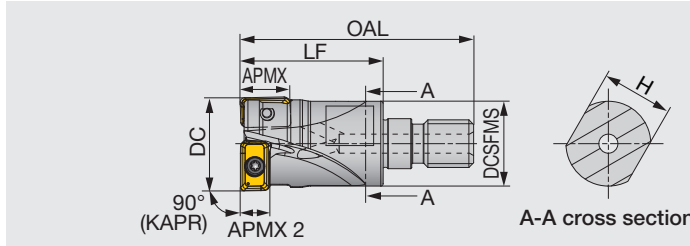

Designation	APMX	APMX 2	DC	CICT	OAL	LF	H	DCSFMS	CRKS	WT(kg)	Air hole	Insert
HVLX08M016M08R02	7	4	16	2	42	25	10	14.5	M8	0.03	With	LXMU08...
HVLX10M020M10R02	9	4	20	2	49	30	15	17.8	M10	0.05	With	LXMU10...
HVLX12M025M12R02	11	6	25	2	57	35	17	23	M12	0.1	With	LXMU12...

INSERT

LXMU-MM

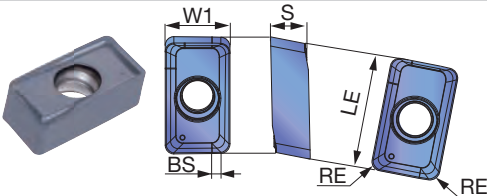

	P	M	K	N	S	H
Steel	★ ☆					
Stainless	★					
Cast iron		★				
Non-ferrous				★		
Superalloys	☆				★	
Hard materials						★

★ : First choice
 ☆ : Second choice

Designation	RE	APMX	Coated			LE	W1	S	BS
			AH3225	AH120	AH8015				
LXMU080304PER-MM	0.4	7	●	●	●	7.7	5	2.8	0.8
LXMU10T308PER-MM	0.8	9	●	●	●	10	6	3.214	0.8
LXMU120408PER-MM	0.8	11	●	●	●	12.2	7.08	4.176	0.8

● : New

STANDARD CUTTING CONDITIONS

ISO	Workpiece materials	Hardness	Priority	Grades	Cutting speed Vc (m/min)	Drilling	Feed per tooth: fz (mm/t)		
							Shouldering / Helical interpolation		
							08	10 / 12	
P	Low carbon steel S15C, SS400, etc. C15E4, E275A, etc.	- 200 HB	First choice	AH3225	100 - 300	0.03 - 0.08	0.05 - 0.25	0.05 - 0.3	
	Carbon steel and alloy steel S55C, SCM440, etc. C55, 42CrMo4, etc.	- 300 HB	First choice	AH3225	100 - 250	0.03 - 0.08	0.05 - 0.25	0.05 - 0.3	
	Prehardened steel NAK80, PX5, etc.	30 - 40 HRC	First choice	AH3225	100 - 200	0.03 - 0.06	0.05 - 0.2	0.05 - 0.25	
M	Stainless steel SUS304, SUS316, etc. X5CrNi18-9, X5CrNiMo17-12-3, etc.	-	First choice	AH3225	80 - 180	0.03 - 0.08	0.05 - 0.2	0.05 - 0.22	
K	Grey cast iron FC250, FC300, etc. 250, 300, etc.	150 - 250 HB	First choice	AH120	100 - 300	0.03 - 0.1	0.05 - 0.25	0.05 - 0.3	
	Ductile cast iron FCD400, FCD600, etc. 400-15S, 600-3, etc.	150 - 250 HB	First choice	AH120	100 - 250	0.03 - 0.08	0.05 - 0.2	0.05 - 0.25	
S	Titanium alloys Ti-6Al-4V, etc.	-	First choice	AH3225	20 - 60	0.03 - 0.06	0.04 - 0.15	0.04 - 0.15	
	Superalloys Inconel718, etc.	-	First choice	AH8015	20 - 40	0.03 - 0.06	0.04 - 0.15	0.04 - 0.15	
H	Hardened steel	SKD61, etc. X40CrMoV5-1, etc.	40 - 50 HRC	First choice	AH8015	50 - 150	0.03 - 0.05	0.04 - 0.15	0.04 - 0.15
		SKD11, etc. X153CrMoV12, etc.	50 - 60 HRC	First choice	AH8015	40 - 70	0.03 - 0.05	0.04 - 0.15	0.04 - 0.15

*When using depth of cut \geq "APMX 2", feed rate has to set by 1 tooth.

APPLICATION RANGE

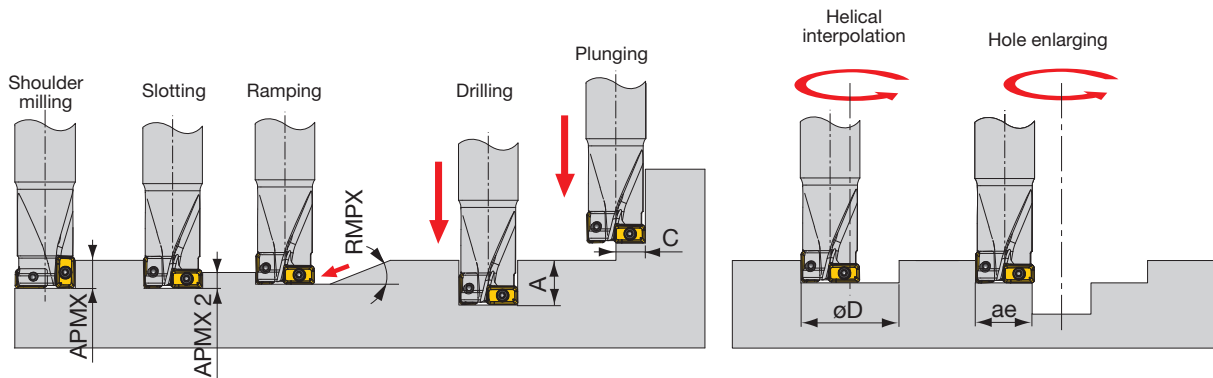

Designation	DC	Max. depth of cut		Max. drilling depth A	Max. cutting width in plunging C	Max. ramping angle RMPX	Hole diameters (w/ flat bottom) machinable		Hole diameters machinable		Max. cutting width engagement ae
		APMX	APMX 2				ϕ Dmin	ϕ Dmax	ϕ Dmin	ϕ Dmax	
E/HVLX08M016...	16	7	4	12	8	90°	17	30.75	16	31.75	14
EVLX08M017...	17	7	4	12	8.5	90°	19	32.75	17	33.75	15
E/HVLX10M020...	20	9	4	15	10	90°	22	37.95	20	39.15	18
EVLX10M021...	21	9	4	15	10.5	90°	23.35	39.95	21	40.95	19
E/HVLX12M025...	25	11	6	18.5	12.5	90°	26.65	47.85	25	48.95	23
EVLX12M026...	26	11	6	18.5	13	90°	28.65	49.85	26	50.95	24

*Use pecking or dwelling method when drilling holes deeper than 5 mm.

TUNGMEISTER

End milling

MORE THAN 13,000 POSSIBLE COMBINATIONS

ADD an extensive array of exchangeable milling heads for higher productivity

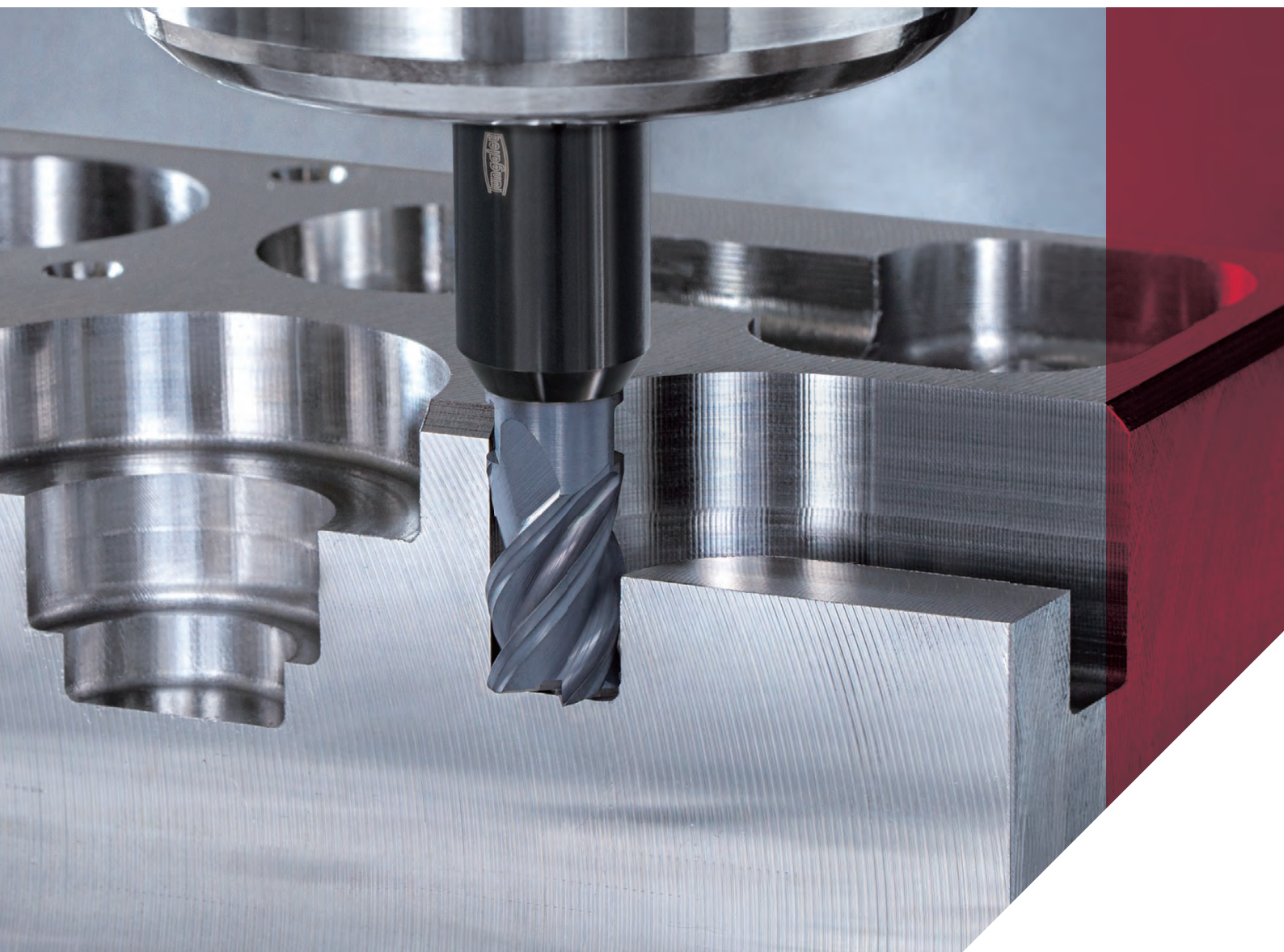



- Easy and accurate head-shank coupling provides reduced tool change time and high accuracy of cutting point repeatability.
- Offers solutions for square shoulder milling, high feed milling, profile milling, chamfering, hole making, and slotting.

- A flexible mix of heads and shanks allows an optimum tool assembly in all end milling applications.

Lineup

Heads

- Square: DC = $\varnothing 5$ - $\varnothing 32$ mm
- Face mill: DC = $\varnothing 12$ - $\varnothing 25$ mm
- High feed: DCX = $\varnothing 12$ - $\varnothing 16$ mm
- Ball: DC = $\varnothing 5$ - $\varnothing 25$ mm
- Barrel: DC = $\varnothing 8$ - $\varnothing 16$ mm
- Bull nose: DC = $\varnothing 10$ - $\varnothing 16$ mm
- Lens: DC = $\varnothing 8$ - $\varnothing 16$ mm
- Chamfering: DC = $\varnothing 10$ - $\varnothing 20$ mm
- Chamfering spot drill: DC = $\varnothing 8$ - $\varnothing 16$ mm
- Center hole: DC = $\varnothing 1.07$ - $\varnothing 6.41$ mm

Grades

- **AH715:** Wear-resistant grade suited for steel and hard materials
- **AH725:** Versatile grade with a good balance of wear and fracture resistance, ideal for all material groups
- **AH750:** Fracture resistant, improves machining efficiency in ISO H materials
- **KS15F:** Designed for non-ferrous applications

Shanks

- Cylindrical shank, straight neck
DCONMS = $\varnothing 8$ - $\varnothing 32$ mm
- Weldon shank, straight neck
DCONMS = $\varnothing 12$ - $\varnothing 25$ mm
- Cylindrical shank, taper neck
DCONMS = $\varnothing 8$ - $\varnothing 40$ mm
- High rigidity shank (cylindrical)
DCONMS = $\varnothing 6$ - $\varnothing 40$ mm
- Straight shank for slotting (cylindrical)
DCONMS = $\varnothing 6$ - $\varnothing 16$ mm
- Adaptor for **TungFlex**
CRKSMS = M8 - M12
- Adaptor for **ER collet**
SS = ER11 - ER16

Scan this QR code
to find out more
about this tool!



HEADS

VEH...

4 flute, roughing - finishing, variable helix and pitch

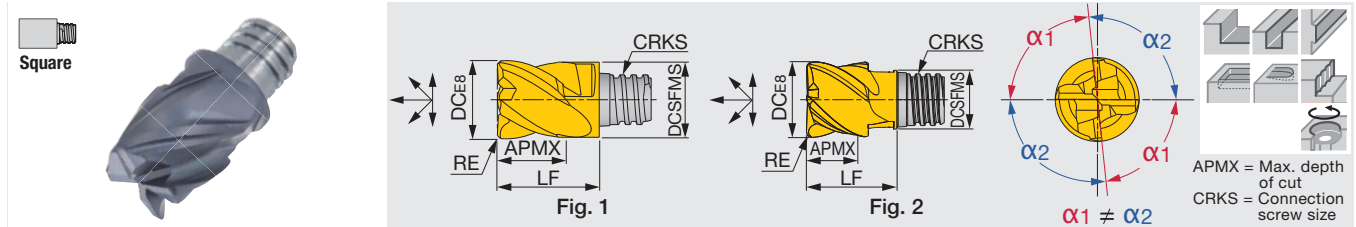

Designation	AH715	AH725	NOF	FHA	DC	DCSFMS	APMX	RE	CRKS	LF	Wrench	Torque*	Fig.
VEH080L05.0R05I04S05	●	●	4	41° - 45°	8	7.7	5	0.5	S05	10	KEYV-S05	7	1
VEH080L05.0R10I04S05	●	●	4	41° - 45°	8	7.7	5	1	S05	10	KEYV-S05	7	1
VEH100L07.0R10I04S05	●	●	4	41° - 45°	10	7.7	7	1	S05	12.8	KEYV-S05	7	2
VEH100L07.0R05I04S06	●	●	4	41° - 45°	10	9.7	7	0.5	S06	13	KEYV-S06	10	1
VEH100L07.0R10I04S06	●	●	4	41° - 45°	10	9.7	7	1	S06	13	KEYV-S06	10	1
VEH120L09.0R10I04S06	●	●	4	41° - 45°	12	9.3	9	1	S06	14.3	KEYV-S06	10	2
VEH120L09.0R05I04S08	●	●	4	41° - 45°	12	11.7	9	0.5	S08	16.5	KEYV-S08	15	1
VEH120L09.0R10I04S08	●	●	4	41° - 45°	12	11.7	9	1	S08	16.5	KEYV-S08	15	1
VEH160L12.0R10I04S08	●	●	4	41° - 45°	16	11.7	12	1	S08	20	KEYV-S08	15	2
VEH160L12.0R05I04S10	●	●	4	41° - 45°	16	15.3	12	0.5	S10	20.5	KEYV-S10	28	1
VEH160L12.0R10I04S10	●	●	4	41° - 45°	16	15.3	12	1	S10	20.5	KEYV-S10	28	1
VEH200L15.0R05I04S12	●	●	4	41° - 45°	20	18.3	15	0.5	S12	25.5	KEYV-S12	28	1
VEH200L15.0R10I04S12	●	●	4	41° - 45°	20	18.3	15	1	S12	25.5	KEYV-S12	28	1

* Recommended clamping torque (N-m)
2 pieces per package

● : New
● : Line-up

VEH...

4 flute, roughing - finishing, variable helix and pitch

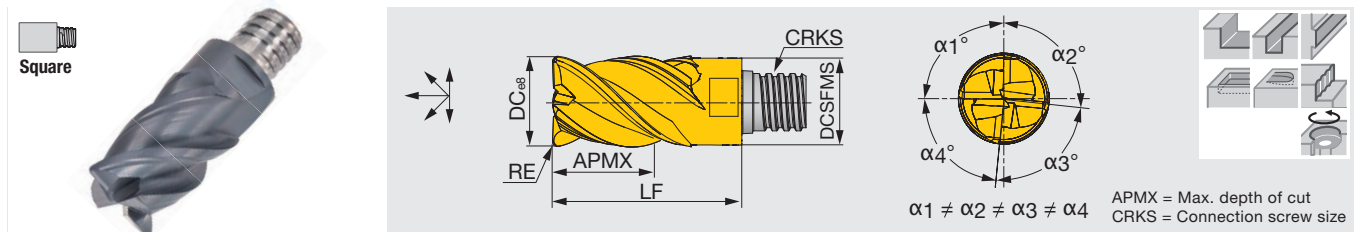

Designation	AH715	NOF	FHA	DC	DCSFMS	APMX	RE	CRKS	LF	Wrench	Torque*
VEH080L12.0R05I04S05	●	4	41° - 45°	8	7.7	12	0.5	S05	18	KEYV-S05	7
VEH080L12.0R10I04S05	●	4	41° - 45°	8	7.7	12	1	S05	18	KEYV-S05	7
VEH100L15.0R05I04S06	●	4	41° - 45°	10	9.7	15	0.5	S06	22	KEYV-S06	10
VEH100L15.0R10I04S06	●	4	41° - 45°	10	9.7	15	1	S06	22	KEYV-S06	10
VEH120L18.0R05I04S08	●	4	41° - 45°	12	11.7	18	0.5	S08	27	KEYV-S08	15
VEH120L18.0R10I04S08	●	4	41° - 45°	12	11.7	18	1	S08	27	KEYV-S08	15
VEH160L24.0R05I04S10	●	4	41° - 45°	16	15.3	24	0.5	S10	33.5	KEYV-S10	28
VEH160L24.0R10I04S10	●	4	41° - 45°	16	15.3	24	1	S10	33.5	KEYV-S10	28
VEH200L30.0R05I04S12	●	4	41° - 45°	20	18.45	30	0.5	S12	41	KEYV-S12	28
VEH200L30.0R10I04S12	●	4	41° - 45°	20	18.45	30	1	S12	41	KEYV-S12	28
VEH250L37.0R05I04S15	●	4	41° - 45°	25	23.9	37	0.5	S15	52.5	KEYV-W20	40
VEH250L37.0R10I04S15	●	4	41° - 45°	25	23.9	37	1	S15	52.5	KEYV-W20	40
VEH320L38.0R00I04S21	●	4	41° - 45°	32	30	38	-	S21	55	KS-24	110
VEH320L38.0R10I04S21	●	4	41° - 45°	32	30	38	1	S21	55	KS-24	110

* Recommended clamping torque (N-m)
VEH080 - VEH160: 2 pieces per package
VEH200 - VEH320: 1 piece per package

● : New
● : Line-up

VEE-04..., VED**-04...**

4 flute, roughing - finishing, general

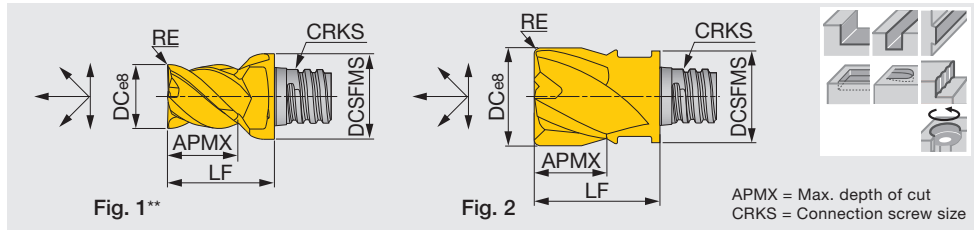

Designation	AH715	AH725	NOF	FHA	DC	DCSFMS	APMX	RE	CRKS	LF	Wrench	Torque*	Fig.
VEE050L04.0R05-04S04		●	4	45°	5	6	4	0.5	S04	8.5	KEYV-S05	4	1
VED060L04.0R05-04S04		●	4	45°	6	5.8	4	0.5	S04	8.5	KEYV-S05	4	2
VEE060L05.0R00-04S05	●	●	4	45°	6	8	5	-	S05	10	KEYV-S05	7	1
VED080L05.0R00-04S05		●	4	45°	8	7.7	5	-	S05	10	KEYV-S05	7	2
VED080L05.0R05-04S05		●	4	30°	8	7.7	5	0.5	S05	10	KEYV-S05	7	2
VED080L05.0R10-04S05		●	4	30°	8	7.7	5	1	S05	10	KEYV-S05	7	2
VED080L05.0R15-04S05		●	4	30°	8	7.7	5	1.5	S05	10	KEYV-S05	7	2
VEE100L07.0R00-04S06		●	4	45°	10	9.7	7	-	S06	13	KEYV-S06	10	2
VED100L07.0R05-04S06		●	4	30°	10	9.7	7	0.5	S06	13	KEYV-S06	10	2
VEE100L07.0R05-04S06		●	4	45°	10	9.7	7	0.5	S06	13	KEYV-S06	10	2
VED100L07.0R10-04S06		●	4	30°	10	9.7	7	1	S06	13	KEYV-S06	10	2
VEE100L07.0R10-04S06		●	4	45°	10	9.7	7	1	S06	13	KEYV-S06	10	2
VEE120L09.0R00-04S08	●	●	4	45°	12	11.7	9	-	S08	16.5	KEYV-S08	15	2
VED120L09.0R05-04S08		●	4	30°	12	11.7	9	0.5	S08	16.5	KEYV-S08	15	2
VEE120L09.0R05-04S08		●	4	45°	12	11.7	9	0.5	S08	16.5	KEYV-S08	15	2
VED120L09.0R10-04S08	●	●	4	30°	12	11.7	9	1	S08	16.5	KEYV-S08	15	2
VEE120L09.0R10-04S08		●	4	45°	12	11.7	9	1	S08	16.5	KEYV-S08	15	2
VEE160L12.0R00-04S10	●	●	4	45°	16	15.3	12	-	S10	20.5	KEYV-S10	28	2
VED160L12.0R05-04S10	●	●	4	30°	16	15.3	12	0.5	S10	20.5	KEYV-S10	28	2
VEE160L12.0R05-04S10		●	4	45°	16	15.3	12	0.5	S10	20.5	KEYV-S10	28	2
VED160L12.0R10-04S10		●	4	30°	16	15.3	12	1	S10	20.5	KEYV-S10	28	2
VEE160L12.0R10-04S10		●	4	45°	16	15.3	12	1	S10	20.5	KEYV-S10	28	2
VED160L12.0R15-04S10		●	4	30°	16	15.3	12	1.5	S10	20.5	KEYV-S10	28	2
VEE160L12.0R15-04S10		●	4	45°	16	15.3	12	1.5	S10	20.5	KEYV-S10	28	2
VED160L12.0R20-04S10		●	4	30°	16	15.3	12	2	S10	20.5	KEYV-S10	28	2
VEE160L12.0R20-04S10		●	4	45°	16	15.3	12	2	S10	20.5	KEYV-S10	28	2
VED160L12.0R30-04S10		●	4	30°	16	15.3	12	3	S10	20.5	KEYV-S10	28	2
VEE160L12.0R30-04S10	●	●	4	45°	16	15.3	12	3	S10	20.5	KEYV-S10	28	2
VED160L12.0R40-04S10		●	4	30°	16	15.3	12	4	S10	20.5	KEYV-S10	28	2
VEE160L12.0R40-04S10		●	4	45°	16	15.3	12	4	S10	20.5	KEYV-S10	28	2
VEE200L15.0R00-04S12		●	4	45°	20	18.3	15	-	S12	25.5	KEYV-S12	28	2
VED200L15.0R05-04S12		●	4	30°	20	18.3	15	0.5	S12	25.5	KEYV-S12	28	2
VED200L15.0R10-04S12	●	●	4	30°	20	18.3	15	1	S12	25.5	KEYV-S12	28	2
VED200L15.0R20-04S12		●	4	30°	20	18.3	15	2	S12	25.5	KEYV-S12	28	2
VED200L15.0R30-04S12		●	4	30°	20	18.3	15	3	S12	25.5	KEYV-S12	28	2

* Recommended clamping torque (N·m)

**Fig. 1: Avoid interference with workpiece when using this cutting head. The shank diameter is larger than the cutter diameter when assembled.
2 pieces per package

● : New
● : Line-up

VEE**-I...

4 flute, roughing - finishing, variable pitch

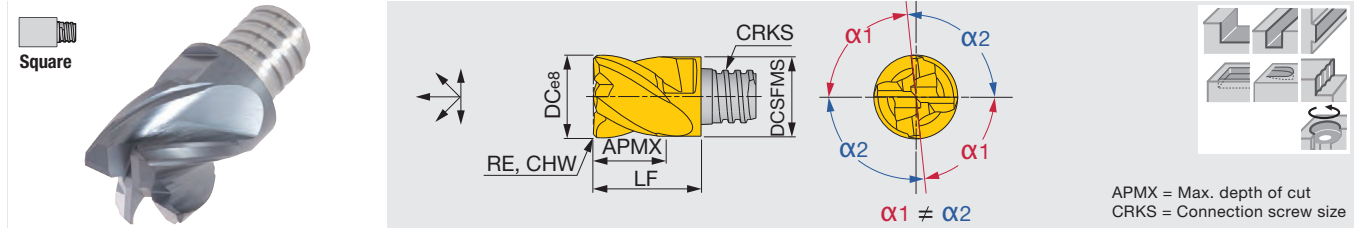

Designation	AH715	AH725	NOF	FHA	DC	DCSFMS	APMX	RE	CHW	CRKS	LF	Wrench	Torque*
VEE080L05.0C30I04S05		●	4	38°	8	7.7	5	-	0.3	S05	10	KEYV-S05	7
VEE100L07.0C40I04S06		●	4	38°	10	9.7	7	-	0.4	S06	13	KEYV-S06	10
VEE120L09.0C50I04S08		●	4	38°	12	11.7	9	-	0.5	S08	16.5	KEYV-S08	15
VEE160L12.0C60I04S10	●	●	4	38°	16	15.3	12	-	0.6	S10	20.5	KEYV-S10	28
VEE200L15.0C60I04S12		●	4	38°	20	18.3	15	-	0.6	S12	25.5	KEYV-S12	28
VEE250L22.0C60I04S15		●	4	38°	25	23.9	22	-	0.6	S15	37	KEYV-W20	40
VEE250L22.0R00I04S15		●	4	38°	25	23.9	22	-	-	S15	37	KEYV-W20	40
VEE250L22.0R05I04S15	●	●	4	38°	25	23.9	22	0.5	-	S15	37	KEYV-W20	40
VEE250L22.0R10I04S15		●	4	38°	25	23.9	22	1	-	S15	37	KEYV-W20	40
VEE250L22.0R20I04S15		●	4	38°	25	23.9	22	2	-	S15	37	KEYV-W20	40
VEE250L22.0R30I04S15		●	4	38°	25	23.9	22	3	-	S15	37	KEYV-W20	40

* Recommended clamping torque (N-m)
VEE080 - VEE200: 2 pieces per package
VEE250: 1 piece per package

● : New
● : Line-up

VEE**-03...

3 flute, roughing - finishing, general, for key way

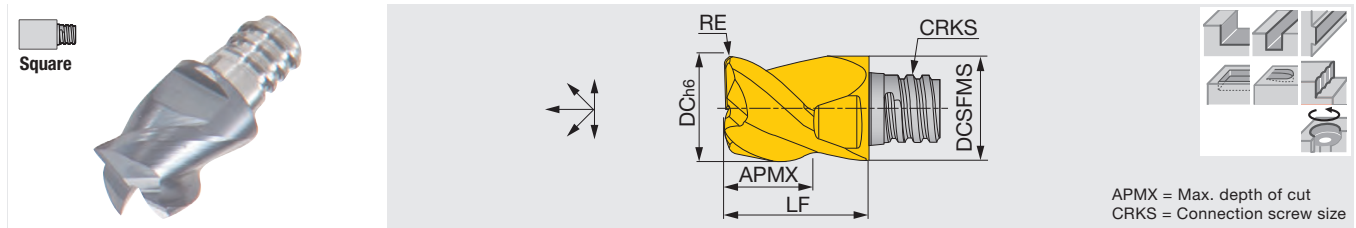

Designation	AH715	AH725	NOF	FHA	DC	DCSFMS	APMX	RE	CRKS	LF	Wrench	Torque*
VEE077L04.0R02-03S05		●	3	38°	7.7	7.7	4	0.2	S05	10	KEYV-S05	7
VEE080L05.0R00-03S05		●	3	45°	8	7.7	5	-	S05	10	KEYV-S05	7
VEE097L05.0R03-03S06		●	3	38°	9.7	9.7	5	0.3	S06	13	KEYV-S06	10
VEE100L07.0R00-03S06		●	3	45°	10	9.7	7	-	S06	13	KEYV-S06	10
VEE117L07.0R03-03S08	●	●	3	38°	11.7	11.7	7	0.3	S08	16.5	KEYV-S08	15
VEE120L09.0R00-03S08		●	3	45°	12	11.7	9	-	S08	16.5	KEYV-S08	15
VEE157L08.0R03-03S10	●	●	3	38°	15.7	15.3	8	0.3	S10	20.5	KEYV-S10	28
VEE197L12.0R04-03S12		●	3	38°	19.7	18.3	12	0.4	S12	25.5	KEYV-S12	28

* Recommended clamping torque (N-m)
2 pieces per package

● : New
● : Line-up

VED**R...

4, 5, 6 flute, roughing, long cutting edge, serrated cutting edge

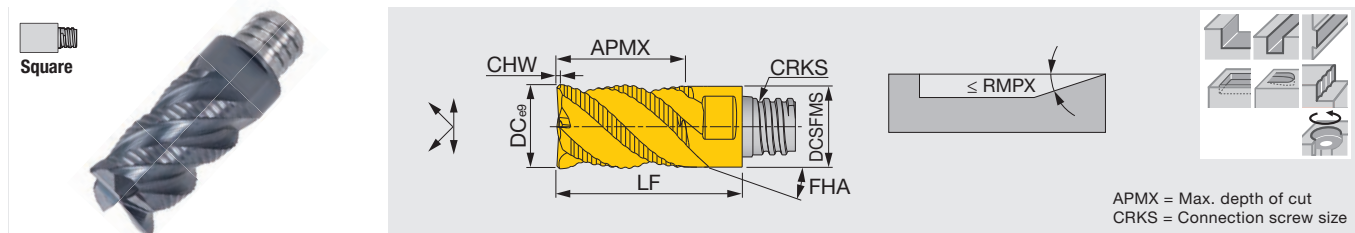

Designation	AH725	NOF	FHA	DC	DCSFMS	APMX	CHW	CRKS	LF	RMPX	Wrench	Torque*
VED080L12.0C25R04S05	●	4	47°	8	7.7	12	0.25	S05	18	5°	KEYV-S05	7
VED100L15.0C30R04S06	●	4	47°	10	9.6	15	0.3	S06	22	5°	KEYV-S06	10
VED120L18.0C35R04S08	●	4	47°	12	11.7	18	0.35	S08	27	5°	KEYV-S08	15
VED160L24.0C40R05S10	●	5	47°	16	15.3	24	0.4	S10	33.5	5°	KEYV-S10	28
VED200L30.0C40R06S12	●	6	47°	20	18.45	30	0.4	S12	41	3°	KEYV-S12	28
VED250L37.0C50I06S15	●	6	47°	25	23.9	37	0.5	S15	52.5	3°	KEYV-W20	40

* Recommended clamping torque (N·m)
VED080 - VED160: 2 pieces per package
VED200, VED250: 1 piece per package

● : New

VED**-07/09...

7, 9 flute, roughing - finishing, long edge, variable helix and pitch, small width of cut

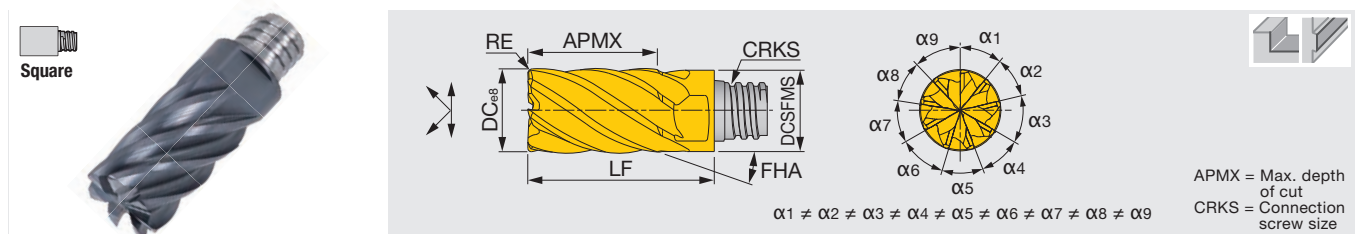

Designation	AH725	NOF	FHA	DC	DCSFMS	APMX	RE	CRKS	LF	Wrench	Torque*
VED080L12.0R05I07S05	●	7	34° - 40°	8	7.7	12	0.5	S05	18	KEYV-S05	7
VED100L15.0R05I07S06	●	7	34° - 40°	10	9.6	15	0.5	S06	22	KEYV-S06	10
VED120L18.0R05I07S08	●	7	34° - 40°	12	11.7	18	0.5	S08	27	KEYV-S08	15
VED160L24.0R08I09S10	●	9	34° - 40°	16	15.3	24	0.8	S10	33.5	KEYV-S10	28
VED200L30.0R10I09S12	●	9	34° - 40°	20	18.45	30	1	S12	41	KEYV-S12	28
VED250L37.0R10I09S15	●	9	34° - 40°	25	23.9	37	1	S15	52.5	KEYV-W20	40

* Recommended clamping torque (N·m)
VED080 - VED160: 2 pieces per package
VED200, VED250: 1 piece per package

● : New

VFM...

6 flute, roughing - finishing, for face milling

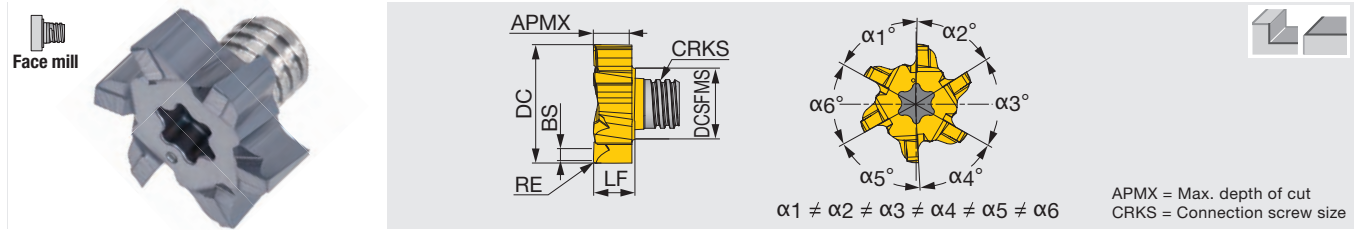

Designation	AH715	NOF	FHA	DC	DCSFMS	APMX	RE	BS	CRKS	LF	Wrench	Torque*
VFM120L03.6R02I06S05	●	6	10°	12	7.7	3.6	0.2	1.2	S05	4.4	KEYV-T20	7
VFM160L04.8R04I06S06	●	6	10°	16	9.7	4.8	0.4	2	S06	5.6	KEYV-T25	10
VFM200L06.0R04I06S08	●	6	10°	20	11.7	6	0.4	2	S08	7	KEYV-T40L	15
VFM250L07.5R04I06S10	●	6	10°	25	15.3	7.5	0.4	2	S10	8.55	KEYV-T50L	28

* Recommended clamping torque (N·m)
2 pieces per package

● : New
● : Line-up

VFX**-04/06...

4, 6 flute, roughing, with coolant hole (2 items do not have coolant hole)

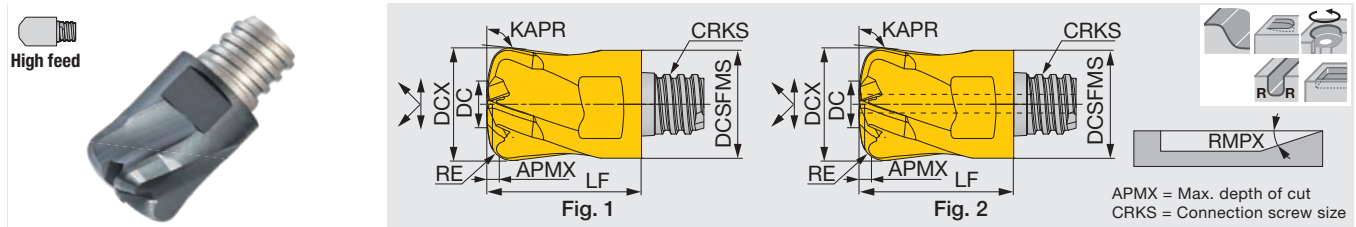

Designation	AH715	AH725	AH750	NOF	FHA	DCX	DC	DCSFMS	APMX	RE	KAPR	CRKS	LF	RMPX	Wrench	Torque*	Fig.
VFX120L0.60R18E04S08	●			4	20°	12	4.8	11.5	0.6	1.8	97°	S08	16.5	5°	KEYV-S08	15	2
VFX120L0.60R18H04S08	●			4	20°	12	4.8	11.5	0.6	1.8	97°	S08	16.5	5°	KEYV-S08	15	1
VFX120L0.65R12E06S08		●		6	20°	12	6.38	11.5	0.65	1.2	97°	S08	16.5	3°	KEYV-S08	15	2
VFX160L0.80R22E04S10	●			4	20°	16	5.6	15.4	0.8	2.2	97°	S10	20.5	5°	KEYV-S10	28	2
VFX160L0.80R22H04S10	●			4	20°	16	5.6	15.4	0.8	2.2	97°	S10	20.5	5°	KEYV-S10	28	1
VFX160L1.05R20E06S10		●		6	20°	16	7	15.4	1.05	2	97°	S10	20.5	3°	KEYV-S10	28	2

We don't recommend slot milling. Also max. ae < 0.4D.
* Recommended clamping torque (N·m)
2 pieces per package

● : New
● : Line-up

VBD**-BG-04..., VBE**-BG-04...

4 flute, roughing - finishing, helix cutting edge

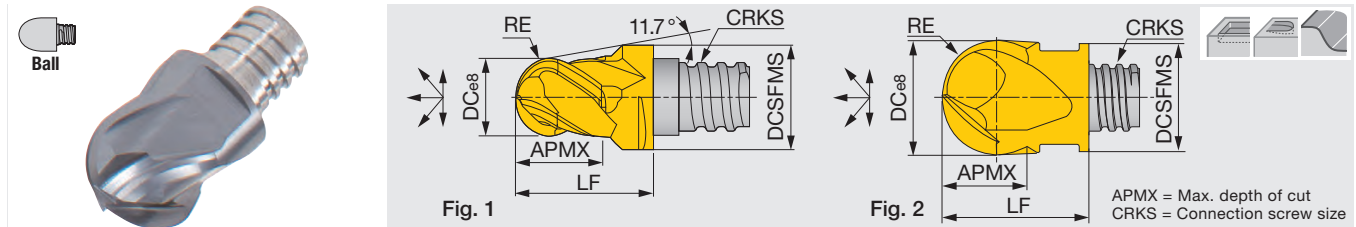

Designation	AH715	AH725	NOF	FHA	DC	DCSFMS	APMX	RE	CRKS	LF	Wrench	Torque*	Fig.
VBE050L04.0-BG-04S04	●		4	38°	5	6	4	2.487 ⁽¹⁾	S04	8.5	KEYV-S05	4	1
VBE060L04.0-BG-04S04	●		4	38°	6	5.8	4	2.987 ⁽¹⁾	S04	8.5	KEYV-S05	4	2
VBE060L05.5-BG-04S05	●		4	38°	6	8	5.5	2.987 ⁽¹⁾	S05	10	KEYV-S05	7	1
VBD080L05.0-BG-04S05	●	●	4	30°	8	7.7	5	3.982 ⁽¹⁾	S05	10	KEYV-S05	7	2
VBD100L07.0-BG-04S06	●	●	4	30°	10	9.7	7	4.982 ⁽¹⁾	S06	13	KEYV-S06	10	2
VBD120L09.0-BG-04S08	●	●	4	30°	12	11.7	9	5.978 ⁽²⁾	S08	16.5	KEYV-S08	15	2
VBD160L12.0-BG-04S10	●	●	4	30°	16	15.3	12	7.978 ⁽²⁾	S10	20.5	KEYV-S10	28	2
VBD200L15.0-BG-04S12	●	●	4	30°	20	18.3	15	9.972 ⁽²⁾	S12	25.5	KEYV-S12	28	2
VBD250L22.0-BG-04S15	●	●	4	30°	25	23.9	22	12.470 ⁽³⁾	S15	37	KEYV-W20	40	2

The tolerance of R: (1) ± 0.01 (2) ± 0.012 (3) ± 0.02

* Recommended clamping torque (N·m)

VBE060/VBD080 ~ VBD200: 2 pieces per package, VBD250: 1 piece per package

● : New
● : Line-up

VBO...

4, 5 flute, semi finishing - finishing, long edge, high productive profiling

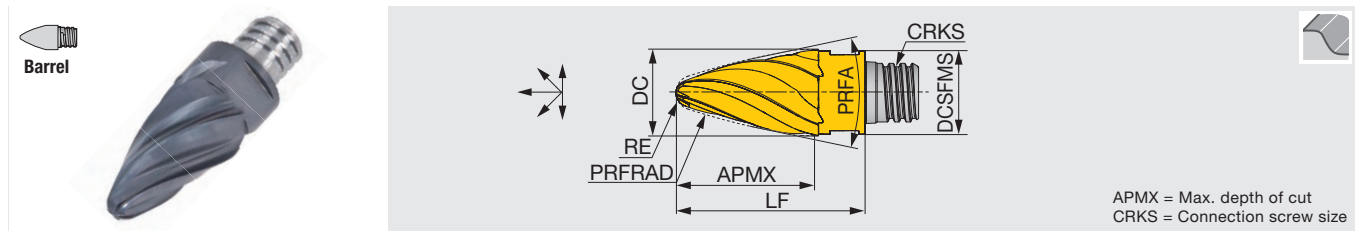

APMX = Max. depth of cut
CRKS = Connection screw size

Designation	AH715	NOF	FHA	DC	DCSFMS	APMX	RE	PRFRAD	PRFA	CRKS	LF	Wrench	Torque*
VBO080L12.0R900-4S05	●	4	30°	8	7.7	12	1	90	33.6°	S05	18	KEYV-S05	7
VBO100L15.0R850-5S06	●	5	30°	10	9.7	15	2	85	27.3°	S06	22	KEYV-S06	10
VBO120L19.0R800-5S08	●	5	30°	12	11.7	19	2	80	29.3°	S08	27	KEYV-S08	15
VBO160L25.0R750-5S10	●	5	30°	16	15.3	25	3	75	26.7°	S10	33.5	KEYV-S10	28

* Recommended clamping torque (N·m)
2 pieces per package

● : New
● : Line-up

VBO...

4 flute, semi finishing - finishing, short edge, high productive profiling

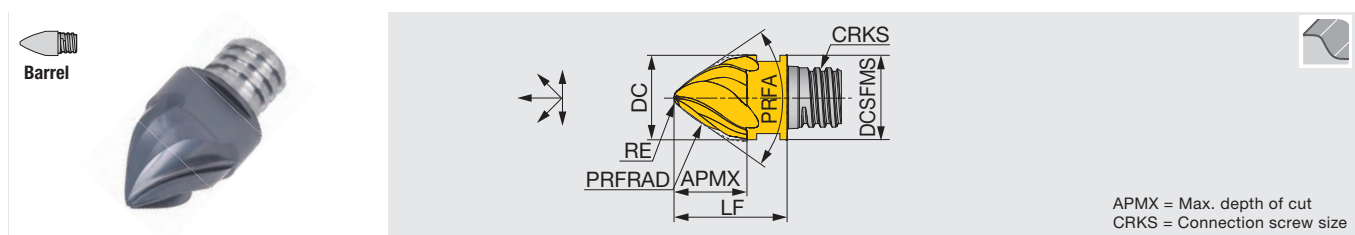

APMX = Max. depth of cut
CRKS = Connection screw size

Designation	AH715	NOF	FHA	DC	DCSFMS	APMX	RE	PRFRAD	PRFA	CRKS	LF	Wrench	Torque*
VBO100L08.0R250-4S06	●	4	30°	10	9.7	8	0.8	25	70.8°	S06	13	KEYV-S06	10
VBO120L09.0R300-4S08	●	4	30°	12	11.7	9	1.2	30	71.6°	S08	16.5	KEYV-S08	15
VBO160L13.0R400-4S10	●	4	30°	16	15.3	13	1.6	40	70.3°	S10	20.5	KEYV-S10	28

* Recommended clamping torque (N·m)
2 pieces per package

● : Line-up

VBN...

6 flute, semi finishing - finishing, high productive profiling

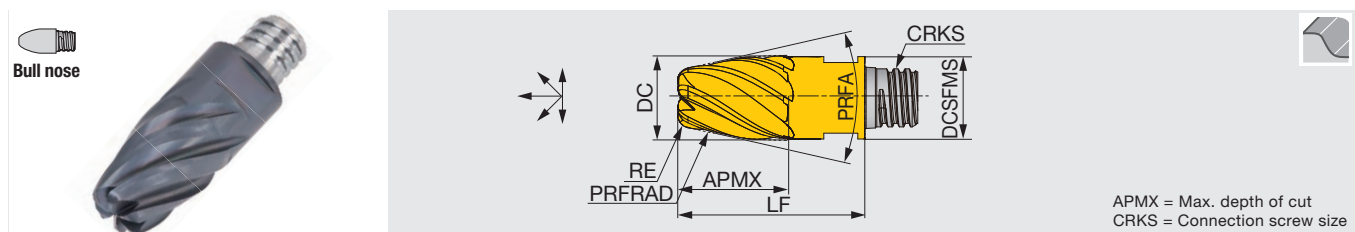

APMX = Max. depth of cut
CRKS = Connection screw size

Designation	AH715	NOF	FHA	DC	DCSFMS	APMX	RE	PRFRAD	PRFA	CRKS	LF	Wrench	Torque*
VBN100L13.0R450-6S06	●	6	35°	10	9.7	13	1.5	45	15.1°	S06	22	KEYV-S06	10
VBN120L15.0R500-6S08	●	6	35°	12	11.7	15	2	50	15.1°	S08	27	KEYV-S08	15
VBN160L18.0R600-6S10	●	6	35°	16	15.3	18	2	60	15.1°	S10	33.5	KEYV-S10	28

* Recommended clamping torque (N·m)
2 pieces per package

● : Line-up

VBL...

6 flute, semi finishing - finishing, high productive profiling

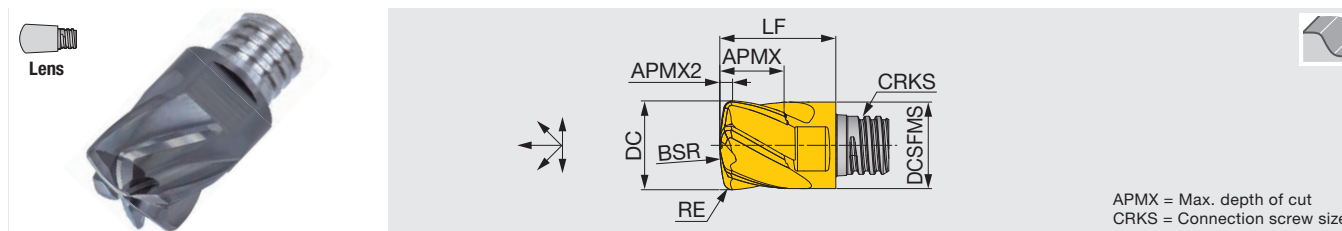

APMX = Max. depth of cut
CRKS = Connection screw size

Designation	AH715	NOF	FHA	DC	DCSFMS	APMX	APMX2	RE	BSR	CRKS	LF	Wrench	Torque*
VBL080L0.90R160-6S05	●	6	30°	8	7.7	5.5	0.9	0.5	16	S05	10	KEYV-S05	7
VBL100L1.40R200-6S06	●	6	30°	10	9.7	7.5	1.42	1	20	S06	13	KEYV-S06	10
VBL120L1.50R240-6S08	●	6	30°	12	11.7	9	1.55	1	24	S08	16.5	KEYV-S08	15
VBL160L1.80R320-6S10	●	6	30°	16	15.3	12	1.8	1	32	S10	20.5	KEYV-S10	28

* Recommended clamping torque (N-m)
2 pieces per package

● : New

VCA**-04/06...

4, 6 flute, chamfering angle: 45°

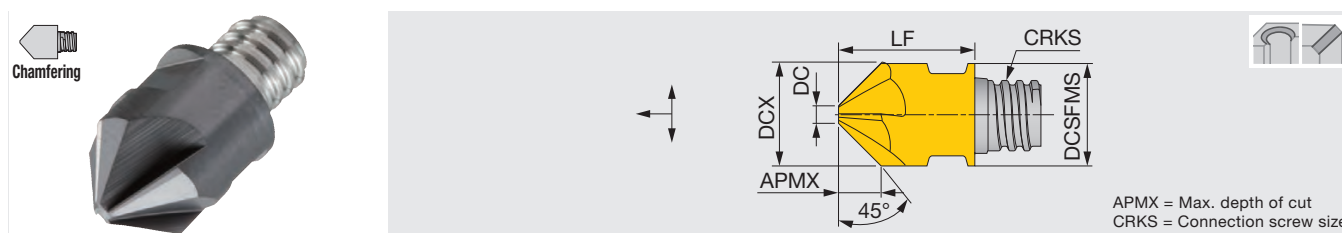

APMX = Max. depth of cut
CRKS = Connection screw size

Designation	AH715	AH725	NOF	FHA	DCX	DCSFMS	APMX	DC	CRKS	LF	Wrench	Torque*
VCA100L04.0A45-04S06	●	●	4	0°	10	10	4	1.95	S06	13	KEYV-S06	10
VCA120L05.0A45-04S08	●	●	4	0°	12	12	5	1.95	S08	16.5	KEYV-S08	15
VCA127L05.3A45-04S08	●	●	4	0°	12.7	12.7	5.3	1.98	S08	16.5	KEYV-S08	15
VCA160L06.5A45-06S10	●	●	6	0°	16	16	6.5	3	S10	20.3	KEYV-S10	28
VCA200L07.5A45-06S12	●	●	6	0°	20	18.3	7.5	5	S12	25.5	KEYV-S12	28

* Recommended clamping torque (N-m)
2 pieces per package

● : New
● : Line-up

VDS...

2 flute, chamfering angle: 45°, helix cutting edge

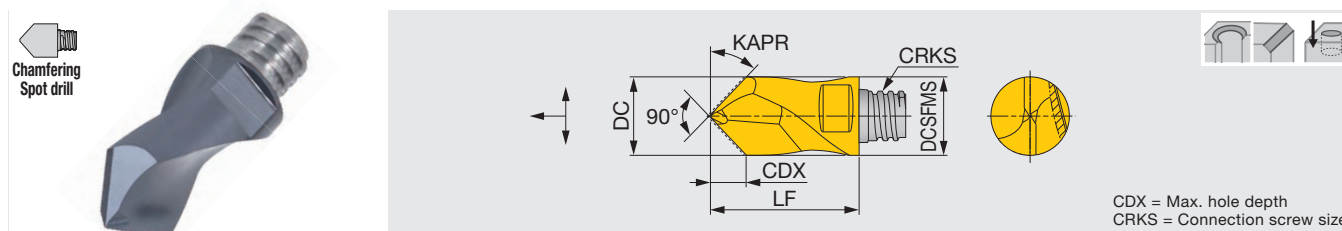

CDX = Max. hole depth
CRKS = Connection screw size

Designation	AH725	NOF	FHA	DC	DCSFMS	CDX	KAPR	CRKS	LF	Wrench	Torque*
VDS080A45-02S05	●	2	10°	8	7.7	3.7	45°	S05	15	KEYV-S05	7
VDS100A45-02S06	●	2	10°	10	9.7	4.4	45°	S06	19	KEYV-S06	10
VDS120A45-02S08	●	2	10°	12	11.7	5.4	45°	S08	23	KEYV-S08	15
VDS160A45-02S10	●	2	10°	16	15.3	7.1	45°	S10	28	KEYV-S10	28

* Recommended clamping torque (N-m)
2 pieces per package

● : New

VDP**-02...

2 flute, A/B type center

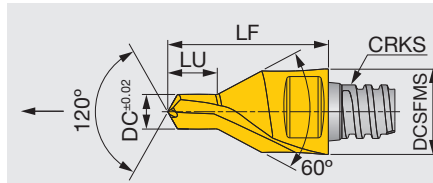

Fig. 1 Type A

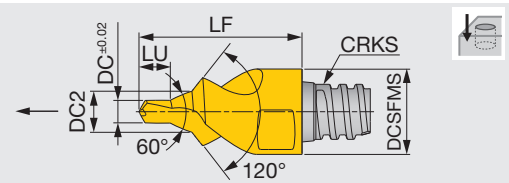

Fig. 2 Type B

CRKS = Connection screw size

Designation	AH725	NOF	FHA	DC±0.02	DC2	DCSFMS	LU	CRKS	LF	Wrench	Torque*	Fig.
VDP107L1.60A30-02S04	●	2	0°	1.07	-	6	1.6	S04	10	KEYV-S05	4	1
VDP165L2.40A30-02S04	●	2	0°	1.65	-	6	2.4	S04	10	KEYV-S05	4	1
VDP207L2.90A30-02S04	●	2	0°	2.07	-	6	2.9	S04	10	KEYV-S05	4	1
VDP328L04.6A30-02S05	●	2	0°	3.28	-	8	4.6	S05	15	KEYV-S05	7	1
VDP412L05.9A30-02S06	●	2	0°	4.12	-	10	5.9	S06	19	KEYV-S06	10	1
VDP513L07.2A30-02S08	●	2	0°	5.13	-	12	7.2	S08	23	KEYV-S08	15	1
VDP646L08.9A30-02S10	●	2	0°	6.46	-	16	8.9	S10	28	KEYV-S10	28	1
VDP324L4.38B30-02S08	●	2	0°	3.24	6.77	12	4.4	S08	23	KEYV-S08	15	2
VDP409L5.60B30-02S08	●	2	0°	4.09	8.56	12.7	5.6	S08	23	KEYV-S08	15	2
VDP509L6.89B30-02S12	●	2	0°	5.09	10.69	18.45	6.9	S12	25.5	KEYV-S12	28	2
VDP641L8.63B30-02S12	●	2	0°	6.41	13.29	20	8.6	S12	25.5	KEYV-S12	28	2

* Recommended clamping torque (N·m)
2 pieces per package

● : New
● : Line-up

SHANKS

VSSD**-W-A...

Straight shank and neck with coolant hole

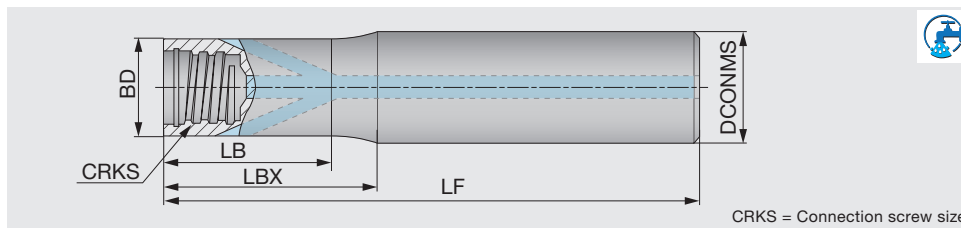

CRKS = Connection screw size

Designation	DCONMS	BD	LF	LBX	LB	CRKS	Shank material
VSSD10L070S06-W-A	10	9.6	70	20	19	S06	Tungsten
VSSD10L090S06-W-A	10	9.6	90	40	39	S06	Tungsten
VSSD10L110S06-W-A	10	9.6	110	60	59	S06	Tungsten
VSSD12L070S08-W-A	12	11.5	70	20	19	S08	Tungsten
VSSD12L090S08-W-A	12	11.5	90	40	39	S08	Tungsten
VSSD12L110S08-W-A	12	11.5	110	60	59	S08	Tungsten
VSSD12L130S08-W-A	12	11.5	130	80	79	S08	Tungsten
VSSD16L070S10-W-A	16	15.2	70	20	18.5	S10	Tungsten
VSSD16L090S10-W-A	16	15.2	90	40	36.5	S10	Tungsten
VSSD16L110S10-W-A	16	15.2	110	60	58.5	S10	Tungsten
VSSD16L130S10-W-A	16	15.2	130	80	78.5	S10	Tungsten
VSSD20L090S12-W-A	20	18.3	90	40	37	S12	Tungsten
VSSD20L130S12-W-A	20	18.3	130	80	77	S12	Tungsten

VSSD...

High rigidity shank

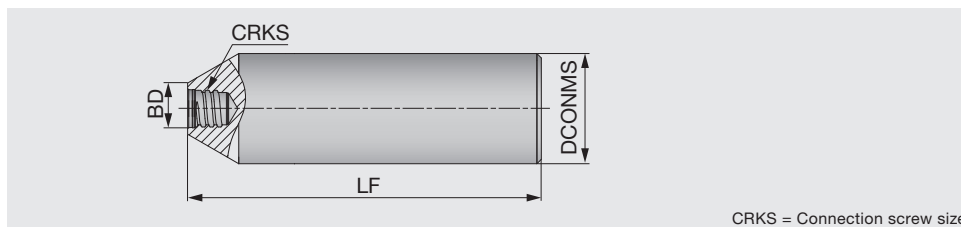

CRKS = Connection screw size

	Designation	DCONMS	BD	LF	CRKS	Shank shape	Shank material
New	VSSD06L050S04-S	6	5.8	50	S04	Cylindrical	Steel
New	VSSD06L060S04-C	6	5.8	60	S04	Cylindrical	Carbide
New	VSSD08L050S04-S	8	5.8	50	S04	Cylindrical	Steel
New	VSSD08L060S04-C	8	5.8	60	S04	Cylindrical	Carbide
	VSSD10L055S05-S	10	7.6	55	S05	Cylindrical	Steel
	VSSD12L065S06-S	12	9.6	65	S06	Cylindrical	Steel
	VSSD16L065S08-S	16	11.6	65	S08	Cylindrical	Steel
	VSSD20L070S10-S	20	15.3	70	S10	Cylindrical	Steel
	VSSD25L075S12-S	25	18.3	75	S12	Cylindrical	Steel
New	VSSD32L100S15-S	32	23.9	100	S15	Cylindrical	Steel
New	VSSD40L100S21-S	40	30	100	S21	Cylindrical	Steel

VSSD...

Straight neck and cylindrical shank

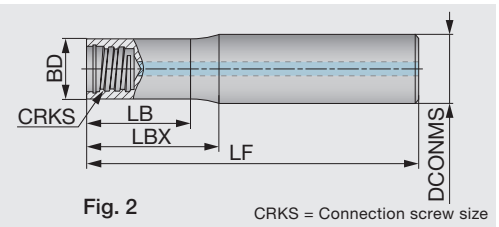
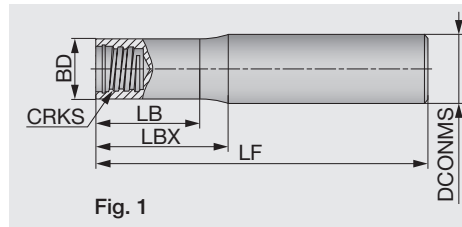

Fig. 1

Fig. 2

CRKS = Connection screw size

Designation	DCONMS	BD	LF	LBX	LB	CRKS	Shank shape	Shank material	Fig.
VSSD08L060S05-S	8	7.6	60	15	12.8	S05	Cylindrical	Steel	1
VSSD08L070S05-C	8	7.6	70	20	19	S05	Cylindrical	Carbide	1
VSSD08L090S05-C	8	7.6	90	40	39	S05	Cylindrical	Carbide	1
VSSD08L110S05-C	8	7.6	110	60	59	S05	Cylindrical	Carbide	1
VSSD10L070S06-C	10	9.6	70	20	18.5	S06	Cylindrical	Carbide	1
VSSD10L075S06-S	10	9.6	75	20	19.4	S06	Cylindrical	Steel	1
VSSD10L090S06-C	10	9.6	90	40	38.5	S06	Cylindrical	Carbide	1
VSSD10L110S06-C	10	9.6	110	60	58.5	S06	Cylindrical	Carbide	1
VSSD10L150S06-C	10	9.6	150	100	98.5	S06	Cylindrical	Carbide	1
VSSD12L070S08-C	12	11.5	70	20	17	S08	Cylindrical	Carbide	1
New VSSD12L070S08-C-A	12	11.5	70	20	17	S08	Cylindrical	Carbide	2
VSSD12L090S08-C	12	11.5	90	40	37	S08	Cylindrical	Carbide	1
VSSD12L090S08-S	12	11.5	90	16	13.6	S08	Cylindrical	Steel	1
New VSSD12L090S08-S-A	12	11.5	90	16	13.6	S08	Cylindrical	Steel	2
New VSSD12L090LS08-C-A	12	11.5	90	40	37	S08	Cylindrical	Carbide	2
New VSSD12L090LS08-S-A	12	11.5	90	40	37	S08	Cylindrical	Steel	2
VSSD12L110S08-C	12	11.5	110	60	58	S08	Cylindrical	Carbide	1
New VSSD12L110S08-C-A	12	11.5	110	60	57	S08	Cylindrical	Carbide	2
VSSD12L130S08-C	12	11.5	130	80	78	S08	Cylindrical	Carbide	1
New VSSD12L130S08-C-A	12	11.5	130	80	77	S08	Cylindrical	Carbide	2
VSSD16L090S10-C	16	15.2	90	40	38	S10	Cylindrical	Carbide	1
New VSSD16L090S10-C-A	16	15.2	90	40	38	S10	Cylindrical	Carbide	2
VSSD16L100S10-S	16	15.2	100	20	18	S10	Cylindrical	Steel	1
New VSSD16L100S10-S-A	16	15.2	100	20	18	S10	Cylindrical	Steel	2
New VSSD16L100LS10-S-A	16	15.2	100	40	38	S10	Cylindrical	Steel	2
VSSD16L110S10-C	16	15.2	110	60	58	S10	Cylindrical	Carbide	1
New VSSD16L110S10-C-A	16	15.2	110	60	58	S10	Cylindrical	Carbide	2
VSSD16L130S10-C	16	15.2	130	80	78	S10	Cylindrical	Carbide	1
New VSSD16L130S10-C-A	16	15.2	130	80	78	S10	Cylindrical	Carbide	2
VSSD16L150S10-C	16	15.2	150	100	98	S10	Cylindrical	Carbide	1
VSSD20L090S12-C	20	18.3	90	40	37	S12	Cylindrical	Carbide	1
VSSD20L120S12-S	20	18.3	120	25	20.5	S12	Cylindrical	Steel	1
VSSD20L130S12-C	20	18.3	130	80	77	S12	Cylindrical	Carbide	1
VSSD20L200S12-C	20	18.3	200	120	117	S12	Cylindrical	Carbide	1
VSSD25L120S15-C	25	23.9	120	60	58	S15	Cylindrical	Carbide	1
VSSD25L135S15-S	25	23.9	135	35	33	S15	Cylindrical	Steel	1
VSSD25L170S15-C	25	23.9	170	100	98	S15	Cylindrical	Carbide	1
VSSD25L250S15-C	25	23.9	250	150	148	S15	Cylindrical	Carbide	1
New VSSD32L100S21-S	32	30	100	35	32	S21	Cylindrical	Steel	1
New VSSD32L150S21-S	32	30	150	54	50	S21	Cylindrical	Steel	1

VSSD**-W...

Straight neck and weldon shank

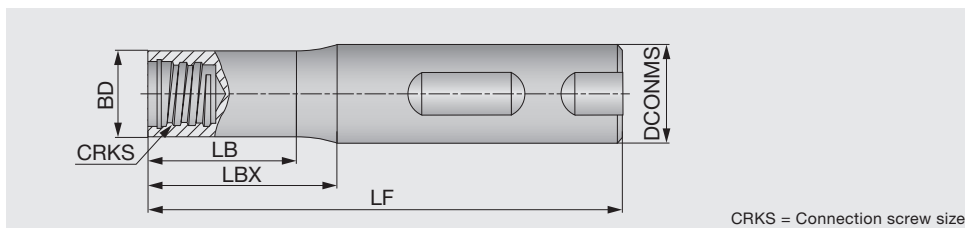

CRKS = Connection screw size

Designation	DCONMS	BD	LF	LBX	LB	CRKS	Shank shape	Shank material
VSSD12L055W05-S	12	7.6	55	3.8	-	S05	Weldon	Steel
VSSD16L065W06-S	16	9.6	65	6	-	S06	Weldon	Steel
VSSD16L065W08-S	16	11.5	65	4	-	S08	Weldon	Steel
VSSD20L070W10-S	20	15.2	70	4	-	S10	Weldon	Steel
VSSD25L075W12-S	25	18.3	75	6	-	S12	Weldon	Steel

VTSD...

Straight shank and taper neck

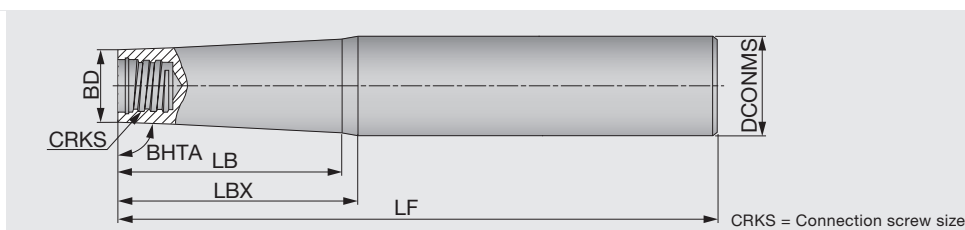

CRKS = Connection screw size

Designation	BHTA	DCONMS	BD	LF	LBX	LB	CRKS	Shank material
New VTSD08L080S04-S	87.4°	8	5.8	80	24	-	S04	Steel
VTSD12L080S05-S	85°	12	7.6	80	25	-	S05	Steel
VTSD12L100S05-S	89°	12	7.6	100	35	29	S05	Steel
VTSD12L110S05-C	89°	12	7.6	110	60	56	S05	Carbide
VTSD12L130S05-C	89°	12	7.6	130	80	77	S05	Carbide
VTSD16L125S06-S	85°	16	9.6	125	34	31	S06	Steel
VTSD16L130S08-C	89°	16	11.5	130	80	76.5	S08	Carbide
VTSD16L140S08-S	85°	16	11.5	140	22	19	S08	Steel
VTSD16L150S05-C	89°	16	7.6	150	100	91	S05	Carbide
VTSD16L150S06-C	89°	16	9.6	150	100	94.5	S06	Carbide
VTSD16L150S08-C	89°	16	11.5	150	100	98	S08	Carbide
VTSD16L160S06-S	89°	16	9.6	160	55	46.5	S06	Steel
VTSD16L170S06-C	89°	16	9.6	170	120	116.5	S06	Carbide
VTSD20L140S10-S	85°	20	15.2	140	27.5	-	S10	Steel
VTSD20L170S08-C	89°	20	11.5	170	120	112	S08	Carbide
VTSD20L170S08-S	89°	20	11.5	170	80	69.5	S08	Steel
VTSD20L170S10-C	89°	20	15.2	170	120	119	S10	Carbide
VTSD20L190S10-C	89°	20	15.2	190	140	-	S10	Carbide
VTSD20L190S10-S	89°	20	15.2	190	80	73	S10	Steel
VTSD20L210S10-C	89°	20	15.2	210	160	-	S10	Carbide
VTSD25L160S12-S	85°	25	18.3	160	40	-	S12	Steel
VTSD25L170S10-S	85°	25	15.2	170	56	-	S10	Steel
VTSD25L180S12-C	89°	25	18.3	180	120	115	S12	Carbide
VTSD25L210S12-S	89°	25	18.3	210	100	94.5	S12	Steel
VTSD25L250S12-C	89°	25	18.3	250	140	136.5	S12	Carbide
VTSD32L155S15-S	85°	32	23.9	155	45	-	S15	Steel
VTSD32L190S12-S	85°	32	18.3	190	80	-	S12	Steel
VTSD32L220S15-S	88°	32	23.9	220	100	-	S15	Steel
VTSD32L250S15-C	89°	32	23.9	250	150	145	S15	Carbide
VTSD32L300S15-C	89°	32	23.9	300	200	198	S15	Carbide
New VTSD40L150S21-S	85°	40	15.2	150	57	-	S21	Steel

VTSD**-W-A...

Straight shank and taper neck with coolant hole

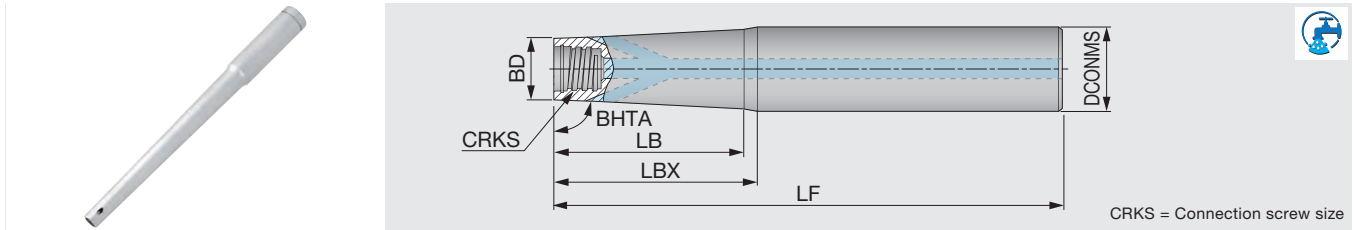

CRKS = Connection screw size

Designation	BHTA	DCONMS	BD	LF	LBX	LB	CRKS	Shank material
VTSD12L110S06-W-A	89°	12	9.6	110	60	59	S06	Tungsten
VTSD16L170S06-W-A	89°	16	9.6	170	120	116	S06	Tungsten

VSC...

Straight shank for VST type slotting heads

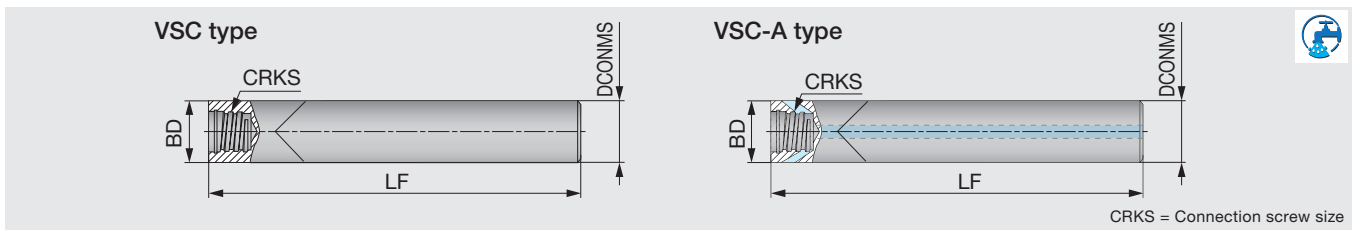

CRKS = Connection screw size

Designation	DCONMS	BD	LF	CRKS	Air hole	Shank material
VSC100L100S06-C	10	10	100	S06	without	Carbide
VSC120L100S08-C-A	12	12	100	S08	with	Carbide

For VSC-C type shank, just VST slotting head is recommended.

If other heads are used on the VSC-C shank, the depth of cut must be smaller than the max. ap in each head.

The VSC-C type shank does not have external clearance, so the shank may interfere with the work piece.

VSTD...

Straight shank for VTB type T-slotting heads

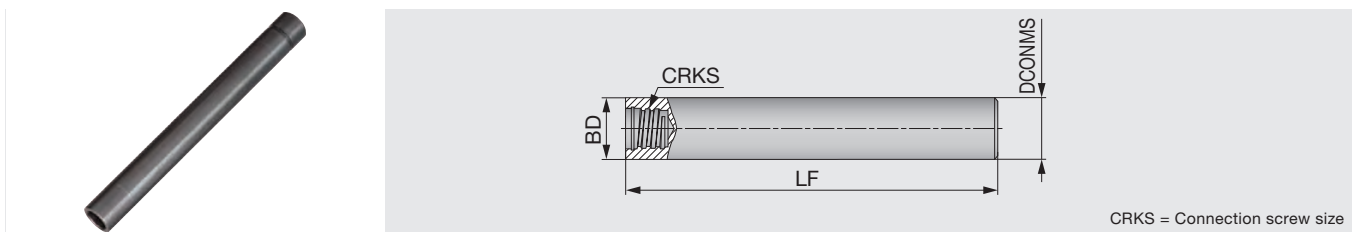

CRKS = Connection screw size

Designation	DCONMS	BD	LF	CRKS	Shank material
New VSTD06L070S04-S	6	6	70	S04	Steel
VSTD08L070S05-S	8	8	70	S05	Steel
VSTD10L080S06-S	10	10	80	S06	Steel
VSTD12L090S08-S	12	12	90	S08	Steel
VSTD16L100S10-S	16	16	100	S10	Steel

For VSTD type shank, just VTB T-slotting head is recommended.

If other heads are used on the VSTD shank, the depth of cut must be smaller than the max. ap in each head.

The VSTD type shank does not have external clearance, so the shank may interfere with the work piece.

VAD**-M...

TungFlex conversion adaptor

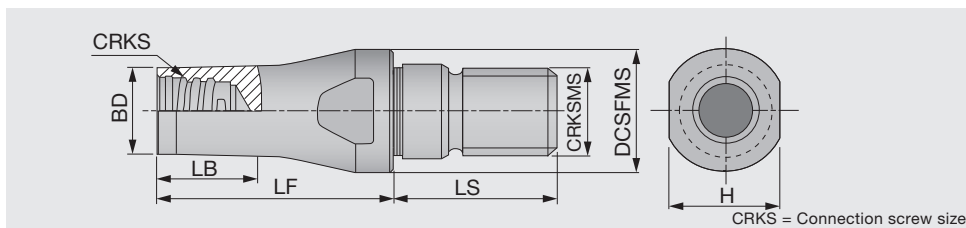

Designation	BD	DCSFMS	LF	LS	LB	CRKS	CRKSMS	H	Shank material
VAD130L016S08-S-M8	11.7	13	16	17.5	6	S08	M8	11	Steel
VAD130L025S08-S-M8	11.7	13	25	17.5	20	S08	M8	11	Steel
VAD180L020S08-S-M10	11.7	18	20	20	12	S08	M10	13	Steel
VAD180L025S08-S-M10	11.7	18	25	20	15	S08	M10	11	Steel
VAD210L020S08-S-M12	11.7	21	20	20	10	S08	M12	12.75	Steel
VAD210L025S08-S-M12	11.7	21	25	20	13	S08	M12	12.75	Steel

VER...

Straight neck with ER11/16 collet

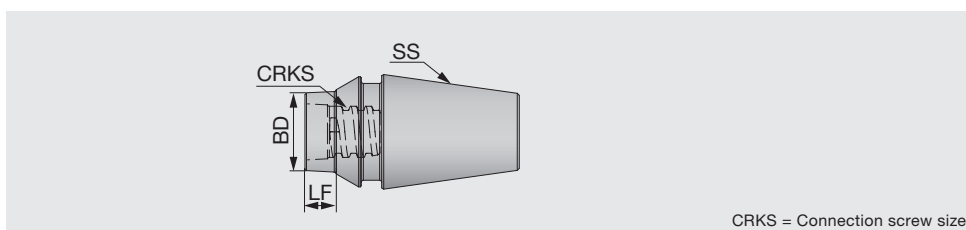

Designation	SS	BD	LF	CRKS	Shank material
New VER11AL006S04-S	ER11	5.8	6	S04	Steel
New VER11AL006S05-S	ER11	7.9	6	S05	Steel
VER11CL006S05-S (1)	ER11	7.92	6	S05	Steel
New VER11AL020S05-S	ER11	7.9	20	S05	Steel
VER11CL020S05-S (1)	ER11	7.92	20	S05	Steel
New VER16AL012S05-S	ER16	7.9	12	S05	Steel
VER16CL012S05-S (1)	ER16	7.92	12	S05	Steel
New VER16AL020S05-S	ER16	7.9	20	S05	Steel
VER16CL020S05-S (1)	ER16	7.92	20	S05	Steel
New VER16AL010S06-S	ER16	9.9	10	S06	Steel
VER16CL010S06-S (1)	ER16	9.92	10	S06	Steel
New VER16AL020S06-S	ER16	9.9	20	S06	Steel
VER16CL020S06-S (1)	ER16	9.92	20	S06	Steel
New VER16AL006S08-S	ER16	11.6	6	S08	Steel
VER16CL006S08-S (1)	ER16	11.6	6	S08	Steel
New VER16AL020S08-S	ER16	11.6	20	S08	Steel
VER16CL020S08-S (1)	ER16	11.6	20	S08	Steel

(1) To be discontinued in 2021

STANDARD CUTTING CONDITIONS

Shoulder milling

VEH, VEE: 3 flutes, VED / VEE: 4 flutes, VEE-I, VED-R

ISO	Workpiece material	Hardness	Cutting speed Vc (m/min)	Feed per tooth: fz (mm/t)									Depth of cut ap (mm)	Width of cut ae (mm)
				Tool diameter: DC (mm)										
				5	6	8	10	12	16	20	25	32		
P	Carbon steel S45C, S55C, etc. C45, C55, etc.	- 300 HB	80 - 180	0.03 - 0.07	0.03 - 0.07	0.05 - 0.09	0.07 - 0.12	0.08 - 0.13	0.09 - 0.15	0.1 - 0.17	0.1 - 0.17	0.1 - 0.18	0.6 x DC	0.25 x DC
	Alloy steel SCM440, SCr420, etc. 42CrMo4, 20Cr4, etc.	- 300 HB	60 - 140	0.03 - 0.07	0.03 - 0.07	0.05 - 0.09	0.07 - 0.12	0.08 - 0.13	0.09 - 0.15	0.1 - 0.17	0.1 - 0.17	0.1 - 0.18	0.6 x DC	0.25 x DC
	Prehardened steel PX5, NAK80, etc.	30 - 40 HRC	60 - 120	0.03 - 0.07	0.03 - 0.07	0.05 - 0.09	0.07 - 0.12	0.08 - 0.13	0.09 - 0.15	0.1 - 0.17	0.1 - 0.17	0.1 - 0.18	0.6 x DC	0.25 x DC
M	Stainless steel SUS304, SUS316, etc. X5CrNi18-9, X5CrNiMo17-12-2, etc.	- 200 HB	40 - 100	0.03 - 0.07	0.03 - 0.07	0.05 - 0.09	0.07 - 0.12	0.08 - 0.13	0.09 - 0.15	0.1 - 0.17	0.1 - 0.17	0.1 - 0.18	0.6 x DC	0.25 x DC
K	Grey cast iron FC250, FC300, etc. 250, 300, etc., GG250, GG300, etc.	150 - 250 HB	80 - 200	0.03 - 0.07	0.03 - 0.07	0.05 - 0.09	0.07 - 0.12	0.08 - 0.13	0.09 - 0.15	0.1 - 0.17	0.1 - 0.17	0.1 - 0.18	0.6 x DC	0.25 x DC
	Ductile cast iron FCD450, etc. 450-10S, etc., GGG450, etc.	150 - 250 HB	80 - 200	0.03 - 0.07	0.03 - 0.07	0.05 - 0.09	0.07 - 0.12	0.08 - 0.13	0.09 - 0.15	0.1 - 0.17	0.1 - 0.17	0.1 - 0.18	0.6 x DC	0.25 x DC
N	Aluminium alloys Si < 13%	-	200 - 700	0.03 - 0.07	0.03 - 0.07	0.05 - 0.09	0.07 - 0.12	0.08 - 0.13	0.09 - 0.15	0.1 - 0.17	0.1 - 0.17	0.1 - 0.18	0.6 x DC	0.25 x DC
	Aluminium alloys Si ≥ 13%	-	100 - 300	0.03 - 0.07	0.03 - 0.07	0.05 - 0.09	0.07 - 0.12	0.08 - 0.13	0.09 - 0.15	0.1 - 0.17	0.1 - 0.17	0.1 - 0.18	0.6 x DC	0.25 x DC
S	Titanium alloys Ti-6Al-4V, etc.	-	40 - 80	0.03 - 0.07	0.03 - 0.07	0.05 - 0.09	0.07 - 0.12	0.08 - 0.13	0.09 - 0.15	0.1 - 0.17	0.1 - 0.17	0.1 - 0.18	0.6 x DC	0.25 x DC
	Heat-resistant alloys Inconel 718, etc.	-	20 - 40	0.03 - 0.07	0.03 - 0.07	0.05 - 0.09	0.07 - 0.12	0.08 - 0.13	0.09 - 0.15	0.1 - 0.17	0.1 - 0.17	0.1 - 0.18	0.6 x DC	0.25 x DC
H	Hardened steel SKD6, SKT4, etc. 55NiCrMoV7, etc.	40 - 50 HRC	40 - 80	0.03 - 0.07	0.03 - 0.07	0.05 - 0.09	0.07 - 0.12	0.08 - 0.13	0.09 - 0.15	0.1 - 0.17	0.1 - 0.17	0.1 - 0.18	0.6 x DC	0.25 x DC
	Hardened steel SKD11, SKH51, etc. HS6-5-2, etc.	50 - 60 HRC	20 - 60	0.03 - 0.07	0.03 - 0.07	0.05 - 0.09	0.07 - 0.12	0.08 - 0.13	0.09 - 0.15	0.1 - 0.17	0.1 - 0.17	0.1 - 0.18	0.6 x DC	0.25 x DC

Milling

VED: 7, 9 flutes

ISO	Workpiece material	Hardness	Cutting speed Vc (m/min)	Feed per tooth: fz (mm/t)						Depth of cut ap (mm)	Width of cut ae (mm)
				Tool diameter: DC (mm)							
				8	10	12	16	20	25		
S	Titanium alloys Ti-6Al-4V, etc.	-	60 - 120	0.05 - 0.09	0.07 - 0.12	0.08 - 0.13	0.09 - 0.15	0.1 - 0.17	0.1 - 0.17	0.6 x DC	0.02 x DC
	Heat-resistant alloys Inconel 718, etc.	-	30 - 60	0.05 - 0.09	0.07 - 0.12	0.08 - 0.13	0.09 - 0.15	0.1 - 0.17	0.1 - 0.17	0.6 x DC	0.02 x DC
H	Hardened steel SKD6, SKT4, etc. 55NiCrMoV7, etc.	40 - 50 HRC	80 - 160	0.05 - 0.09	0.07 - 0.12	0.08 - 0.13	0.09 - 0.15	0.1 - 0.17	0.1 - 0.17	0.6 x DC	0.02 x DC
	Hardened steel SKD11, SKH51, etc. HS6-5-2, etc.	50 - 60 HRC	40 - 90	0.05 - 0.09	0.07 - 0.12	0.08 - 0.13	0.09 - 0.15	0.1 - 0.17	0.1 - 0.17	0.6 x DC	0.02 x DC

Slotting

VEH, VEE: 3 flutes, VED/VEE: 4 flutes, VEE-I,

ISO	Workpiece material	Hardness	Cutting speed V_c (m/min)	Feed per tooth: f_z (mm/t)									Depth of cut a_p (mm)
				Tool diameter: DC (mm)									
				5	6	8	10	12	16	20	25	32	
P	Carbon steel S45C, S55C, etc. C45, C55, etc.	- 300 HB	50 - 70	0.03 - 0.04	0.03 - 0.04	0.03 - 0.04	0.04 - 0.05	0.05 - 0.06	0.06 - 0.08	0.07 - 0.1	0.07 - 0.1	0.07 - 0.1	0.5 x DC
	Alloy steel SCM440, SCR420, etc. 42CrMo4, 20Cr4, etc.	- 300 HB	40 - 80	0.03 - 0.04	0.03 - 0.04	0.03 - 0.04	0.04 - 0.05	0.05 - 0.06	0.06 - 0.08	0.07 - 0.1	0.07 - 0.1	0.07 - 0.1	0.5 x DC
	Prehardened steel PX5, NAK80, etc.	30 - 40 HRC	40 - 70	0.03 - 0.04	0.03 - 0.04	0.03 - 0.04	0.04 - 0.05	0.05 - 0.06	0.06 - 0.08	0.07 - 0.1	0.07 - 0.1	0.07 - 0.1	0.5 x DC
M	Stainless steel SUS304, SUS316, etc. X5CrNi18-9, X5CrNiMo17-12-2, etc.	- 200 HB	30 - 60	0.03 - 0.04	0.03 - 0.04	0.03 - 0.04	0.04 - 0.05	0.05 - 0.06	0.06 - 0.08	0.07 - 0.1	0.07 - 0.1	0.07 - 0.1	0.5 x DC
K	Grey cast iron FC250, FC300, etc. 250, 300, etc., GG250, GG300, etc.	150 - 250 HB	50 - 120	0.03 - 0.04	0.03 - 0.04	0.03 - 0.04	0.04 - 0.05	0.05 - 0.06	0.06 - 0.08	0.07 - 0.1	0.07 - 0.1	0.07 - 0.1	0.5 x DC
	Ductile cast iron FCD450, etc. 450-10S, etc., GGG450, etc.	150 - 250 HB	50 - 120	0.03 - 0.04	0.03 - 0.04	0.03 - 0.04	0.04 - 0.05	0.05 - 0.06	0.06 - 0.08	0.07 - 0.1	0.07 - 0.1	0.07 - 0.1	0.5 x DC
N	Aluminium alloys Si < 13%	-	130 - 400	0.03 - 0.04	0.03 - 0.04	0.03 - 0.04	0.04 - 0.05	0.05 - 0.06	0.06 - 0.08	0.07 - 0.1	0.07 - 0.1	0.07 - 0.1	0.5 x DC
	Aluminium alloys Si ≥ 13%	-	70 - 200	0.03 - 0.04	0.03 - 0.04	0.03 - 0.04	0.04 - 0.05	0.05 - 0.06	0.06 - 0.08	0.07 - 0.1	0.07 - 0.1	0.07 - 0.1	0.5 x DC
S	Titanium alloys Ti-6Al-4V, etc.	-	20 - 40	0.03 - 0.04	0.03 - 0.04	0.03 - 0.04	0.04 - 0.05	0.05 - 0.06	0.06 - 0.08	0.07 - 0.1	0.07 - 0.1	0.07 - 0.1	0.5 x DC
	Heat-resistant alloys Inconel 718, etc.	-	10 - 20	0.03 - 0.04	0.03 - 0.04	0.03 - 0.04	0.04 - 0.05	0.05 - 0.06	0.06 - 0.08	0.07 - 0.1	0.07 - 0.1	0.07 - 0.1	0.5 x DC
H	Hardened steel SKD6, SKT4, etc. 55NiCrMoV7, etc.	40 - 50 HRC	25 - 60	0.03 - 0.04	0.03 - 0.04	0.03 - 0.04	0.04 - 0.05	0.05 - 0.06	0.06 - 0.08	0.07 - 0.1	0.07 - 0.1	0.07 - 0.1	0.5 x DC
	Hardened steel SKD11, SKH51, etc. HS6-5-2, etc.	50 - 60 HRC	10 - 30	0.03 - 0.04	0.03 - 0.04	0.03 - 0.04	0.04 - 0.05	0.05 - 0.06	0.06 - 0.08	0.07 - 0.1	0.07 - 0.1	0.07 - 0.1	0.5 x DC

Face milling

VFM

ISO	Workpiece material	Hardness	Cutting speed V _c (m/min)	Feed per tooth: fz (mm/t)				Depth of cut ap (mm)	Width of cut ae (mm)
				Tool diameter: DC (mm)					
				12	16	20	25		
P	Carbon steel S45C, S55C, etc. C45, C55, etc.	- 300 HB	80 - 180	0.08 - 0.13	0.09 - 0.15	0.1 - 0.17	0.1 - 0.17	1	0.7 x DC
	Alloy steel SCM440, SCr420, etc. 42CrMo4, 20Cr4, etc.	- 300 HB	60 - 140	0.08 - 0.13	0.09 - 0.15	0.1 - 0.17	0.1 - 0.17	1	0.7 x DC
	Prehardened steel PX5, NAK80, etc.	30 - 40 HRC	60 - 120	0.08 - 0.13	0.09 - 0.15	0.1 - 0.17	0.1 - 0.17	1	0.7 x DC
M	Stainless steel SUS304, SUS316, etc. X5CrNi18-9, X5CrNiMo17-12-2, etc.	- 200 HB	40 - 100	0.08 - 0.13	0.09 - 0.15	0.1 - 0.17	0.1 - 0.17	1	0.7 x DC
K	Grey cast iron FC250, FC300, etc. 250, 300, etc., GG250, GG300, etc.	150 - 250 HB	80 - 200	0.08 - 0.13	0.09 - 0.15	0.1 - 0.17	0.1 - 0.17	1	0.7 x DC
	Ductile cast iron FCD450, etc. 450-10S, etc., GGG450, etc.	150 - 250 HB	80 - 200	0.08 - 0.13	0.09 - 0.15	0.1 - 0.17	0.1 - 0.17	1	0.7 x DC
N	Aluminium alloys Si < 13%	-	200 - 700	0.08 - 0.13	0.09 - 0.15	0.1 - 0.17	0.1 - 0.17	1	0.7 x DC
	Aluminium alloys Si ≥ 13%	-	100 - 300	0.08 - 0.13	0.09 - 0.15	0.1 - 0.17	0.1 - 0.17	1	0.7 x DC
S	Titanium alloys Ti-6Al-4V, etc.	-	40 - 80	0.08 - 0.13	0.09 - 0.15	0.1 - 0.17	0.1 - 0.17	1	0.7 x DC
	Heat-resistant alloys Inconel 718, etc.	-	20 - 40	0.08 - 0.13	0.09 - 0.15	0.1 - 0.17	0.1 - 0.17	1	0.7 x DC
H	Hardened steel SKD6, SKT4, etc. 55NiCrMoV7, etc.	40 - 50 HRC	40 - 80	0.08 - 0.13	0.09 - 0.15	0.1 - 0.17	0.1 - 0.17	1	0.7 x DC
	Hardened steel SKD11, SKH51, etc. HS6-5-2, etc.	50 - 60 HRC	20 - 60	0.08 - 0.13	0.09 - 0.15	0.1 - 0.17	0.1 - 0.17	1	0.7 x DC

High feed milling

VFX: 4, 6 flutes

ISO	Workpiece material	Hardness	Cutting speed V _c (m/min)	ø10		ø12		ø16		ø20		Width of cut ae (mm)
				Feed per tooth	Depth of cut	Feed per tooth	Depth of cut	Feed per tooth	Depth of cut	Feed per tooth	Depth of cut	
				fz (mm/t)	ap (mm)	fz (mm/t)	ap (mm)	fz (mm/t)	ap (mm)	fz (mm/t)	ap (mm)	
P	Carbon steel S45C, S55C, etc. C45, C55, etc.	- 300 HB	100 - 200	0.3 - 0.7	0.5	0.4 - 0.8	0.5	0.5 - 0.9	0.75	0.6 - 1	1	0.6 x DC
	Alloy steel SCM440, SCr420, etc. 42CrMo4, 20Cr4, etc.	- 300 HB	80 - 180	0.2 - 0.6	0.5	0.3 - 0.7	0.5	0.4 - 0.8	0.75	0.5 - 0.9	1	0.6 x DC
	Prehardened steel PX5, NAK80, etc.	30 - 40 HRC	80 - 160	0.2 - 0.5	0.4	0.2 - 0.5	0.4	0.3 - 0.6	0.5	0.3 - 0.6	0.75	0.6 x DC
M	Stainless steel SUS304, SUS316, etc. X5CrNi18-9, X5CrNiMo17-12-2, etc.	- 200 HB	60 - 100	0.2 - 0.6	0.4	0.2 - 0.6	0.4	0.3 - 0.7	0.5	0.3 - 0.7	0.75	0.6 x DC
K	Grey cast iron FC250, FC300, etc. 250, 300, etc., GG250, GG300, etc.	150 - 250 HB	100 - 220	0.3 - 0.7	0.5	0.4 - 0.8	0.75	0.5 - 0.9	0.75	0.6 - 1	1	0.6 x DC
	Ductile cast iron FCD450, etc. 450-10S, etc., GGG450, etc.	150 - 250 HB	100 - 220	0.2 - 0.6	0.5	0.3 - 0.7	0.75	0.4 - 0.8	0.75	0.5 - 0.9	1	0.6 x DC
S	Titanium alloys Ti-6Al-4V, etc.	-	40 - 80	0.2 - 0.5	0.4	0.2 - 0.5	0.4	0.2 - 0.6	0.5	0.2 - 0.6	0.5	0.25 x DC
	Heat-resistant alloys Inconel 718, etc.	-	20 - 40	0.1 - 0.3	0.3	0.1 - 0.3	0.3	0.1 - 0.3	0.4	0.1 - 0.3	0.4	0.25 x DC
H	Hardened steel SKD6, SKT4, etc. 55NiCrMoV7, etc.	40 - 50 HRC	40 - 80	0.2 - 0.4	0.3	0.2 - 0.4	0.3	0.3 - 0.5	0.4	0.3 - 0.5	0.4	0.45 x DC
	Hardened steel SKD11, SKH51, etc. HS6-5-2, etc.	50 - 60 HRC	20 - 60	0.1 - 0.2	0.2	0.1 - 0.2	0.2	0.1 - 0.3	0.3	0.1 - 0.3	0.3	0.25 x DC

Please note that the feed per tooth should not exceed the maximum feed per tooth for each product.

Profiling for roughing

VBD-BG, VBE-BGA

ISO	Workpiece material	Hardness	Cutting speed V_c (m/min)	Feed per tooth: f_z (mm/t)								Depth of cut a_p (mm)	Pick feed P_f (mm)
				Tool diameter: DC (mm)									
				5	6	8	10	12	16	20	25		
P	Carbon steel S45C, S55C, etc. C45, C55, etc.	- 300 HB	100 - 200	0.03 - 0.07	0.03 - 0.07	0.04 - 0.08	0.05 - 0.1	0.06 - 0.11	0.07 - 0.13	0.08 - 0.15	0.08 - 0.15	0.3 x DC	0.4 x DC
	Alloy steel SCM440, SCr420, etc. 42CrMo4, 20Cr4, etc.	- 300 HB	80 - 180	0.03 - 0.07	0.03 - 0.07	0.04 - 0.08	0.05 - 0.1	0.06 - 0.11	0.07 - 0.13	0.08 - 0.15	0.08 - 0.15	0.3 x DC	0.4 x DC
	Prehardened steel PX5, NAK80, etc.	30 - 40 HRC	80 - 160	0.03 - 0.07	0.03 - 0.07	0.04 - 0.08	0.05 - 0.1	0.06 - 0.11	0.07 - 0.13	0.08 - 0.15	0.08 - 0.15	0.3 x DC	0.4 x DC
M	Stainless steel SUS304, SUS316, etc. X5CrNi18-9, X5CrNiMo17-12-2, etc.	- 200 HB	60 - 100	0.03 - 0.07	0.03 - 0.07	0.04 - 0.08	0.05 - 0.1	0.06 - 0.11	0.07 - 0.13	0.08 - 0.15	0.08 - 0.15	0.3 x DC	0.4 x DC
K	Grey cast iron FC250, FC300, etc. 250, 300, etc., GG250, GG300, etc.	150 - 250 HB	100 - 220	0.03 - 0.07	0.03 - 0.07	0.04 - 0.08	0.05 - 0.1	0.06 - 0.11	0.07 - 0.13	0.08 - 0.15	0.08 - 0.15	0.3 x DC	0.4 x DC
	Ductile cast iron FCD450, etc. 450-10S, etc., GGG450, etc.	150 - 250 HB	100 - 220	0.03 - 0.07	0.03 - 0.07	0.04 - 0.08	0.05 - 0.1	0.06 - 0.11	0.07 - 0.13	0.08 - 0.15	0.08 - 0.15	0.3 x DC	0.4 x DC
N	Aluminium alloys Si < 13%	-	200 - 700	0.03 - 0.07	0.03 - 0.07	0.04 - 0.08	0.05 - 0.1	0.06 - 0.11	0.07 - 0.13	0.08 - 0.15	0.08 - 0.15	0.3 x DC	0.4 x DC
	Aluminium alloys Si ≥ 13%	-	100 - 300	0.03 - 0.07	0.03 - 0.07	0.04 - 0.08	0.05 - 0.1	0.06 - 0.11	0.07 - 0.13	0.08 - 0.15	0.08 - 0.15	0.3 x DC	0.4 x DC
S	Titanium alloys Ti-6Al-4V, etc.	-	40 - 80	0.03 - 0.07	0.03 - 0.07	0.04 - 0.08	0.05 - 0.1	0.06 - 0.11	0.07 - 0.13	0.08 - 0.15	0.08 - 0.15	0.3 x DC	0.2 x DC
	Heat-resistant alloys Inconel 718, etc.	-	20 - 40	0.03 - 0.07	0.03 - 0.07	0.04 - 0.08	0.05 - 0.1	0.06 - 0.11	0.07 - 0.13	0.08 - 0.15	0.08 - 0.15	0.3 x DC	0.2 x DC
H	Hardened steel SKD6, SKT4, etc. 55NiCrMoV7, etc.	40 - 50 HRC	40 - 80	0.03 - 0.07	0.03 - 0.07	0.04 - 0.08	0.05 - 0.1	0.06 - 0.11	0.07 - 0.13	0.08 - 0.15	0.08 - 0.15	0.3 x DC	0.2 x DC
	Hardened steel SKD11, SKH51, etc. HS6-5-2, etc.	50 - 60 HRC	20 - 60	0.03 - 0.07	0.03 - 0.07	0.04 - 0.08	0.05 - 0.1	0.06 - 0.11	0.07 - 0.13	0.08 - 0.15	0.08 - 0.15	0.3 x DC	0.2 x DC

Profiling for semi-finishing and finishing

VBD-BG, VBE-BGA

ISO	Workpiece material	Hardness	Cutting speed V_c (m/min)	Feed per tooth: f_z (mm/t)								Depth of cut a_p (mm)	Pick feed P_f (mm)
				Tool diameter: DC (mm)									
				5	6	8	10	12	16	20	25		
P	Carbon steel S45C, S55C, etc. C45, C55, etc.	- 300 HB	120 - 250	0.04 - 0.09	0.04 - 0.09	0.06 - 0.11	0.07 - 0.12	0.08 - 0.13	0.09 - 0.16	0.1 - 0.18	0.1 - 0.18	0.1 x DC	0.15 x DC
	Alloy steel SCM440, SCr420, etc. 42CrMo4, 20Cr4, etc.	- 300 HB	100 - 220	0.04 - 0.09	0.04 - 0.09	0.06 - 0.11	0.07 - 0.12	0.08 - 0.13	0.09 - 0.16	0.1 - 0.18	0.1 - 0.18	0.1 x DC	0.15 x DC
	Prehardened steel PX5, NAK80, etc.	30 - 40 HRC	100 - 200	0.04 - 0.09	0.04 - 0.09	0.06 - 0.11	0.07 - 0.12	0.08 - 0.13	0.09 - 0.16	0.1 - 0.18	0.1 - 0.18	0.1 x DC	0.15 x DC
M	Stainless steel SUS304, SUS316, etc. X5CrNi18-9, X5CrNiMo17-12-2, etc.	- 200 HB	80 - 120	0.04 - 0.09	0.04 - 0.09	0.06 - 0.11	0.07 - 0.12	0.08 - 0.13	0.09 - 0.16	0.1 - 0.18	0.1 - 0.18	0.1 x DC	0.15 x DC
K	Grey cast iron FC250, FC300, etc. 250, 300, etc., GG250, GG300, etc.	150 - 250 HB	120 - 280	0.04 - 0.09	0.04 - 0.09	0.06 - 0.11	0.07 - 0.12	0.08 - 0.13	0.09 - 0.16	0.1 - 0.18	0.1 - 0.18	0.1 x DC	0.15 x DC
	Ductile cast iron FCD450, etc. 450-10S, etc., GGG450, etc.	150 - 250 HB	120 - 280	0.04 - 0.09	0.04 - 0.09	0.06 - 0.11	0.07 - 0.12	0.08 - 0.13	0.09 - 0.16	0.1 - 0.18	0.1 - 0.18	0.1 x DC	0.15 x DC
N	Aluminium alloys Si < 13%	-	300 - 1000	0.04 - 0.09	0.04 - 0.09	0.06 - 0.11	0.07 - 0.12	0.08 - 0.13	0.09 - 0.16	0.1 - 0.18	0.1 - 0.18	0.1 x DC	0.15 x DC
	Aluminium alloys Si ≥ 13%	-	150 - 400	0.04 - 0.09	0.04 - 0.09	0.06 - 0.11	0.07 - 0.12	0.08 - 0.13	0.09 - 0.16	0.1 - 0.18	0.1 - 0.18	0.1 x DC	0.15 x DC
S	Titanium alloys Ti-6Al-4V, etc.	-	50 - 100	0.04 - 0.09	0.04 - 0.09	0.06 - 0.11	0.07 - 0.12	0.08 - 0.13	0.09 - 0.16	0.1 - 0.18	0.1 - 0.18	0.08 x DC	0.1 x DC
	Heat-resistant alloys Inconel 718, etc.	-	30 - 50	0.04 - 0.09	0.04 - 0.09	0.06 - 0.11	0.07 - 0.12	0.08 - 0.13	0.09 - 0.16	0.1 - 0.18	0.1 - 0.18	0.08 x DC	0.1 x DC
H	Hardened steel SKD6, SKT4, etc. 55NiCrMoV7, etc.	40 - 50 HRC	50 - 100	0.04 - 0.09	0.04 - 0.09	0.06 - 0.11	0.07 - 0.12	0.08 - 0.13	0.09 - 0.16	0.1 - 0.18	0.1 - 0.18	0.08 x DC	0.1 x DC
	Hardened steel SKD11, SKH51, etc. HS6-5-2, etc.	50 - 60 HRC	30 - 80	0.04 - 0.09	0.04 - 0.09	0.06 - 0.11	0.07 - 0.12	0.08 - 0.13	0.09 - 0.16	0.1 - 0.18	0.1 - 0.18	0.08 x DC	0.1 x DC

Profiling

VBO, VBN, VBL

ISO	Workpiece material	Hardness	Cutting speed V _c (m/min)	Feed per tooth: fz (mm/t)			Cusp height (mm)
				Tool diameter: DC (mm)			
				10	12	16	
P	Low carbon steel S45C, S55C, etc. C45, C55, etc.	- 300 HB	100 - 200	0.05 - 0.1	0.06 - 0.11	0.07 - 0.13	0.1
	High carbon steel SCM440, SCr415, etc. 42CrMo4, 15Cr3, etc.	- 300 HB	80 - 180	0.05 - 0.1	0.06 - 0.11	0.07 - 0.13	0.1
	Prehardened steel PX5, NAK80, etc.	30 - 40 HRC	80 - 160	0.05 - 0.1	0.06 - 0.11	0.07 - 0.13	0.1
M	Stainless steel SUS304, SUS316, etc. X5CrNi18-9, X5CrNiMo17-12-2, etc.	- 200 HB	60 - 100	0.05 - 0.1	0.06 - 0.11	0.07 - 0.13	0.1
K	Grey cast iron FC250, FC300, etc. 250, 300, etc.	150 - 250 HB	100 - 220	0.05 - 0.1	0.06 - 0.11	0.07 - 0.13	0.1
	Ductile cast iron FCD400, etc. 400-15S, etc.	150 - 250 HB	100 - 220	0.05 - 0.1	0.06 - 0.11	0.07 - 0.13	0.1
N	Aluminium alloys Si < 13%	-	200 - 700	0.05 - 0.1	0.06 - 0.11	0.07 - 0.13	0.1
	Aluminium alloys Si ≥ 13%	-	100 - 300	0.05 - 0.1	0.06 - 0.11	0.07 - 0.13	0.1
S	Titanium alloys Ti-6Al-4V, etc.	-	40 - 80	0.05 - 0.1	0.06 - 0.11	0.07 - 0.13	0.1
	Heat-resistant alloys Inconel718, etc.	-	20 - 40	0.05 - 0.1	0.06 - 0.11	0.07 - 0.13	0.1
H	Hardened steel SKD61, SKT4, etc. X40CrMoV5-1, 55NiCrMoV6, etc.	40 - 50 HRC	40 - 80	0.05 - 0.1	0.06 - 0.11	0.07 - 0.13	0.1
	Hardened steel SKD11, SKH, etc. X153CrMoV12, HS18-0-1, etc.	50 - 60 HRC	20 - 60	0.05 - 0.1	0.06 - 0.11	0.07 - 0.13	0.1

Chamfering and countersinking (Milling, Z-feed chamfering)

VCA

ISO	Workpiece material	Hardness	Cutting speed Vc (m/min)	Feed per tooth fz (mm/t)
P	Carbon steel S45C, S55C, etc. C45, C55, etc.	- 300 HB	60 - 100	0.03 - 0.06
	Alloy steel SCM440, SCr420, etc. 42CrMo4, 20Cr4, etc.	- 300 HB	50 - 80	0.03 - 0.06
	Prehardened steel PX5, NAK80, etc.	30 - 40 HRC	40 - 70	0.03 - 0.06
M	Stainless steel SUS304, SUS316, etc. X5CrNi18-9, X5CrNiMo17-12-2, etc.	- 200 HB	30 - 50	0.03 - 0.06
K	Grey cast iron FC250, FC300, etc. 250, 300, etc., GG250, GG300, etc.	150 - 250 HB	80 - 120	0.03 - 0.06
	Ductile cast iron FCD450, etc. 450-10S, etc., GGG450, etc.	150 - 250 HB	80 - 120	0.03 - 0.06
N	Aluminium alloys	-	100 - 200	0.04 - 0.08
S	Titanium alloys Ti-6Al-4V, etc.	-	30 - 50	0.025 - 0.05
	Heat-resistant alloys Inconel 718, etc.	-	20 - 40	0.02 - 0.04
H	Hardened steel SKD6, SKT4, etc. 55NiCrMoV7, etc.	40 - 50 HRC	30 - 50	0.025 - 0.05
	Hardened steel SKD11, SKH51, etc. HS6-5-2, etc.	50 - 60 HRC	20 - 40	0.02 - 0.04

Spot drill

VDS

ISO	Workpiece material	Hardness	Cutting speed Vc (m/min)	Feed f (mm/rev)
P	Carbon steel S45C, S55C, etc. C45, C55, etc.	- 300 HB	60 - 100	0.06 - 0.12
	Alloy steel SCM440, SCr420, etc. 42CrMo4, 20Cr4, etc.	- 300 HB	50 - 80	0.06 - 0.12
	Prehardened steel PX5, NAK80, etc.	30 - 40 HRC	40 - 70	0.06 - 0.12
M	Stainless steel SUS304, SUS316, etc. X5CrNi18-9, X5CrNiMo17-12-2, etc.	- 200 HB	30 - 50	0.06 - 0.12
K	Grey cast iron FC250, FC300, etc. 250, 300, etc., GG250, GG300, etc.	150 - 250 HB	80 - 120	0.06 - 0.12
	Ductile cast iron FCD450, etc. 450-10S, etc., GGG450, etc.	150 - 250 HB	80 - 120	0.06 - 0.12
N	Aluminium alloys	-	100 - 200	0.08 - 0.16
S	Titanium alloys Ti-6Al-4V, etc.	-	30 - 50	0.05 - 0.1
	Heat-resistant alloys Inconel 718, etc.	-	20 - 40	0.04 - 0.08
H	Hardened steel SKD6, SKT4, etc. 55NiCrMoV7, etc.	40 - 50 HRC	30 - 50	0.05 - 0.1
	Hardened steel SKD11, SKH51, etc. HS6-5-2, etc.	50 - 60 HRC	20 - 40	0.04 - 0.08

Center drill

VDP

ISO	Workpiece material	Hardness	Cutting speed Vc (m/min)	Feed : f (mm/rev)						
				VDP107	VDP165	VDP207	VDP324 / VDP328	VDP409 / VDP412	VDP509 / VDP513	VDP641
P	Carbon steel S45C, S55C, etc. C45, C55, etc.	- 300 HB	40 - 80	0.02 - 0.04	0.025 - 0.05	0.025 - 0.05	0.04 - 0.08	0.05 - 0.1	0.05 - 0.1	0.06 - 0.12
	Alloy steel SCM440, SCR420, etc. 42CrMo4, 20Cr4, etc.	- 300 HB	30 - 50	0.02 - 0.04	0.025 - 0.05	0.025 - 0.05	0.04 - 0.08	0.05 - 0.1	0.05 - 0.1	0.06 - 0.12
	Prehardened steel PX5, NAK80, etc.	30 - 40 HRC	20 - 30	0.02 - 0.04	0.025 - 0.05	0.025 - 0.05	0.04 - 0.08	0.05 - 0.1	0.05 - 0.1	0.06 - 0.12
M	Stainless steel SUS304, SUS316, etc. X5CrNi18-9, X5CrNiMo17-12-2, etc.	- 200 HB	15 - 25	0.015 - 0.03	0.02 - 0.04	0.02 - 0.04	0.04 - 0.08	0.05 - 0.1	0.05 - 0.1	0.06 - 0.12
K	Grey cast iron FC250, FC300, etc. 250, 300, etc., GG250, GG300, etc.	150 - 250 HB	60 - 100	0.02 - 0.04	0.025 - 0.05	0.025 - 0.05	0.05 - 0.09	0.07 - 0.012	0.07 - 0.12	0.12 - 0.18
	Ductile cast iron FCD450, etc. 450-10S, etc., GGG450, etc.	150 - 250 HB	60 - 100	0.02 - 0.04	0.025 - 0.05	0.025 - 0.05	0.04 - 0.08	0.05 - 0.1	0.05 - 0.1	0.1 - 0.15
S	Titanium alloys Ti-6Al-4V, etc.	-	15 - 25	0.01 - 0.02	0.01 - 0.02	0.015 - 0.03	0.04 - 0.07	0.04 - 0.07	0.04 - 0.07	0.04 - 0.07
	Heat-resistant alloys Inconel 718, etc.	-	10 - 20	0.01 - 0.02	0.01 - 0.02	0.015 - 0.03	0.03 - 0.06	0.03 - 0.06	0.03 - 0.06	0.03 - 0.06
H	Hardened steel SKD6, SKT4, etc. 55NiCrMoV7, etc.	40 - 50 HRC	15 - 25	-	-	-	0.04 - 0.07	0.04 - 0.07	0.04 - 0.07	0.04 - 0.07
	Hardened steel SKD11, SKH51, etc. HS6-5-2, etc.	50 - 60 HRC	10 - 20	-	-	-	0.03 - 0.06	0.03 - 0.06	0.03 - 0.06	0.03 - 0.06

Hole making

- 140 AddMeisterDrill
- 146 DrillMeister
- 166 Solid4FlutesDrill
- 170 ReamMeister

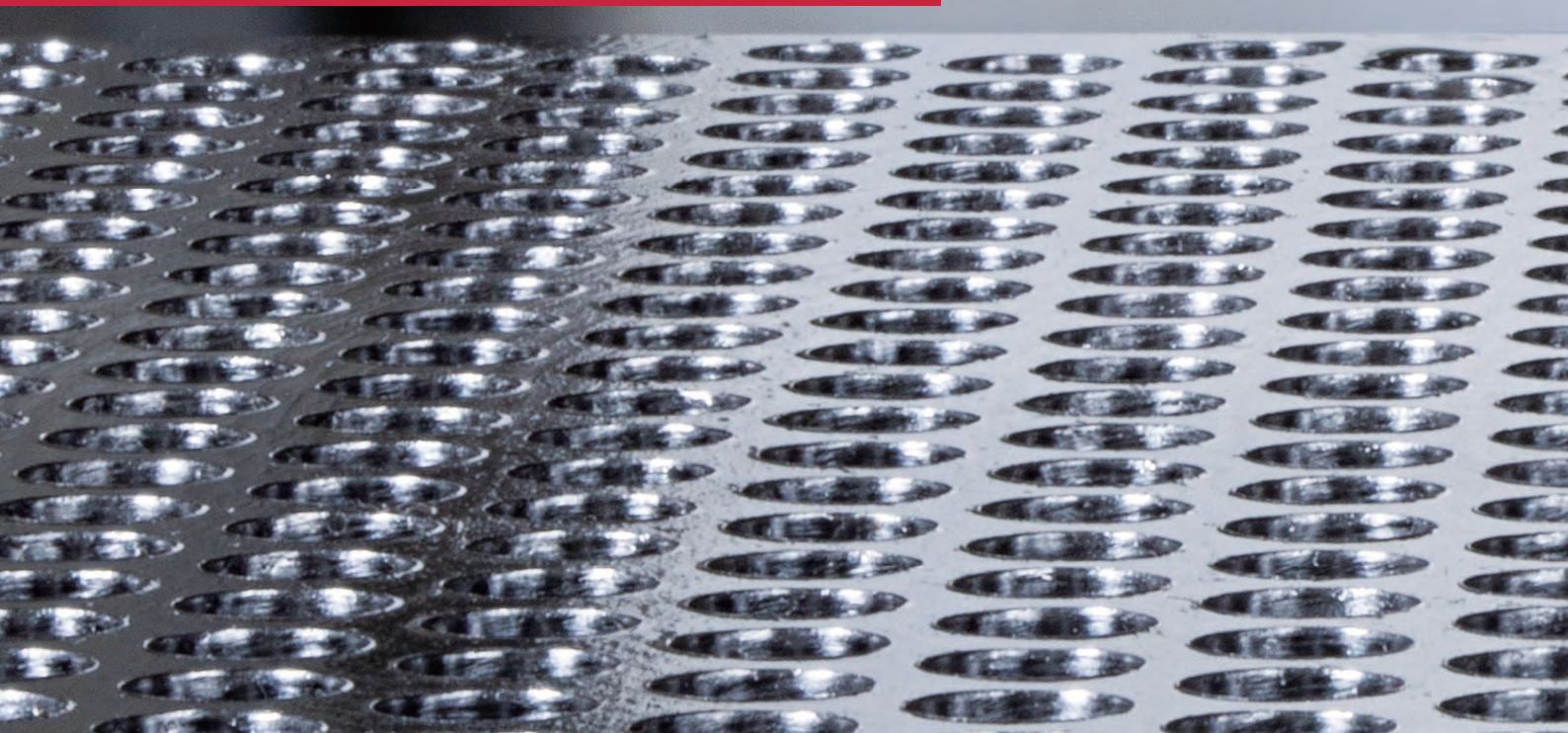

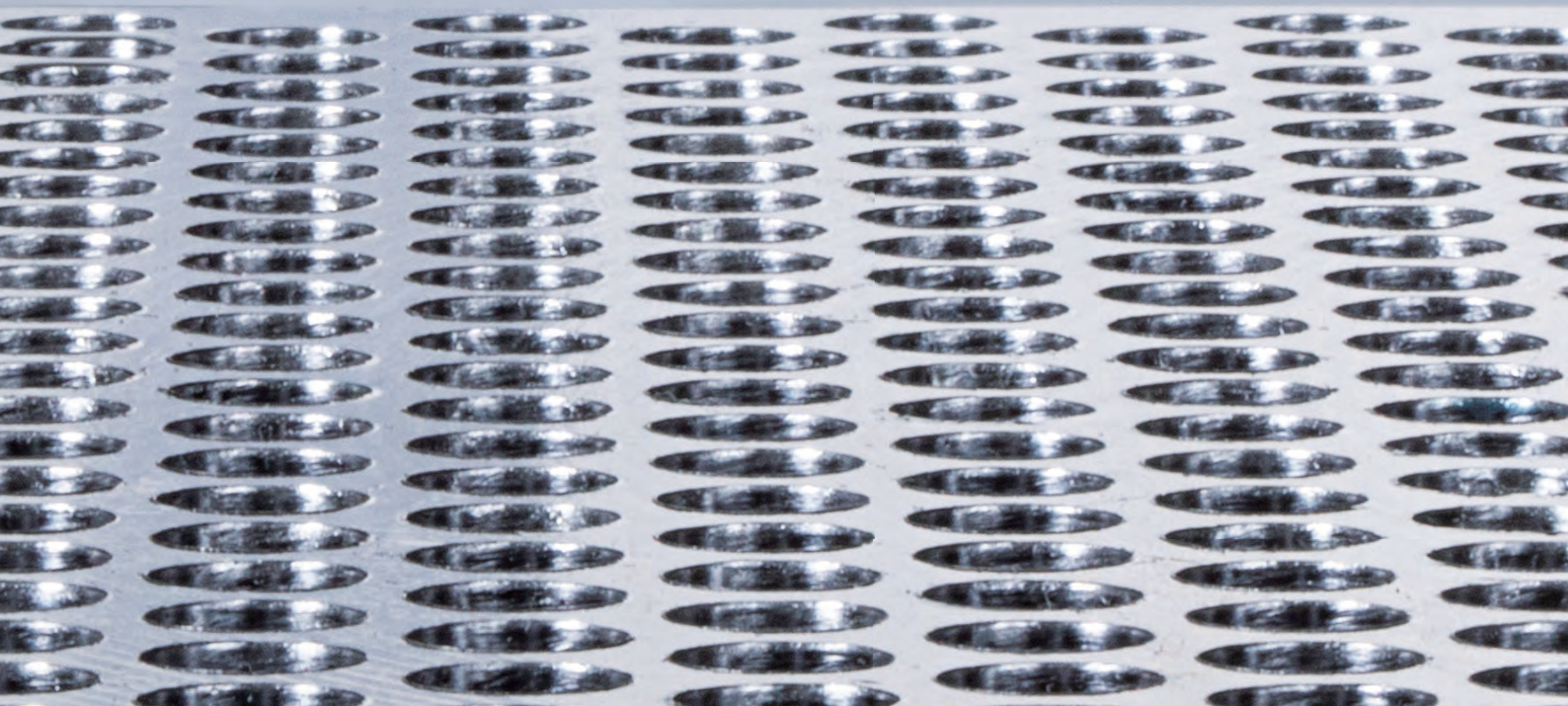

ADD M^{EISTER} DRILL

Drilling

WORLD'S SMALLEST EXCHANGEABLE DRILL HEADS SERIES

ADD superb performance in small drilling operations

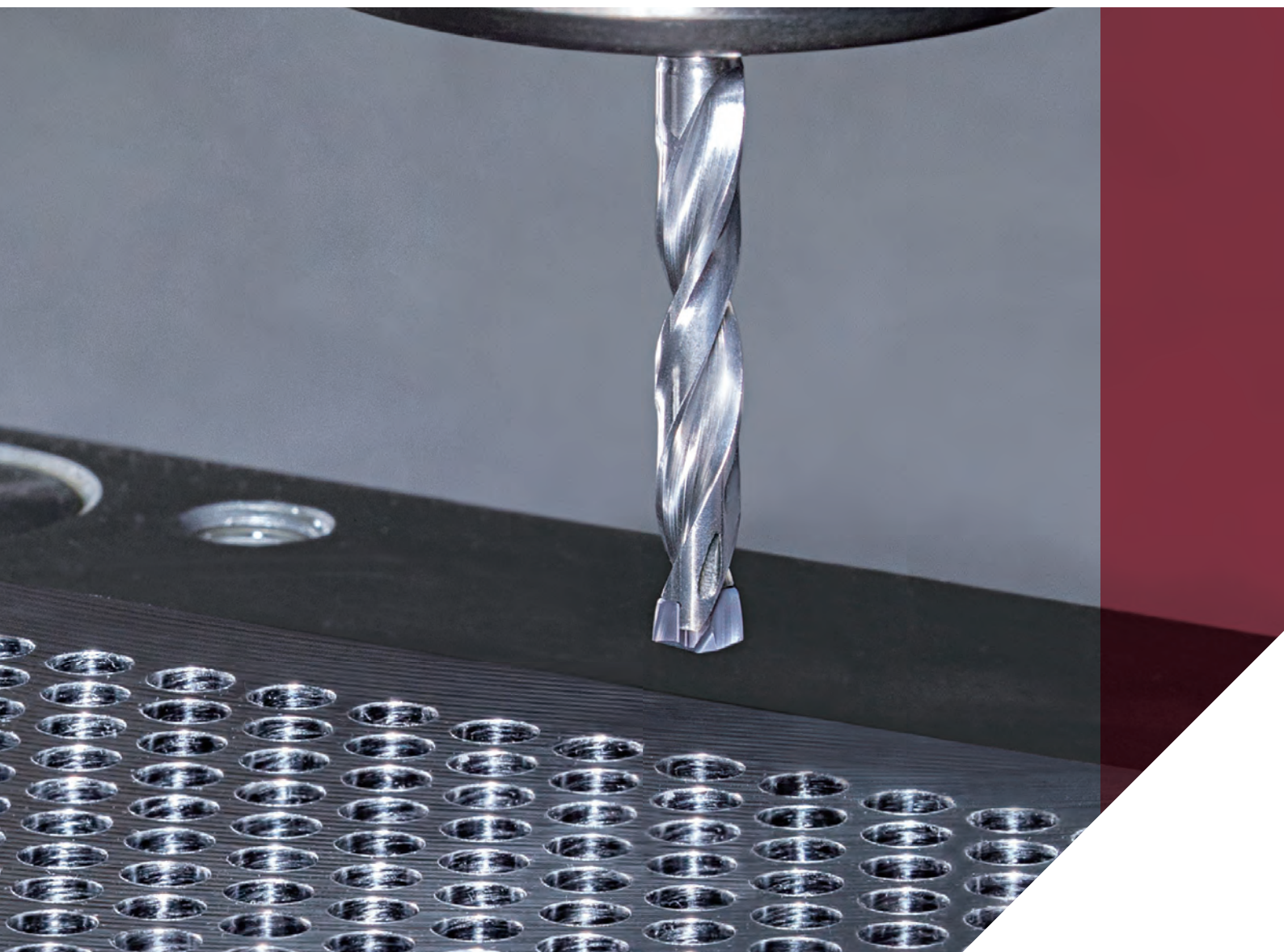



- Through-coolant capability allows superior chip evacuation and long and predictable tool life.
- Provides even better hole tolerances than solid drills.

- Two types of drill heads are available.

Lineup

Heads

- DMP

General purpose drilling head ideal for various drilling applications

DC = $\varnothing 4$ - $\varnothing 5.9$ mm

- DMC

High precision drilling head with quick centering cutting edge style

DC = $\varnothing 4$ - $\varnothing 5.9$ mm

Drill bodies

- **TID-R**: Cylindrical shank type

Available in 3xD and 5xD

Grades

- **AH725**: Versatile grade with a good balance of wear and fracture resistance
- **AH9130**: Wear-resistant grade that enables long tool life

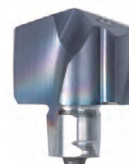

DMP



DMC



The tiny drill head is supplied in a dedicated user-friendly key, enabling easy and secure mounting with no setup time.

Scan this QR code to find out more about this tool!



DRILL SHANK

TID-R L/D=3

Head changeable drill

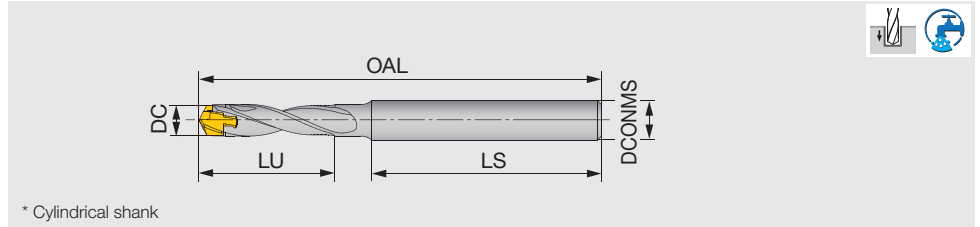

Designation	DC	DCONMS	LU	LS	OAL		Pocket size	Head
					DMP	DMC		
TID040R06-3**	4 - 4.4	6	12.62	35	57.7	58.11	4	DM*040 - DM*044
TID045R06-3	4.5 - 4.9	6	14.16	35	59.65	59.91	4.5	DM*045 - DM*049
TID050R06-3	5 - 5.4	6	15.73	35	61.35	61.79	5	DM*050 - DM*054
TID055R06-3	5.5 - 5.9	6	17.31	35	64	64.32	5.5	DM*055 - DM*059

**Will be released in December 2021

Tool diameter	Hole diameter tolerance*
ø4 - ø5.9	+0.04 / 0

*Just for reference

- An overall length (OAL) differs based on each head geometry.
- When using the drill at a higher feed rate, make sure to provide an axial support by placing the overhang adjusting screw at the drill shank end in the tool holder. This will prevent high thrust force from pushing the drill back into the holder during drilling.
- When axially adjusting the shank inside the holder to obtain a required drill overhang, make sure the shank length remaining inside the holder does not come short of the minimum clamping length (LSCN) specified by the holder supplier.

TID-R L/D=5

Head changeable drill

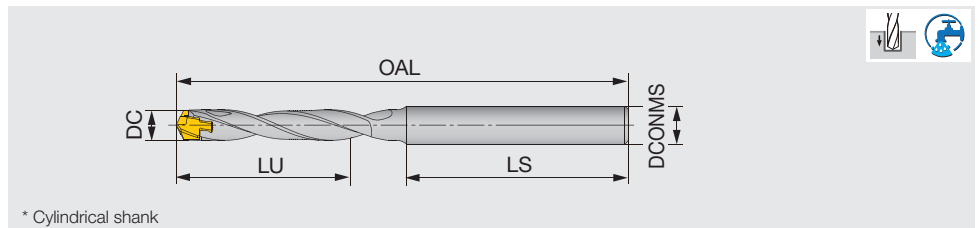

Designation	DC	DCONMS	LU	LS	OAL		Pocket size	Head
					DMP	DMC		
TID040R06-5**	4 - 4.4	6	20.62	35	65.7	66.11	4	DM*040 - DM*044
TID045R06-5	4.5 - 4.9	6	23.16	35	68.65	68.91	4.5	DM*045 - DM*049
TID050R06-5	5 - 5.4	6	25.73	35	71.3	71.64	5	DM*050 - DM*054
TID055R06-5	5.5 - 5.9	6	28.31	35	74.15	74.47	5.5	DM*055 - DM*059

**Will be released in December 2021

Tool diameter	Hole diameter tolerance*
ø4 - ø5.9	+0.05 / 0

*Just for reference

- An overall length (OAL) differs based on each head geometry.
- When using the drill at a higher feed rate, make sure to provide an axial support by placing the overhang adjusting screw at the drill shank end in the tool holder. This will prevent high thrust force from pushing the drill back into the holder during drilling.
- When axially adjusting the shank inside the holder to obtain a required drill overhang, make sure the shank length remaining inside the holder does not come short of the minimum clamping length (LSCN) specified by the holder supplier.

DRILL HEAD

DMP General purpose

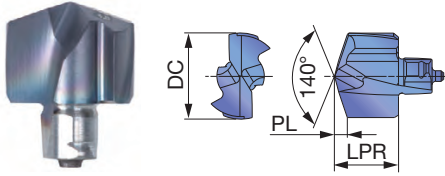

DMC High precision drilling

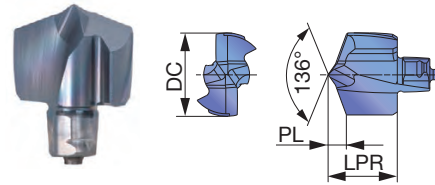

P	Steel	★		
M	Stainless			
K	Cast iron	★		
N	Non-ferrous			
S	Superalloys			
H	Hard materials			

★ : First choice

Designation	DC	LPR	Coated		PL	Body
			AH725			
DMP040*	4	3.1	●		0.62	TID*040...
DMP041*	4.1	3.1	●		0.64	TID*040...
DMP042*	4.2	3.1	●		0.66	TID*040...
DMP043*	4.3	3.1	●		0.67	TID*040...
DMP044*	4.4	3.1	●		0.69	TID*040...
DMP045	4.5	3.55	●		0.66	TID*045...
DMP046	4.6	3.55	●		0.68	TID*045...
DMP047	4.7	3.55	●		0.70	TID*045...
DMP048	4.8	3.55	●		0.71	TID*045...
DMP049	4.9	3.55	●		0.73	TID*045...
DMP050	5	3.7	●		0.73	TID*050...
DMP051	5.1	3.7	●		0.75	TID*050...
DMP052	5.2	3.7	●		0.77	TID*050...
DMP053	5.3	3.7	●		0.78	TID*050...
DMP054	5.4	3.7	●		0.8	TID*050...
DMP055	5.5	3.85	●		0.81	TID*055...
DMP056	5.6	3.85	●		0.83	TID*055...
DMP057	5.7	3.85	●		0.85	TID*055...
DMP058	5.8	3.85	●		0.86	TID*055...
DMP059	5.9	3.85	●		0.88	TID*055...

ø4 - ø5.9 = 2 pieces per package

● : New

*Will be released in December 2021

P	Steel	★		
M	Stainless			
K	Cast iron	★		
N	Non-ferrous			
S	Superalloys			
H	Hard materials			

★ : First choice

Designation	DC	LPR	Coated		PL	Body
			AH9130			
DMC040*	4	3.51	●		0.86	TID*040...
DMC041*	4.1	3.51	●		0.88	TID*040...
DMC042*	4.2	3.51	●		0.9	TID*040...
DMC043*	4.3	3.51	●		0.92	TID*040...
DMC044*	4.4	3.51	●		0.94	TID*040...
DMC045*	4.5	3.81	●		0.97	TID*045...
DMC046*	4.6	3.81	●		0.99	TID*045...
DMC047*	4.7	3.81	●		1.01	TID*045...
DMC048*	4.8	3.81	●		1.03	TID*045...
DMC049*	4.9	3.81	●		1.05	TID*045...
DMC050	5	4.14	●		1.09	TID*050...
DMC051	5.1	4.14	●		1.11	TID*050...
DMC052	5.2	4.14	●		1.13	TID*050...
DMC053	5.3	4.14	●		1.15	TID*050...
DMC054	5.4	4.14	●		1.17	TID*050...
DMC055	5.5	4.17	●		1.22	TID*055...
DMC056	5.6	4.17	●		1.24	TID*055...
DMC057	5.7	4.17	●		1.26	TID*055...
DMC058	5.8	4.17	●		1.28	TID*055...
DMC059	5.9	4.17	●		1.3	TID*055...

ø4 - ø5.9 = 2 pieces per package

● : New

*Will be released in December 2021

Tool diameter	Head diameter tolerance
ø4 - ø5.9	+0.018 / 0

Tool diameter	Head diameter tolerance
ø4 - ø5.9	+0.018 / 0



STANDARD CUTTING CONDITIONS

ISO	Workpiece material	Cutting speed Vc (m/min)	Feed: f (mm/rev)		
			DC (mm)		
			ø4 - 4.4	ø4.5 - 4.9	ø5 - 5.9
P	Low carbon steels (C < 0.3) SS400, SM490, S25C, etc. C15E4, E275A, E355D, etc.	80 - 140	0.04 - 0.07	0.04 - 0.08	0.07 - 0.13
	High carbon steels (C > 0.3) S45C, S55C, etc. C45, C55, etc.	70 - 120	0.04 - 0.07	0.04 - 0.08	0.07 - 0.13
	Low alloy steels SCM415, etc. 18CrMo4, etc.	70 - 120	0.04 - 0.06	0.05 - 0.08	0.07 - 0.13
	Alloy steels SCM440, SCr420, etc. 42CrMo4, 20Cr4, etc.	40 - 90	0.04 - 0.07	0.05 - 0.08	0.07 - 0.13
M	Stainless steels SUS304, SUS316, etc. X5CrNi18-9, X5CrNiMo17-12-2, etc.	30 - 70	-	-	0.04 - 0.08
K	Grey cast irons FC250, etc. GG25, etc.	80 - 180	0.04 - 0.08	0.04 - 0.08	0.1 - 0.15
	Ductile cast irons FCD700, etc. GGG70, etc.	80 - 140	0.04 - 0.08	0.04 - 0.08	0.1 - 0.15
N	Aluminium alloys ADC12, etc. AlSi11Cu3, etc.	80 - 220	-	-	-
S	Titanium alloys Ti-6Al-4V, etc.	20 - 50	-	-	-
	Nickel-based alloys	20 - 50	-	-	-
H	Hardened steel	20 - 50	-	-	-

- Cutting conditions in the above table show standard cutting conditions
 - Cutting conditions may change due to the rigidity and power of the machine and the workpiece material

- Machined hole diameter may change depending upon the rigidity of the machine tool or cutting conditions

TECHNICAL GUIDELINES

Drilling head mounting procedure

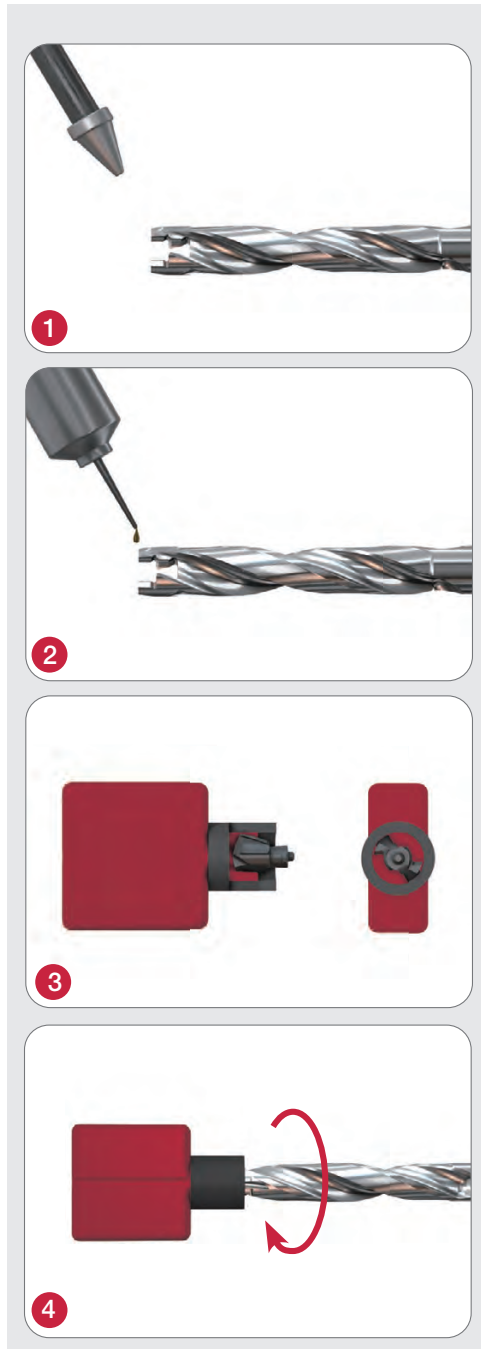

Drilling limitations

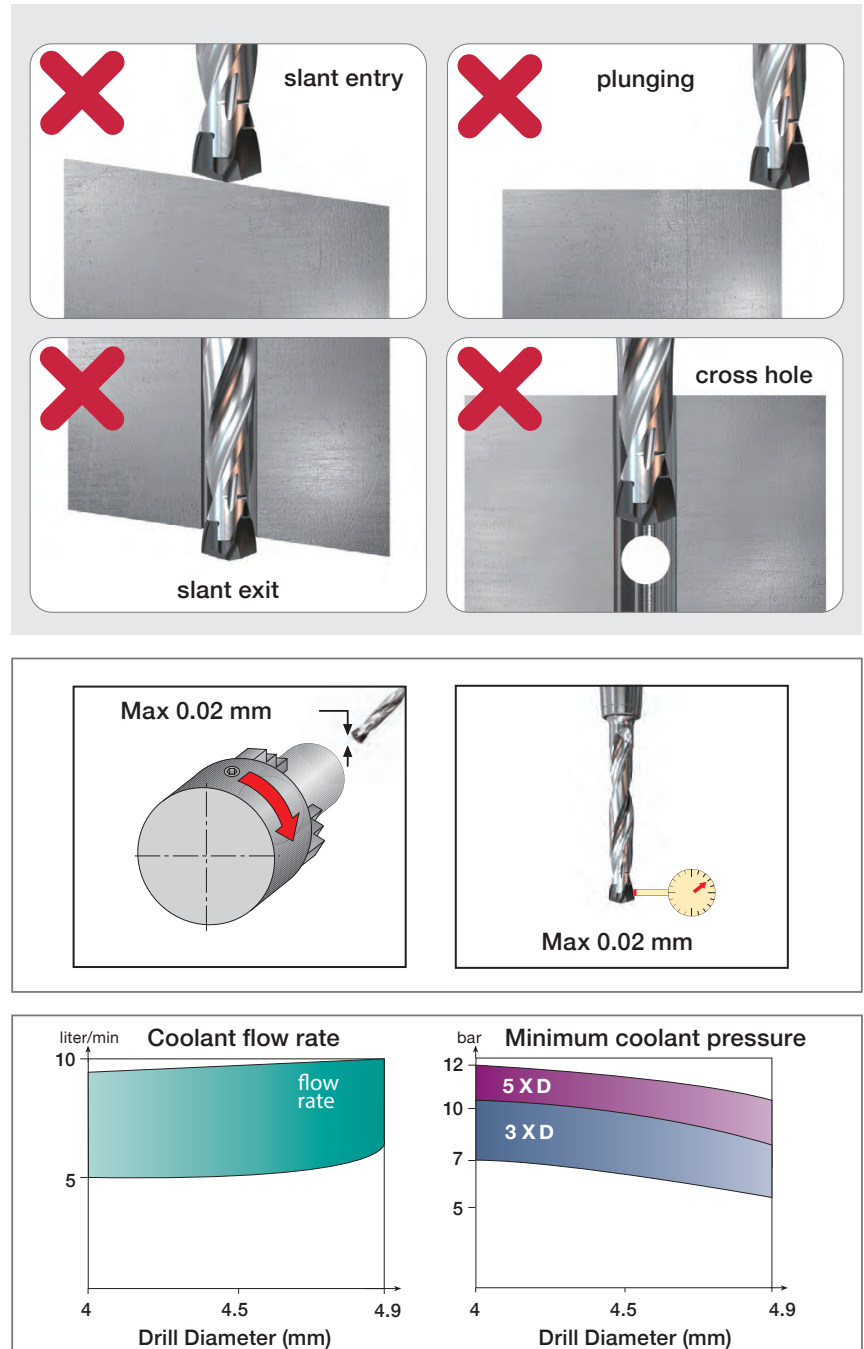

Coolant recommendations

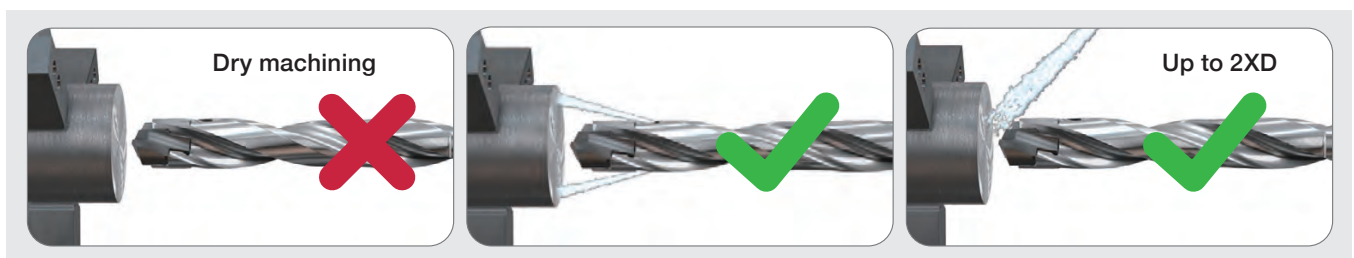

DRILLMEISTER

Drilling

EXCHANGEABLE HEAD DRILL SYSTEM FOR SUPERIOR DRILLING PERFORMANCE AND LONG TOOL LIFE

ADD higher productivity in your drilling operations

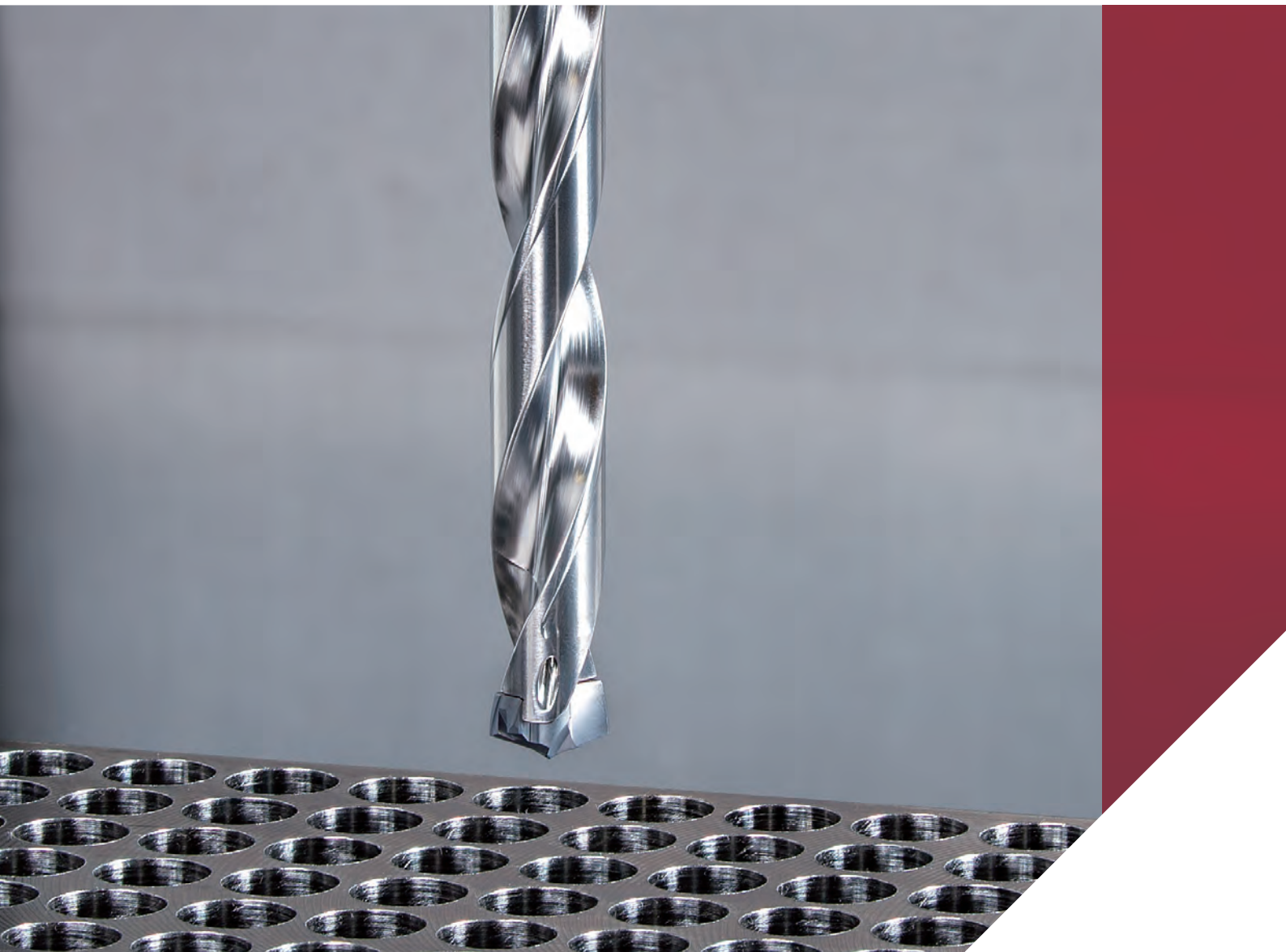



- Quick drill head change for reduced machine downtime.
- Tool inventory and management costs are significantly reduced as there is no need for regrinding.

- Drill bodies are offered in a wide range of sizes and styles, allowing optimal tool assembly for secure and productive drilling.

Lineup

Heads

- DMP

General purpose drilling head ideal for various drilling applications

DC = $\phi 6$ - $\phi 25.9$ mm

- DMC

High precision drilling head with double-margined drill periphery and quick centering cutting edge style

DC = $\phi 6$ - $\phi 25.9$ mm

- DMF

180° flat edges for counterboring and flat bottoms

DC = $\phi 6$ - $\phi 25.9$ mm

- DMH

General purpose head with enhanced cutting edge

DC = $\phi 10$ - $\phi 19.5$ mm

- DMN

Drill head with sharp edges for non-ferrous materials

DC = $\phi 10$ - $\phi 19.5$ mm

Grades

- **AH725:** Versatile grade with a good balance of wear and fracture resistance, ideal for all material groups
- **AH9130:** Wear-resistant grade that enables long tool life
- **KS15F:** Designed for non-ferrous applications

Drill bodies

- **TID-F:** Flange type, Available in 1.5xD, 3xD, 5xD, and 8xD

- **TID-R:** Cylindrical shank type, Available in 3.5xD, 6xD, 8xD, and 12xD

- **TIDC:** Available in 3xD and 5xD suitable for use with TIDCF chamfering holders.

- **TIDCF chamfering holder:** Available with 3 types of inserts in chamfering angles of 30°, 45°, and 60°



DMP



DMC



DMF



DMH



DMN

Scan this QR code to find out more about this tool!



DRILL BODIES

TID-F L/D=1.5

Head changeable drill

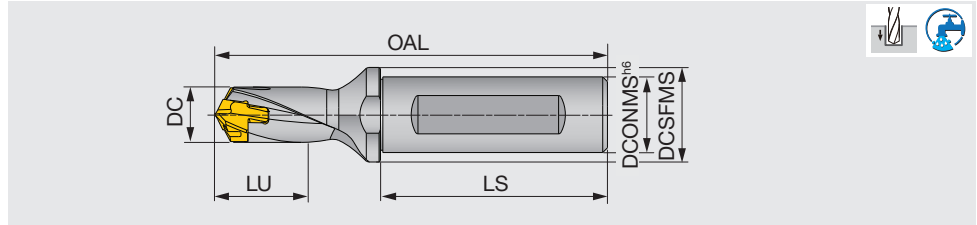

Designation	DC	DCONMS	DCSFMS	LU	LS	OAL			Pocket size	Head
						DMP/H/N	DMC	DMF		
TID060F12-1.5	6 - 6.4	12	16	10	45	67.85	68	67.01	6	DM*060 - DM*064
TID065F12-1.5	6.5 - 6.9	12	16	11	45	68.9	69.05	68.03	6.5	DM*065 - DM*069
TID070F12-1.5	7 - 7.4	12	16	12	45	69.95	70.4	69.08	7	DM*070 - DM*074
TID075F12-1.5	7.5 - 7.9	12	16	13	45	70.7	71.15	69.83	7	DM*075 - DM*079
TID080F12-1.5	8 - 8.9	12	16	14	45	72.25	72.4	71.39	8	DM*080 - DM*089
TID090F12-1.5	9 - 9.9	12	16	16	45	74.15	74.3	73.11	9	DM*090 - DM*099
TID100F16-1.5	10 - 10.9	16	20	17	48	79.05	79.67	77.72	10	DM*100 - DM*109
TID110F16-1.5	11 - 11.9	16	20	19	48	80.95	81.6	79.4	11	DM*110 - DM*119
TID120F16-1.5	12 - 12.9	16	20	20	48	82.8	83.43	81.21	12	DM*120 - DM*129
TID130F16-1.5	13 - 13.9	16	20	22	48	84.9	85.65	83.03	13	DM*130 - DM*139
TID140F16-1.5	14 - 14.9	16	20	24	48	88.95	89.76	86.96	14	DM*140 - DM*149
TID150F20-1.5	15 - 15.9	20	25	26	50	96.03	96.94	93.93	15	DM*150 - DM*159
TID160F20-1.5	16 - 16.9	20	25	27	50	99.1	100.07	96.84	16	DM*160 - DM*169
TID170F20-1.5	17 - 17.9	20	25	29	50	102.2	103.18	99.65	17	DM*170 - DM*179
TID180F25-1.5	18 - 18.9	25	32	30	56	111.3	112.35	108.45	18	DM*180 - DM*189
TID190F25-1.5	19 - 19.9	25	32	33	56	114.3	115.41	111.29	19	DM*190 - DM*199
TID200F25-1.5	20 - 20.9	25	32	34	56	117.4	118.62	115.12	20	DM*200 - DM*209
TID210F25-1.5	21 - 21.9	25	32	36	56	120.48	121.7	118.04	21	DM*210 - DM*219
TID220F25-1.5	22 - 22.9	25	32	37	56	123.56	124.84	120.86	22	DM*220 - DM*229
TID230F32-1.5	23 - 23.9	32	42	39	60	130.63	132.01	127.78	23	DM*230 - DM*239
TID240F32-1.5	24 - 24.9	32	42	40	60	133.7	135.11	130.71	24	DM*240 - DM*249
TID250F32-1.5	25 - 25.9	32	42	43	60	136.8	138.28	133.65	25	DM*250 - DM*259

Tool diameter	Hole diameter tolerance*
ø6 - ø17.9	+0.03 / 0
ø18 - ø25.9	+0.035 / 0

- An overall length (OAL) differs based on each head geometry.
 - For drill diameters from ø8 mm - ø9.9 mm, the drill shoulder to shank bottom distance when a DMC drill head is mounted is 0.3 mm shorter when compared with a DMP head of the equivalent sizes. The distances are the same for the DMC and DMP drill heads in other diameters than the above.

*Just for reference

TID-F L/D=3

Head changeable drill

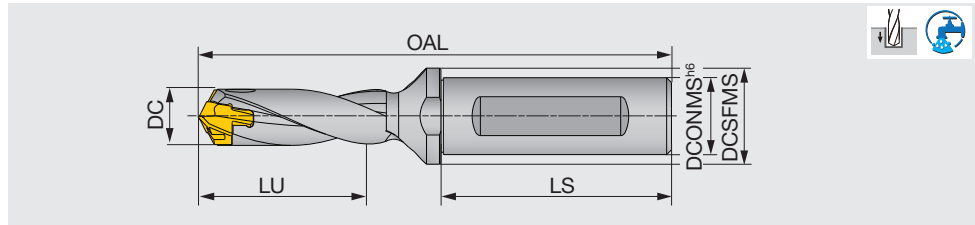

Designation	DC	DCONMS	DCSFMS	LU	LS	OAL			Pocket size	Head
						DMP/H/N	DMC	DMF		
TID060F12-3	6 - 6.4	12	16	19	45	76.85	77	76.01	6	DM*060 - DM*064
TID065F12-3	6.5 - 6.9	12	16	21	45	78.65	78.8	77.78	6.5	DM*065 - DM*069
TID070F12-3	7 - 7.4	12	16	22	45	80.45	80.9	79.58	7	DM*070 - DM*074
TID075F12-3	7.5 - 7.9	12	16	24	45	81.95	82.4	81.08	7	DM*075 - DM*079
TID080F12-3	8 - 8.4	12	16	26	45	84.25	84.4	83.39	8	DM*080 - DM*084
TID085F12-3	8.5 - 8.9	12	16	28	45	85.75	85.9	84.89	8	DM*085 - DM*089
TID090F12-3	9 - 9.4	12	16	29	45	87.65	87.8	86.61	9	DM*090 - DM*094
TID095F12-3	9.5 - 9.9	12	16	31	45	89.15	89.3	88.11	9	DM*095 - DM*099
TID100F16-3	10 - 10.4	16	20	32	48	94.05	94.67	92.72	10	DM*100 - DM*104
TID105F16-3	10.5 - 10.9	16	20	34	48	95.55	96.17	94.22	10	DM*105 - DM*109
TID110F16-3	11 - 11.4	16	20	35	48	97.45	98.1	95.9	11	DM*110 - DM*114
TID115F16-3	11.5 - 11.9	16	20	37	48	98.95	99.6	97.4	11	DM*115 - DM*119
TID120F16-3	12 - 12.4	16	20	38	48	100.8	101.43	99.21	12	DM*120 - DM*124
TID125F16-3	12.5 - 12.9	16	20	39	48	102.3	102.93	100.71	12	DM*125 - DM*129
TID130F16-3	13 - 13.4	16	20	41	48	104.4	105.15	102.53	13	DM*130 - DM*134
TID135F16-3	13.5 - 13.9	16	20	44	48	105.9	106.65	104.03	13	DM*135 - DM*139
TID140F16-3	14 - 14.4	16	20	45	48	109.95	110.76	107.96	14	DM*140 - DM*144
TID145F16-3	14.5 - 14.9	16	20	47	48	111.45	112.26	109.46	14	DM*145 - DM*149
TID150F20-3	15 - 15.9	20	25	48	50	118.53	119.44	116.43	15	DM*150 - DM*159
TID160F20-3	16 - 16.9	20	25	51	50	123.1	124.07	120.84	16	DM*160 - DM*169
TID170F20-3	17 - 17.9	20	25	54	50	127.7	128.68	125.15	17	DM*170 - DM*179
TID180F25-3	18 - 18.9	25	32	57	56	138.3	139.35	135.45	18	DM*180 - DM*189
TID190F25-3	19 - 19.9	25	32	61	56	142.8	143.91	139.79	19	DM*190 - DM*199
TID200F25-3	20 - 20.9	25	32	64	56	147.4	148.62	145.12	20	DM*200 - DM*209
TID210F25-3	21 - 21.9	25	32	67	56	151.98	153.2	149.54	21	DM*210 - DM*219
TID220F25-3	22 - 22.9	25	32	70	56	156.56	157.84	153.86	22	DM*220 - DM*229
TID230F32-3	23 - 23.9	32	42	73	60	165.13	166.51	162.28	23	DM*230 - DM*239
TID240F32-3	24 - 24.9	32	42	76	60	169.7	171.11	166.71	24	DM*240 - DM*249
TID250F32-3	25 - 25.9	32	42	80	60	174.3	175.78	171.15	25	DM*250 - DM*259

Tool diameter	Hole diameter tolerance*
ø6 - ø17.9	+0.04 / 0
ø18 - ø25.9	+0.045 / 0

- An overall length (OAL) differs based on each head geometry.
 - For drill diameters from ø8 mm - ø9.9 mm, the drill shoulder to shank bottom distance when a DMC drill head is mounted is 0.3 mm shorter when compared with a DMP head of the equivalent sizes. The distances are the same for the DMC and DMP drill heads in other diameters than the above.

*Just for reference

TID-F L/D=5

Head changeable drill

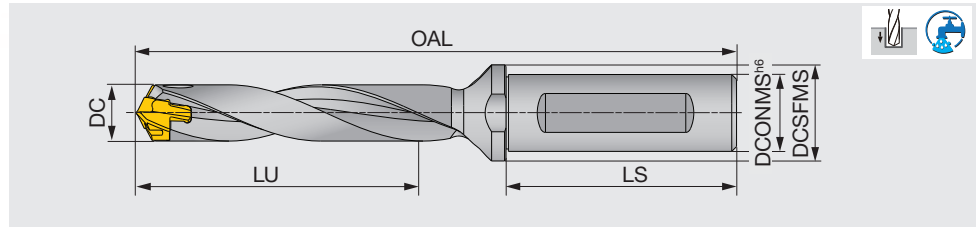

Designation	DC	DCONMS	DCSFMS	LU	LS	OAL			Pocket size	Head
						DMP/H/N	DMC	DMF		
TID060F12-5	6 - 6.4	12	16	31	45	88.85	89	88.01	6	DM*060 - DM*064
TID065F12-5	6.5 - 6.9	12	16	34	45	91.65	91.8	90.78	6.5	DM*065 - DM*069
TID070F12-5	7 - 7.4	12	16	36	45	94.45	94.9	93.58	7	DM*070 - DM*074
TID075F12-5	7.5 - 7.9	12	16	39	45	96.95	97.4	96.08	7	DM*075 - DM*079
TID080F12-5	8 - 8.4	12	16	42	45	100.25	100.4	99.39	8	DM*080 - DM*084
TID085F12-5	8.5 - 8.9	12	16	45	45	102.75	102.9	101.89	8	DM*085 - DM*089
TID090F12-5	9 - 9.4	12	16	47	45	105.65	105.8	104.61	9	DM*090 - DM*094
TID095F12-5	9.5 - 9.9	12	16	50	45	108.15	108.3	107.11	9	DM*095 - DM*099
TID100F16-5	10 - 10.4	16	20	52	48	114.05	114.67	112.72	10	DM*100 - DM*104
TID105F16-5	10.5 - 10.9	16	20	55	48	116.55	117.17	115.22	10	DM*105 - DM*109
TID110F16-5	11 - 11.4	16	20	57	48	119.45	120.1	117.9	11	DM*110 - DM*114
TID115F16-5	11.5 - 11.9	16	20	60	48	121.95	122.6	120.4	11	DM*115 - DM*119
TID120F16-5	12 - 12.4	16	20	62	48	124.8	125.43	123.21	12	DM*120 - DM*124
TID125F16-5	12.5 - 12.9	16	20	64	48	127.3	127.93	125.71	12	DM*125 - DM*129
TID130F16-5	13 - 13.4	16	20	67	48	130.4	131.15	128.53	13	DM*130 - DM*134
TID135F16-5	13.5 - 13.9	16	20	71	48	132.9	133.65	131.03	13	DM*135 - DM*139
TID140F16-5	14 - 14.4	16	20	73	48	137.95	138.76	135.96	14	DM*140 - DM*144
TID145F16-5	14.5 - 14.9	16	20	76	48	140.45	141.26	138.46	14	DM*145 - DM*149
TID150F20-5	15 - 15.9	20	25	78	50	148.53	149.44	146.43	15	DM*150 - DM*159
TID160F20-5	16 - 16.9	20	25	83	50	155.1	156.07	152.84	16	DM*160 - DM*169
TID170F20-5	17 - 17.9	20	25	88	50	161.7	162.68	159.15	17	DM*170 - DM*179
TID180F25-5	18 - 18.9	25	32	93	56	174.3	175.35	171.45	18	DM*180 - DM*189
TID190F25-5	19 - 19.9	25	32	99	56	180.8	181.91	177.79	19	DM*190 - DM*199
TID200F25-5	20 - 20.9	25	32	104	56	187.6	188.82	185.32	20	DM*200 - DM*209
TID210F25-5	21 - 21.9	25	32	109	56	194.2	195.42	191.76	21	DM*210 - DM*219
TID220F25-5	22 - 22.9	25	32	114	56	200.8	202.08	198.1	22	DM*220 - DM*229
TID230F32-5	23 - 23.9	32	42	119	60	211.3	212.68	208.45	23	DM*230 - DM*239
TID240F32-5	24 - 24.9	32	42	124	60	217.9	219.31	214.91	24	DM*240 - DM*249
TID250F32-5	25 - 25.9	32	42	130	60	224.5	225.98	221.35	25	DM*250 - DM*259

Tool diameter	Hole diameter tolerance*
ø6 - ø25.9	+0.05 / 0

- An overall length (OAL) differs based on each head geometry.
 - For drill diameters from ø8 mm - ø9.9 mm, the drill shoulder to shank bottom distance when a DMC drill head is mounted is 0.3 mm shorter when compared with a DMP head of the equivalent sizes. The distances are the same for the DMC and DMP drill heads in other diameters than the above.

*Just for reference

TID-F L/D=8

Head changeable drill

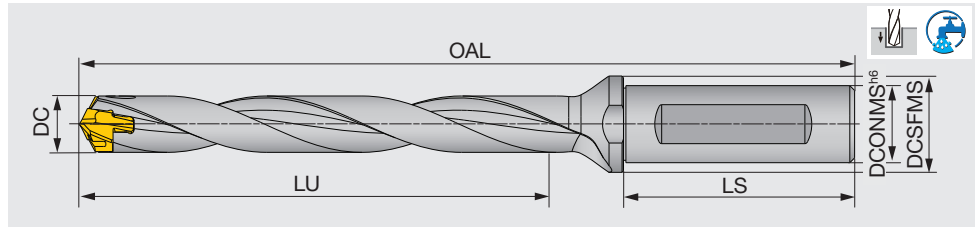

Designation	DC	DCONMS	DCSFMS	LU	LS	OAL			Pocket size	Head
						DMP/H/N	DMC	DMF		
TID070F12-8	7 - 7.4	12	16	57	45	115.45	115.90	114.58	7	DM*070 - DM*074
TID075F12-8	7.5 - 7.9	12	16	61	45	119.45	119.90	118.58	7	DM*075 - DM*079
TID080F12-8	8 - 8.4	12	16	66	45	124.25	124.40	123.39	8	DM*080 - DM*084
TID085F12-8	8.5 - 8.9	12	16	70	45	128.25	128.40	127.39	8	DM*085 - DM*089
TID090F12-8	9 - 9.4	12	16	74	45	132.65	132.80	131.61	9	DM*090 - DM*094
TID095F12-8	9.5 - 9.9	12	16	78	45	136.65	136.80	135.61	9	DM*095 - DM*099
TID100F16-8	10 - 10.4	16	20	82	48	144.05	144.67	142.72	10	DM*100 - DM*104
TID105F16-8	10.5 - 10.9	16	20	86	48	148.05	148.67	146.72	10	DM*105 - DM*109
TID110F16-8	11 - 11.4	16	20	90	48	152.45	153.10	150.90	11	DM*110 - DM*114
TID115F16-8	11.5 - 11.9	16	20	94	48	156.45	157.10	154.90	11	DM*115 - DM*119
TID120F16-8	12 - 12.4	16	20	98	48	160.80	161.43	159.21	12	DM*120 - DM*124
TID125F16-8	12.5 - 12.9	16	20	102	48	164.80	165.43	163.21	12	DM*125 - DM*129
TID130F16-8	13 - 13.4	16	20	106	48	169.40	170.15	167.53	13	DM*130 - DM*134
TID135F16-8	13.5 - 13.9	16	20	111	48	173.40	174.15	171.53	13	DM*135 - DM*139
TID140F16-8	14 - 14.4	16	20	115	48	179.95	180.76	177.96	14	DM*140 - DM*144
TID145F16-8	14.5 - 14.9	16	20	119	48	183.95	184.76	181.96	14	DM*145 - DM*149
TID150F20-8	15 - 15.9	20	25	123	50	193.53	194.44	191.43	15	DM*150 - DM*159
TID160F20-8	16 - 16.9	20	25	131	50	203.10	204.07	200.84	16	DM*160 - DM*169
TID170F20-8	17 - 17.9	20	25	139	50	212.70	213.68	210.15	17	DM*170 - DM*179
TID180F25-8	18 - 18.9	25	32	147	56	228.30	229.35	225.45	18	DM*180 - DM*189
TID190F25-8	19 - 19.9	25	32	156	56	237.80	238.91	234.79	19	DM*190 - DM*199
TID200F25-8	20 - 20.9	25	32	164	56	247.40	248.62	245.12	20	DM*200 - DM*209
TID210F25-8	21 - 21.9	25	32	172	56	256.98	258.20	254.54	21	DM*210 - DM*219
TID220F25-8	22 - 22.9	25	32	180	56	266.56	267.84	263.86	22	DM*220 - DM*229
TID230F32-8	23 - 23.9	32	42	188	60	280.13	281.51	277.28	23	DM*230 - DM*239
TID240F32-8	24 - 24.9	32	42	196	60	289.70	291.11	286.71	24	DM*240 - DM*249
TID250F32-8	25 - 25.9	32	42	205	60	299.30	300.78	296.15	25	DM*250 - DM*259

Tool diameter	Hole diameter tolerance*
ø7 - ø17.9	+0.05 / 0
ø18 - ø25.9	+0.055 / 0

- An overall length (OAL) differs based on each head geometry.
 - For drill diameters from ø8 mm - ø9.9 mm, the drill shoulder to shank bottom distance when a DMC drill head is mounted is 0.3 mm shorter when compared with a DMP head of the equivalent sizes. The distances are the same for the DMC and DMP drill heads in other diameters than the above.

*Just for reference

New

TID-R-2E L/D=2

Head changeable drill (For external coolant supply)

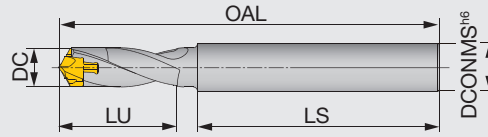

* Cylindrical shank

Designation	DC	DCONMS	LU	LS	OAL			Pocket size	Head
					DMP	DMC	DMF		
TID060R8-2E	6 - 6.4	8	12.4	45	66.1	66.2	65.2	6	DM*060 - DM*064
TID065R8-2E	6.5 - 6.9	8	12.8	45	67.2	67.3	66.3	6.5	DM*065 - DM*069
TID070R8-2E	7 - 7.4	8	13.3	45	68	68.4	67.1	7	DM*070 - DM*074
TID075R8-2E	7.5 - 7.9	8	14.4	45	69	69.4	68.1	7	DM*075 - DM*079
TID080R10-2E	8 - 8.9	10	14.7	50	75.2	75.3	74.3	8	DM*080 - DM*089
TID090R10-2E	9 - 9.9	10	16.5	50	77.4	77.5	76.3	9	DM*090 - DM*099
TID100R12-2E	10 - 10.9	12	22.2	60	94.3	94.9	92.9	10	DM*100 - DM*109
TID110R12-2E	11 - 11.9	12	24	60	96.5	97.1	94.9	11	DM*110 - DM*119
TID120R14-2E	12 - 12.9	14	25.8	65	103.6	104.2	102.0	12	DM*120 - DM*129
TID130R14-2E	13 - 13.9	14	27.4	65	108.8	109.6	106.9	13	DM*130 - DM*139
TID140R16-2E	14 - 14.9	16	29	70	115	115.8	113.0	14	DM*140 - DM*149
TID150R16-2E	15 - 15.9	16	31.5	70	118	118.9	115.9	15	DM*150 - DM*159
TID160R18-2E	16 - 16.9	18	33.1	70	122.2	123.2	119.9	16	DM*160 - DM*169

Tool diameter	Hole diameter tolerance*
ø6 - ø16.9	+0.04 / 0

*Just for reference

- An overall length (OAL) differs based on each head geometry.
- When using the drill at a higher feed rate, make sure to provide an axial support by placing the overhang adjusting screw at the drill shank end in the tool holder. This will prevent high thrust force from pushing the drill back into the holder during drilling.
- When axially adjusting the shank inside the holder to obtain a required drill overhang, make sure the shank length remaining inside the holder does not come short of the minimum clamping length (LSCN) specified by the holder supplier.
- For drill diameters from ø8 mm - ø9.9 mm, the drill shoulder to shank bottom distance when a DMC drill head is mounted is 0.3 mm shorter when compared with a DMP head of the equivalent sizes. The distances are the same for the DMC and DMP drill heads in other diameters than the above.

TID-R L/D=3.5

Head changeable drill

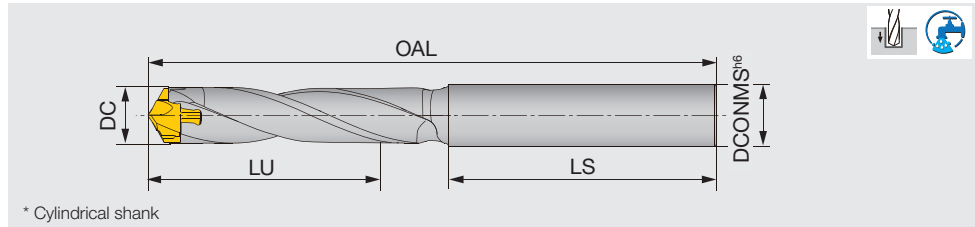

Designation	DC	DCONMS	LU	LS	OAL			Pocket size	Head
					DMP/H/N	DMC	DMF		
TID060R8-3.5	6 - 6.4	8	21	45	75.64	75.79	74.8	6	DM*060 - DM*064
TID065R8-3.5	6.5 - 6.9	8	22.75	45	77.48	77.63	76.61	6.5	DM*065 - DM*069
TID070R8-3.5	7 - 7.4	8	24.5	45	79.08	79.53	78.21	7	DM*070 - DM*074
TID075R8-3.5	7.5 - 7.9	8	26.25	45	80.83	81.28	79.96	7	DM*075 - DM*079
TID080R10-3.5	8 - 8.4	10	28	50	87.75	87.9	86.89	8	DM*080 - DM*084
TID085R10-3.5	8.5 - 8.9	10	29.75	50	89.5	89.65	88.64	8	DM*085 - DM*089
TID090R10-3.5	9 - 9.4	10	31.5	50	91.42	91.57	90.38	9	DM*090 - DM*094
TID095R10-3.5	9.5 - 9.9	10	33.25	50	93.17	93.32	92.13	9	DM*095 - DM*099
TID100R12-3.5	10 - 10.4	12	42	60	114.03	114.65	112.7	10	DM*100 - DM*104
TID105R12-3.5	10.5 - 10.9	12	44	60	115.69	116.31	114.36	10	DM*105 - DM*109
TID110R12-3.5	11 - 11.4	12	46	65	123.13	123.78	121.58	11	DM*110 - DM*114
TID115R12-3.5	11.5 - 11.9	12	48	65	124.79	125.44	123.24	11	DM*115 - DM*119
TID120R14-3.5	12 - 12.4	14	50	65	127.18	127.81	125.59	12	DM*120 - DM*124
TID125R14-3.5	12.5 - 12.9	14	52	65	128.84	129.47	127.25	12	DM*125 - DM*129
TID130R14-3.5	13 - 13.4	14	54	65	132.74	133.49	130.87	13	DM*130 - DM*134
TID135R14-3.5	13.5 - 13.9	14	56	65	134.4	135.15	132.53	13	DM*135 - DM*139
TID140R16-3.5	14 - 14.4	16	58	70	142.18	142.99	140.19	14	DM*140 - DM*144
TID145R16-3.5	14.5 - 14.9	16	60	70	143.84	144.65	141.85	14	DM*145 - DM*149
TID150R16-3.5	15 - 15.9	16	64	70	148.44	149.35	146.34	15	DM*150 - DM*159
TID160R18-3.5	16 - 16.9	18	68	70	153.93	154.9	151.67	16	DM*160 - DM*169
TID170R18-3.5	17 - 17.9	18	72	70	158.46	159.44	155.91	17	DM*170 - DM*179
TID180R20-3.5	18 - 18.9	20	76	70	164.02	165.07	161.17	18	DM*180 - DM*189
TID190R20-3.5	19 - 19.9	20	80	70	168.37	169.48	165.36	19	DM*190 - DM*199

Tool diameter	Hole diameter tolerance*
ø6 - ø19.9	+0.04 / 0

*Just for reference

- An overall length (OAL) differs based on each head geometry.
- When using the drill at a higher feed rate, make sure to provide an axial support by placing the overhang adjusting screw at the drill shank end in the tool holder. This will prevent high thrust force from pushing the drill back into the holder during drilling.
- When axially adjusting the shank inside the holder to obtain a required drill overhang, make sure the shank length remaining inside the holder does not come short of the minimum clamping length (LSCN) specified by the holder supplier.
- For drill diameters from ø8 mm - ø9.9 mm, the drill shoulder to shank bottom distance when a DMC drill head is mounted is 0.3 mm shorter when compared with a DMP head of the equivalent sizes. The distances are the same for the DMC and DMP drill heads in other diameters than the above.

TID-R L/D=6

Head changeable drill

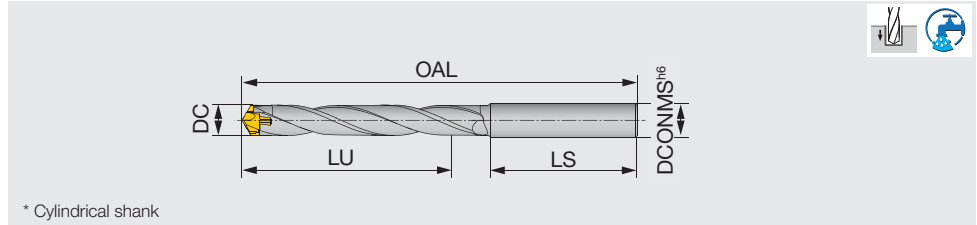

Designation	DC	DCONMS	LU	LS	OAL			Pocket size	Head
					DMP/H/N	DMC	DMF		
TID060R8-6	6 - 6.4	8	36	45	91.64	91.79	90.8	6	DM*060 - DM*064
TID065R8-6	6.5 - 6.9	8	39	45	94.73	94.88	93.86	6.5	DM*065 - DM*069
TID070R8-6	7 - 7.4	8	42	45	97.58	98.03	96.71	7	DM*070 - DM*074
TID075R8-6	7.5 - 7.9	8	45	45	100.58	101.03	99.71	7	DM*075 - DM*079
TID080R10-6	8 - 8.4	10	48	50	108.75	108.9	107.89	8	DM*080 - DM*084
TID085R10-6	8.5 - 8.9	10	51	50	111.75	111.9	110.89	8	DM*085 - DM*089
TID090R10-6	9 - 9.4	10	54	50	114.92	115.07	113.88	9	DM*090 - DM*094
TID095R10-6	9.5 - 9.9	10	57	50	117.92	118.07	116.88	9	DM*095 - DM*099
TID100R12-6	10 - 10.4	12	68	60	140.03	140.65	138.7	10	DM*100 - DM*104
TID105R12-6	10.5 - 10.9	12	71	60	142.94	143.56	141.61	10	DM*105 - DM*109
TID110R12-6	11 - 11.4	12	75	65	151.63	152.28	150.08	11	DM*110 - DM*114
TID115R12-6	11.5 - 11.9	12	78	65	154.54	155.19	152.99	11	DM*115 - DM*119
TID120R14-6	12 - 12.4	14	81	65	158.18	158.81	156.59	12	DM*120 - DM*124
TID125R14-6	12.5 - 12.9	14	84	65	161.09	161.72	159.5	12	DM*125 - DM*129
TID130R14-6	13 - 13.4	14	88	65	166.24	166.99	164.37	13	DM*130 - DM*134
TID135R14-6	13.5 - 13.9	14	91	65	169.15	169.9	167.28	13	DM*135 - DM*139
TID140R16-6	14 - 14.4	16	94	70	178.18	178.99	176.19	14	DM*140 - DM*144
TID145R16-6	14.5 - 14.9	16	97	70	181.09	181.9	179.1	14	DM*145 - DM*149
TID150R16-6	15 - 15.9	16	104	70	188.19	189.1	186.09	15	DM*150 - DM*159
TID160R18-6	16 - 16.9	18	110	70	196.18	197.15	193.92	16	DM*160 - DM*169
TID170R18-6	17 - 17.9	18	117	70	203.21	204.19	200.66	17	DM*170 - DM*179
TID180R20-6	18 - 18.9	20	124	70	211.27	212.32	208.42	18	DM*180 - DM*189
TID190R20-6	19 - 19.9	20	130	70	218.12	219.23	215.11	19	DM*190 - DM*199

Tool diameter	Hole diameter tolerance*
ø6 - ø17.9	+0.05 / 0
ø18 - ø19.9	+0.055 / 0

*Just for reference

- An overall length (OAL) differs based on each head geometry.
- When using the drill at a higher feed rate, make sure to provide an axial support by placing the overhang adjusting screw at the drill shank end in the tool holder. This will prevent high thrust force from pushing the drill back into the holder during drilling.
- When axially adjusting the shank inside the holder to obtain a required drill overhang, make sure the shank length remaining inside the holder does not come short of the minimum clamping length (LSCN) specified by the holder supplier.
- For drill diameters from ø8 mm - ø9.9 mm, the drill shoulder to shank bottom distance when a DMC drill head is mounted is 0.3 mm shorter when compared with a DMP head of the equivalent sizes. The distances are the same for the DMC and DMP drill heads in other diameters than the above.

TID-R L/D=8

Head changeable drill

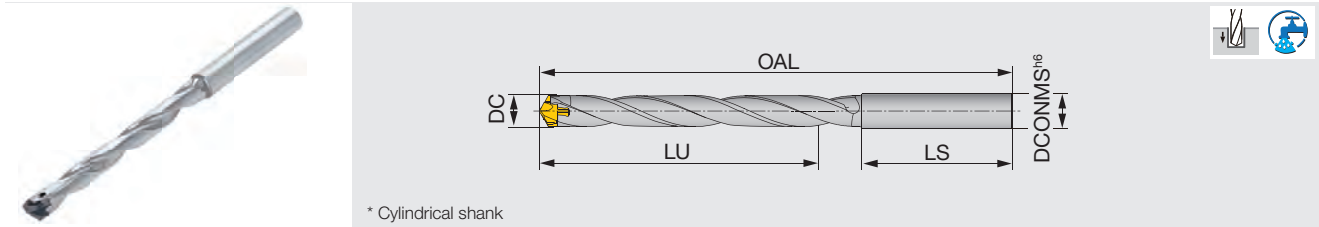

Designation	DC	DCONMS	LU	LS	OAL			Pocket size	Head
					DMP/H/N	DMC	DMF		
TID060R8-8	6 - 6.4	8	48	45	104.44	104.59	103.6	6	DM*060 - DM*064
TID065R8-8	6.5 - 6.9	8	52	45	108.53	108.68	107.66	6.5	DM*065 - DM*069
TID070R8-8	7 - 7.4	8	56	45	112.38	112.83	111.51	7	DM*070 - DM*074
TID075R8-8	7.5 - 7.9	8	60	45	116.38	116.83	115.51	7	DM*075 - DM*079
TID080R10-8	8 - 8.4	10	64	50	125.55	125.7	124.69	8	DM*080 - DM*084
TID085R10-8	8.5 - 8.9	10	68	50	129.55	129.7	128.69	8	DM*085 - DM*089
TID090R10-8	9 - 9.4	10	72	50	133.72	133.87	132.68	9	DM*090 - DM*094
TID095R10-8	9.5 - 9.9	10	76	50	137.72	137.87	136.68	9	DM*095 - DM*099
TID100R12-8	10 - 10.4	12	89	60	160.83	161.45	159.5	10	DM*100 - DM*104
TID105R12-8	10.5 - 10.9	12	93	60	164.74	165.36	163.41	10	DM*105 - DM*109
TID110R12-8	11 - 11.4	12	98	65	174.43	175.08	172.88	11	DM*110 - DM*114
TID115R12-8	11.5 - 11.9	12	102	65	178.34	178.99	176.79	11	DM*115 - DM*119
TID120R14-8	12 - 12.4	14	106	65	182.98	183.61	181.39	12	DM*120 - DM*124
TID125R14-8	12.5 - 12.9	14	110	65	186.89	187.52	185.3	12	DM*125 - DM*129
TID130R14-8	13 - 13.4	14	115	65	193.04	193.79	191.17	13	DM*130 - DM*134
TID135R14-8	13.5 - 13.9	14	119	65	196.9	197.65	195.03	13	DM*135 - DM*139
TID140R16-8	14 - 14.4	16	123	70	206.98	207.79	204.99	14	DM*140 - DM*144
TID145R16-8	14.5 - 14.9	16	127	70	210.89	211.7	208.9	14	DM*145 - DM*149
TID150R16-8	15 - 15.9	16	136	70	219.99	220.9	217.89	15	DM*150 - DM*159
TID160R18-8	16 - 16.9	18	144	70	229.98	230.95	227.72	16	DM*160 - DM*169
TID170R18-8	17 - 17.9	18	153	70	239.01	239.99	236.46	17	DM*170 - DM*179
TID180R20-8	18 - 18.9	20	162	70	249.07	250.12	246.22	18	DM*180 - DM*189
TID190R20-8	19 - 19.9	20	170	70	257.92	259.03	254.91	19	DM*190 - DM*199

Tool diameter	Hole diameter tolerance*
ø6 - ø17.9	+0.05 / 0
ø18 - ø19.9	+0.055 / 0

*Just for reference

- An overall length (OAL) differs based on each head geometry.
- When using the drill at a higher feed rate, make sure to provide an axial support by placing the overhang adjusting screw at the drill shank end in the tool holder. This will prevent high thrust force from pushing the drill back into the holder during drilling.
- When axially adjusting the shank inside the holder to obtain a required drill overhang, make sure the shank length remaining inside the holder does not come short of the minimum clamping length (LSCN) specified by the holder supplier.
- For drill diameters from ø8 mm - ø9.9 mm, the drill shoulder to shank bottom distance when a DMC drill head is mounted is 0.3 mm shorter when compared with a DMP head of the equivalent sizes. The distances are the same for the DMC and DMP drill heads in other diameters than the above.

TID-R L/D=12

Head changeable drill

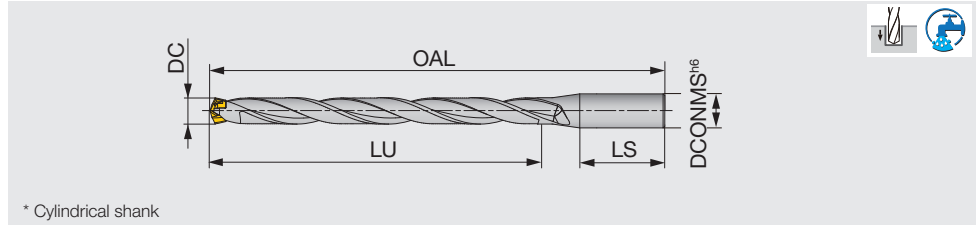

Designation	DC	DCONMS	LU	LS	OAL			Pocket size	Head
					DMP/H/N	DMC	DMF		
TID080R12-12	8 - 8.4	12	98	45	156.25	156.4	155.39	8	DM*080 - DM*084
TID085R12-12	8.5 - 8.9	12	104	45	162.25	162.4	161.39	8	DM*085 - DM*089
TID090R12-12	9 - 9.4	12	110	45	168.65	168.8	167.61	9	DM*090 - DM*094
TID095R12-12	9.5 - 9.9	12	116	45	174.65	174.8	173.61	9	DM*095 - DM*099
TID100R16-12	10 - 10.4	16	122	48	184.05	184.67	182.72	10	DM*100 - DM*104
TID105R16-12	10.5 - 10.9	16	128	48	190.05	190.67	188.72	10	DM*105 - DM*109
TID110R16-12	11 - 11.4	16	134	48	196.45	197.1	194.9	11	DM*110 - DM*114
TID115R16-12	11.5 - 11.9	16	140	48	202.45	203.1	200.9	11	DM*115 - DM*119
TID120R16-12	12 - 12.4	16	146	48	208.8	209.43	207.21	12	DM*120 - DM*124
TID125R16-12	12.5 - 12.9	16	152	48	214.8	215.43	213.21	12	DM*125 - DM*129
TID130R16-12	13 - 13.4	16	158	48	221.4	222.15	219.53	13	DM*130 - DM*134
TID135R16-12	13.5 - 13.9	16	165	48	227.4	228.15	225.53	13	DM*135 - DM*139
TID140R16-12	14 - 14.4	16	171	48	235.95	236.76	233.96	14	DM*140 - DM*144
TID145R16-12	14.5 - 14.9	16	177	48	241.95	242.76	239.96	14	DM*145 - DM*149
TID150R20-12	15 - 15.9	20	183	50	253.53	254.44	251.43	15	DM*150 - DM*159
TID160R20-12	16 - 16.9	20	195	50	267.1	268.07	264.84	16	DM*160 - DM*169
TID170R20-12	17 - 17.9	20	207	50	280.7	281.68	278.15	17	DM*170 - DM*179
TID180R25-12	18 - 18.9	25	219	56	300.3	301.35	297.45	18	DM*180 - DM*189
TID190R25-12	19 - 19.9	25	232	56	313.8	314.91	310.79	19	DM*190 - DM*199
TID200R25-12	20 - 20.9	25	244	56	327.4	328.62	325.12	20	DM*200 - DM*209
TID210R25-12	21 - 21.9	25	256	56	340.98	342.2	338.54	21	DM*210 - DM*219
TID220R25-12	22 - 22.9	25	267	56	354.56	355.84	351.86	22	DM*220 - DM*229
TID230R32-12	23 - 23.9	32	276	60	372.13	373.51	369.28	23	DM*230 - DM*239
TID240R32-12	24 - 24.9	32	288	60	385.7	387.11	382.71	24	DM*240 - DM*249
TID250R32-12	25 - 25.9	32	300	60	399.3	400.78	396.15	25	DM*250 - DM*259

Tool diameter	Hole diameter tolerance*
ø8 - ø17.9	+0.05 / 0
ø18 - ø25.9	+0.055 / 0

*Just for reference

- An overall length (OAL) differs based on each head geometry.
- When using the drill at a higher feed rate, make sure to provide an axial support by placing the overhang adjusting screw at the drill shank end in the tool holder. This will prevent high thrust force from pushing the drill back into the holder during drilling.
- For drill diameters from ø8 mm - ø9.9 mm, the drill shoulder to shank bottom distance when a DMC drill head is mounted is 0.3 mm shorter when compared with a DMP head of the equivalent sizes. The distances are the same for the DMC and DMP drill heads in other diameters than the above.

Scan this QR code to find out other drill body information.



DRILL HEAD

DMP General purpose

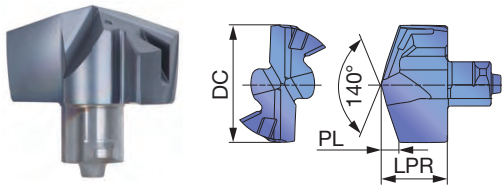

Tool diameter	Head diameter tolerance
ø6 - ø17.9	+0.018 / 0
ø18 - ø25.9	+0.021 / 0

P	Steel	☆	★
M	Stainless	★	☆
K	Cast iron	★	☆
N	Non-ferrous	☆	☆
S	Superalloys	★	☆
H	Hard materials	★	☆

P	Steel	☆	★
M	Stainless	★	☆
K	Cast iron	★	☆
N	Non-ferrous	☆	☆
S	Superalloys	★	☆
H	Hard materials	★	☆

★ : First choice
☆ : Second choice

Designation	DC	LPR	Coated		PL	Body
			AH725	AH9130		
DMP060	6	3.85	●		1.09	TID*060...
DMP061	6.1	3.85	●		1.11	TID*060...
DMP062	6.2	3.85	●		1.13	TID*060...
DMP063	6.3	3.85	●		1.14	TID*060...
DMP064	6.4	3.85	●		1.16	TID*060...
DMP065	6.5	4.15	●		1.27	TID*065...
DMP066	6.6	4.15	●		1.29	TID*065...
DMP067	6.7	4.15	●		1.31	TID*065...
DMP068	6.8	4.15	●	●	1.33	TID*065...
DMP069	6.9	4.15	●		1.34	TID*065...
DMP070	7	4.45	●		1.03	TID*070...
DMP071	7.1	4.45	●		1.05	TID*070...
DMP072	7.2	4.45	●		1.07	TID*070...
DMP073	7.3	4.45	●		1.08	TID*070...
DMP074	7.4	4.45	●		1.1	TID*070...
DMP075	7.5	4.45	●	●	1.12	TID*075...
DMP076	7.6	4.45	●		1.14	TID*075...
DMP077	7.7	4.45	●		1.16	TID*075...
DMP078	7.8	4.45	●		1.18	TID*075...
DMP079	7.9	4.45	●		1.19	TID*075...
DMP080	8	5.25	●	●	1.2	TID*080...
DMP081	8.1	5.25	●		1.22	TID*080...
DMP082	8.2	5.25	●		1.24	TID*080...
DMP083	8.3	5.25	●		1.25	TID*080...
DMP084	8.4	5.25	●		1.27	TID*080...
DMP085	8.5	5.25	●	●	1.29	TID*085...
DMP086	8.6	5.25	●		1.31	TID*085...
DMP087	8.7	5.25	●		1.33	TID*085...
DMP088	8.8	5.25	●		1.35	TID*085...
DMP089	8.9	5.25	●		1.36	TID*085...
DMP090	9	5.65	●	●	1.37	TID*090...
DMP091	9.1	5.65	●		1.39	TID*090...
DMP092	9.2	5.65	●		1.41	TID*090...
DMP093	9.3	5.65	●		1.42	TID*090...
DMP094	9.4	5.65	●		1.44	TID*090...
DMP095	9.5	5.65	●	●	1.46	TID*095...
DMP096	9.6	5.65	●		1.48	TID*095...
DMP097	9.7	5.65	●		1.5	TID*095...
DMP098	9.8	5.65	●		1.52	TID*095...

Designation	DC	LPR	Coated		PL	Body
			AH725	AH9130		
DMP099	9.9	5.65	●		1.53	TID*095...
DMP100	10	6.05	●	●	1.47	TID*100...
DMP101	10.1	6.05	●		1.49	TID*100...
DMP102	10.2	6.05	●		1.51	TID*100...
DMP103	10.3	6.05	●	●	1.52	TID*100...
DMP104	10.4	6.05	●	●	1.54	TID*100...
DMP105	10.5	6.05	●	●	1.56	TID*105...
DMP106	10.6	6.05	●	●	1.58	TID*105...
DMP107	10.7	6.05	●		1.6	TID*105...
DMP108	10.8	6.05	●	●	1.62	TID*105...
DMP109	10.9	6.05	●		1.63	TID*105...
DMP110	11	6.45	●	●	1.67	TID*110...
DMP111	11.1	6.45	●	●	1.69	TID*110...
DMP112	11.2	6.45	●	●	1.71	TID*110...
DMP113	11.3	6.45	●	●	1.72	TID*110...
DMP114	11.4	6.45	●		1.74	TID*110...
DMP115	11.5	6.45	●	●	1.76	TID*115...
DMP116	11.6	6.45	●		1.78	TID*115...
DMP117	11.7	6.45	●	●	1.8	TID*115...
DMP118	11.8	6.45	●		1.82	TID*115...
DMP119	11.9	6.45	●		1.83	TID*115...
DMP120	12	6.8	●	●	1.82	TID*120...
DMP121	12.1	6.8	●	●	1.84	TID*120...
DMP122	12.2	6.8	●	●	1.86	TID*120...
DMP123	12.3	6.8	●	●	1.87	TID*120...
DMP124	12.4	6.8	●	●	1.89	TID*120...
DMP125	12.5	6.8	●	●	1.91	TID*125...
DMP126	12.6	6.8	●	●	1.93	TID*125...
DMP127	12.7	6.8	●	●	1.95	TID*125...
DMP128	12.8	6.8	●	●	1.97	TID*125...
DMP129	12.9	6.8	●		1.98	TID*125...
DMP130	13	7.4	●	●	1.96	TID*130...
DMP131	13.1	7.4	●		1.98	TID*130...
DMP132	13.2	7.4	●		2	TID*130...
DMP133	13.3	7.4	●	●	2.01	TID*130...
DMP134	13.4	7.4	●		2.03	TID*130...
DMP135	13.5	7.4	●	●	2.05	TID*135...
DMP136	13.6	7.4	●		2.07	TID*135...
DMP137	13.7	7.4	●	●	2.09	TID*135...

ø6 - ø19.9 = 2 pieces per package
ø20 - ø25.9 = 1 piece per package

*Will be released in December 2021

● : Line-up

DMP General purpose

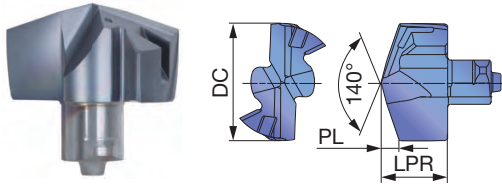

Tool diameter	Head diameter tolerance
ø6 - ø17.9	+0.018 / 0
ø18 - ø25.9	+0.021 / 0

	P Steel	M Stainless	K Cast iron	N Non-ferrous	S Superalloys	H Hard materials
☆	☆	★	★	☆	★	★
★	★	☆	☆	★	☆	☆

	P Steel	M Stainless	K Cast iron	N Non-ferrous	S Superalloys	H Hard materials
☆	☆	★	★	☆	★	★
★	★	☆	☆	★	☆	☆

★ : First choice
☆ : Second choice

Designation	DC	LPR	Coated		PL	Body
			AH725	AH9130		
DMP138	13.8	7.4	●	●	2.11	TID*135...
DMP139	13.9	7.4	●	●	2.12	TID*135...
DMP140	14	7.95	●	●	2.12	TID*140...
DMP141	14.1	7.95	●	●	2.14	TID*140...
DMP142	14.2	7.95	●	●	2.16	TID*140...
DMP143	14.3	7.95	●	●	2.17	TID*140...
DMP144	14.4	7.95	●	●	2.19	TID*140...
DMP145	14.5	7.95	●	●	2.21	TID*145...
DMP146	14.6	7.95	●	●	2.23	TID*145...
DMP147	14.7	7.95	●	●	2.25	TID*145...
DMP148	14.8	7.95	●	●	2.27	TID*145...
DMP149	14.9	7.95	●	●	2.28	TID*145...
DMP150	15	8.53	●	●	2.27	TID*150...
DMP151	15.1	8.53	●	●	2.29	TID*150...
DMP152	15.2	8.53	●	●	2.31	TID*150...
DMP153	15.3	8.53	●	●	2.32	TID*150...
DMP154	15.4	8.53	●	●	2.34	TID*150...
DMP155	15.5	8.53	●	●	2.36	TID*150...
DMP156	15.6	8.53	●	●	2.38	TID*150...
DMP157	15.7	8.53	●	●	2.4	TID*150...
DMP158	15.8	8.53	●	●	2.42	TID*150...
DMP159	15.9	8.53	●	●	2.43	TID*150...
DMP160	16	9.1	●	●	2.42	TID*160...
DMP161	16.1	9.1	●	●	2.44	TID*160...
DMP162	16.2	9.1	●	●	2.46	TID*160...
DMP163	16.3	9.1	●	●	2.47	TID*160...
DMP164	16.4	9.1	●	●	2.49	TID*160...
DMP165	16.5	9.1	●	●	2.51	TID*160...
DMP166	16.6	9.1	●	●	2.53	TID*160...
DMP167	16.7	9.1	●	●	2.55	TID*160...
DMP168	16.8	9.1	●	●	2.57	TID*160...
DMP169	16.9	9.1	●	●	2.58	TID*160...
DMP170	17	9.7	●	●	2.59	TID*170...
DMP171	17.1	9.7	●	●	2.61	TID*170...
DMP172	17.2	9.7	●	●	2.63	TID*170...
DMP173	17.3	9.7	●	●	2.64	TID*170...
DMP174	17.4	9.7	●	●	2.66	TID*170...
DMP175	17.5	9.7	●	●	2.68	TID*170...
DMP176	17.6	9.7	●	●	2.7	TID*170...
DMP177	17.7	9.7	●	●	2.72	TID*170...
DMP178	17.8	9.7	●	●	2.74	TID*170...
DMP179	17.9	9.7	●	●	2.75	TID*170...

Designation	DC	LPR	Coated		PL	Body
			AH725	AH9130		
DMP180	18	10.3	●	●	2.73	TID*180...
DMP181	18.1	10.3	●	●	2.75	TID*180...
DMP182	18.2	10.3	●	●	2.77	TID*180...
DMP183	18.3	10.3	●	●	2.78	TID*180...
DMP184	18.4	10.3	●	●	2.8	TID*180...
DMP185	18.5	10.3	●	●	2.82	TID*180...
DMP186	18.6	10.3	●	●	2.84	TID*180...
DMP187	18.7	10.3	●	●	2.86	TID*180...
DMP188	18.8	10.3	●	●	2.88	TID*180...
DMP189	18.9	10.3	●	●	2.89	TID*180...
DMP190	19	10.8	●	●	2.88	TID*190...
DMP1905	19.05	10.8	●	●	2.89	TID*190...
DMP191	19.1	10.8	●	●	2.9	TID*190...
DMP192	19.2	10.8	●	●	2.92	TID*190...
DMP1927	19.27	10.8	●	●	2.93	TID*190...
DMP193	19.3	10.8	●	●	2.93	TID*190...
DMP194	19.4	10.8	●	●	2.95	TID*190...
DMP195	19.5	10.8	●	●	2.97	TID*190...
DMP196	19.6	10.8	●	●	2.99	TID*190...
DMP197	19.7	10.8	●	●	3.01	TID*190...
DMP198	19.8	10.8	●	●	3.03	TID*190...
DMP199	19.9	10.8	●	●	3.04	TID*190...
DMP200	20	11.4	●	●	3.02	TID*200...
DMP201	20.1	11.4	●	●	3.04	TID*200...
DMP202	20.2	11.4	●	●	3.06	TID*200...
DMP203	20.3	11.4	●	●	3.07	TID*200...
DMP204	20.4	11.4	●	●	3.09	TID*200...
DMP205	20.5	11.4	●	●	3.11	TID*200...
DMP206	20.6	11.4	●	●	3.13	TID*200...
DMP207	20.7	11.4	●	●	3.15	TID*200...
DMP208	20.8	11.4	●	●	3.17	TID*200...
DMP209	20.9	11.4	●	●	3.18	TID*200...
DMP210	21	11.98	●	●	3.18	TID*210...
DMP211	21.1	11.98	●	●	3.2	TID*210...
DMP212	21.2	11.98	●	●	3.22	TID*210...
DMP213	21.3	11.98	●	●	3.23	TID*210...
DMP214	21.4	11.98	●	●	3.25	TID*210...
DMP215	21.5	11.98	●	●	3.27	TID*210...
DMP216	21.6	11.98	●	●	3.29	TID*210...
DMP217	21.7	11.98	●	●	3.31	TID*210...
DMP218	21.8	11.98	●	●	3.33	TID*210...
DMP219	21.9	11.98	●	●	3.34	TID*210...

ø6 - ø19.9 = 2 pieces per package
ø20 - ø25.9 = 1 piece per package

● : Line-up

P	Steel	☆	★
M	Stainless	★	☆
K	Cast iron	★	☆
N	Non-ferrous	☆	☆
S	Superalloys	★	☆
H	Hard materials	★	☆

★ : First choice
☆ : Second choice

Designation	DC	LPR	Coated		PL	Body
			AH725	AH9130		
DMP220	22	12.56	●	●	3.32	TID*220...
DMP221	22.1	12.56	●		3.34	TID*220...
DMP222	22.2	12.56	●		3.36	TID*220...
DMP223	22.3	12.56	●	●	3.37	TID*220...
DMP224	22.4	12.56	●		3.39	TID*220...
DMP225	22.5	12.56	●		3.41	TID*220...
DMP226	22.6	12.56	●		3.43	TID*220...
DMP227	22.7	12.56	●		3.45	TID*220...
DMP228	22.8	12.56	●		3.47	TID*220...
DMP229	22.9	12.56	●		3.48	TID*220...
DMP230	23	13.13	●		3.46	TID*230...
DMP231	23.1	13.13	●		3.48	TID*230...
DMP232	23.2	13.13	●		3.5	TID*230...
DMP233	23.3	13.13	●		3.51	TID*230...
DMP234	23.4	13.13	●		3.53	TID*230...
DMP235	23.5	13.13	●		3.55	TID*230...
DMP236	23.6	13.13	●		3.57	TID*230...
DMP237	23.7	13.13	●		3.59	TID*230...
DMP238	23.8	13.13	●		3.61	TID*230...
DMP239	23.9	13.13	●		3.62	TID*230...
DMP240	24	13.7	●	●	3.62	TID*240...
DMP241	24.1	13.7	●		3.64	TID*240...
DMP242	24.2	13.7	●		3.66	TID*240...
DMP243	24.3	13.7	●		3.67	TID*240...
DMP244	24.4	13.7	●		3.69	TID*240...
DMP245	24.5	13.7	●		3.71	TID*240...
DMP246	24.6	13.7	●		3.73	TID*240...
DMP247	24.7	13.7	●		3.75	TID*240...
DMP248	24.8	13.7	●		3.77	TID*240...
DMP249	24.9	13.7	●		3.78	TID*240...
DMP250	25	14.3	●	●	3.8	TID*250...
DMP251	25.1	14.3	●		3.82	TID*250...
DMP252	25.2	14.3	●		3.84	TID*250...
DMP253	25.3	14.3	●		3.85	TID*250...
DMP254	25.4	14.3	●		3.87	TID*250...
DMP255	25.5	14.3	●		3.89	TID*250...
DMP256	25.6	14.3	●		3.91	TID*250...
DMP2567	25.67	14.3	●		3.92	TID*250...
DMP257	25.7	14.3	●		3.93	TID*250...
DMP258	25.8	14.3	●		3.95	TID*250...
DMP259	25.9	14.3	●	●	3.96	TID*250...

ø6 - ø19.9 = 2 pieces per package
ø20 - ø25.9 = 1 piece per package

● : Line-up

DMC High precision drilling

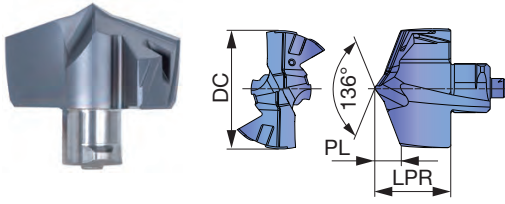

Tool diameter	Head diameter tolerance
ø6 - ø17.9	+0.018 / 0
ø18 - ø25.9	+0.021 / 0

P	Steel	★		
M	Stainless	★		
K	Cast iron	★		
N	Non-ferrous	☆		
S	Superalloys	★		
H	Hard materials	★		

P	Steel	★		
M	Stainless	★		
K	Cast iron	★		
N	Non-ferrous	☆		
S	Superalloys	★		
H	Hard materials	★		

★ : First choice
☆ : Second choice

Designation	DC	LPR	Coated		PL	Body
			AH9130			
DMC060	6	4	●		1.24	TID*060...
DMC061	6.1	4	●		1.26	TID*060...
DMC062	6.2	4	●		1.28	TID*060...
DMC063	6.3	4	●		1.3	TID*060...
DMC064	6.4	4	●		1.32	TID*060...
DMC065	6.5	4.3	●		1.33	TID*065...
DMC066	6.6	4.3	●		1.35	TID*065...
DMC067	6.7	4.3	●		1.37	TID*065...
DMC068	6.8	4.3	●		1.39	TID*065...
DMC069	6.9	4.3	●		1.41	TID*065...
DMC070	7	4.9	●		1.48	TID*070...
DMC071	7.1	4.9	●		1.5	TID*070...
DMC072	7.2	4.9	●		1.52	TID*070...
DMC073	7.3	4.9	●		1.54	TID*070...
DMC074	7.4	4.9	●		1.56	TID*070...
DMC075	7.5	4.9	●		1.58	TID*075...
DMC076	7.6	4.9	●		1.6	TID*075...
DMC077	7.7	4.9	●		1.62	TID*075...
DMC078	7.8	4.9	●		1.64	TID*075...
DMC079	7.9	4.9	●		1.66	TID*075...
DMC080	8	5.4	●		1.62	TID*080...
DMC081	8.1	5.4	●		1.64	TID*080...
DMC082	8.2	5.4	●		1.66	TID*080...
DMC083	8.3	5.4	●		1.68	TID*080...
DMC084	8.4	5.4	●		1.7	TID*080...
DMC085	8.5	5.4	●		1.72	TID*085...
DMC086	8.6	5.4	●		1.74	TID*085...
DMC087	8.7	5.4	●		1.76	TID*085...
DMC088	8.8	5.4	●		1.78	TID*085...
DMC089	8.9	5.4	●		1.8	TID*085...
DMC090	9	5.8	●		1.91	TID*090...
DMC091	9.1	5.8	●		1.93	TID*090...
DMC092	9.2	5.8	●		1.95	TID*090...
DMC093	9.3	5.8	●		1.97	TID*090...
DMC094	9.4	5.8	●		1.99	TID*090...
DMC095	9.5	5.8	●		2.01	TID*095...
DMC096	9.6	5.8	●		2.03	TID*095...
DMC097	9.7	5.8	●		2.05	TID*095...
DMC098	9.8	5.8	●		2.07	TID*095...
DMC099	9.9	5.8	●		2.09	TID*095...
DMC100	10	6.67	●		2.09	TID*100...
DMC101	10.1	6.67	●		2.11	TID*100...

Designation	DC	LPR	Coated		PL	Body
			AH9130			
DMC102	10.2	6.67	●		2.13	TID*100...
DMC103	10.3	6.67	●		2.15	TID*100...
DMC104	10.4	6.67	●		2.17	TID*100...
DMC105	10.5	6.67	●		2.19	TID*105...
DMC106	10.6	6.67	●		2.21	TID*105...
DMC107	10.7	6.67	●		2.23	TID*105...
DMC108	10.8	6.67	●		2.25	TID*105...
DMC109	10.9	6.67	●		2.27	TID*105...
DMC110	11	7.1	●		2.32	TID*110...
DMC111	11.1	7.1	●		2.34	TID*110...
DMC112	11.2	7.1	●		2.36	TID*110...
DMC113	11.3	7.1	●		2.38	TID*110...
DMC114	11.4	7.1	●		2.4	TID*110...
DMC115	11.5	7.1	●		2.42	TID*115...
DMC116	11.6	7.1	●		2.44	TID*115...
DMC117	11.7	7.1	●		2.46	TID*115...
DMC118	11.8	7.1	●		2.48	TID*115...
DMC119	11.9	7.1	●		2.5	TID*115...
DMC120	12	7.43	●		2.45	TID*120...
DMC121	12.1	7.43	●		2.47	TID*120...
DMC122	12.2	7.43	●		2.49	TID*120...
DMC123	12.3	7.43	●		2.51	TID*120...
DMC124	12.4	7.43	●		2.53	TID*120...
DMC125	12.5	7.43	●		2.55	TID*125...
DMC126	12.6	7.43	●		2.57	TID*125...
DMC127	12.7	7.43	●		2.59	TID*125...
DMC128	12.8	7.43	●		2.61	TID*125...
DMC129	12.9	7.43	●		2.63	TID*125...
DMC130	13	8.15	●		2.71	TID*130...
DMC131	13.1	8.15	●		2.73	TID*130...
DMC132	13.2	8.15	●		2.75	TID*130...
DMC133	13.3	8.15	●		2.77	TID*130...
DMC134	13.4	8.15	●		2.79	TID*130...
DMC135	13.5	8.15	●		2.81	TID*135...
DMC136	13.6	8.15	●		2.83	TID*135...
DMC137	13.7	8.15	●		2.85	TID*135...
DMC138	13.8	8.15	●		2.87	TID*135...
DMC139	13.9	8.15	●		2.89	TID*135...
DMC140	14	8.76	●		2.93	TID*140...
DMC141	14.1	8.76	●		2.95	TID*140...
DMC142	14.2	8.76	●		2.97	TID*140...
DMC143	14.3	8.76	●		2.99	TID*140...

ø6 - ø19.9 = 2 pieces per package
ø20 - ø25.9 = 1 piece per package

● : Line-up

P	Steel	★		
M	Stainless	★		
K	Cast iron	★		
N	Non-ferrous	☆		
S	Superalloys	★		
H	Hard materials	★		

P	Steel	★		
M	Stainless	★		
K	Cast iron	★		
N	Non-ferrous	☆		
S	Superalloys	★		
H	Hard materials	★		

★ : First choice
☆ : Second choice

Designation	DC	LPR	Coated		PL	Body
			AH9130			
DMC144	14.4	8.76	●		3.01	TID*140...
DMC145	14.5	8.76	●		3.03	TID*145...
DMC146	14.6	8.76	●		3.05	TID*145...
DMC147	14.7	8.76	●		3.07	TID*145...
DMC148	14.8	8.76	●		3.09	TID*145...
DMC149	14.9	8.76	●		3.11	TID*145...
DMC150	15	9.44	●		3.18	TID*150...
DMC151	15.1	9.44	●		3.2	TID*150...
DMC152	15.2	9.44	●		3.22	TID*150...
DMC153	15.3	9.44	●		3.24	TID*150...
DMC154	15.4	9.44	●		3.26	TID*150...
DMC155	15.5	9.44	●		3.28	TID*150...
DMC156	15.6	9.44	●		3.3	TID*150...
DMC157	15.7	9.44	●		3.32	TID*150...
DMC158	15.8	9.44	●		3.34	TID*150...
DMC159	15.9	9.44	●		3.36	TID*150...
DMC160	16	10.07	●		3.39	TID*160...
DMC161	16.1	10.07	●		3.41	TID*160...
DMC162	16.2	10.07	●		3.43	TID*160...
DMC163	16.3	10.07	●		3.45	TID*160...
DMC164	16.4	10.07	●		3.47	TID*160...
DMC165	16.5	10.07	●		3.49	TID*160...
DMC166	16.6	10.07	●		3.51	TID*160...
DMC167	16.7	10.07	●		3.53	TID*160...
DMC168	16.8	10.07	●		3.55	TID*160...
DMC169	16.9	10.07	●		3.57	TID*160...
DMC170	17	10.68	●		3.57	TID*170...
DMC171	17.1	10.68	●		3.59	TID*170...
DMC172	17.2	10.68	●		3.61	TID*170...
DMC173	17.3	10.68	●		3.63	TID*170...
DMC174	17.4	10.68	●		3.65	TID*170...
DMC175	17.5	10.68	●		3.67	TID*170...
DMC176	17.6	10.68	●		3.69	TID*170...
DMC177	17.7	10.68	●		3.71	TID*170...
DMC178	17.8	10.68	●		3.73	TID*170...
DMC179	17.9	10.68	●		3.75	TID*170...
DMC180	18	11.35	●		3.78	TID*180...
DMC181	18.1	11.35	●		3.8	TID*180...
DMC182	18.2	11.35	●		3.82	TID*180...

Designation	DC	LPR	Coated		PL	Body
			AH9130			
DMC183	18.3	11.35	●		3.84	TID*180...
DMC184	18.4	11.35	●		3.86	TID*180...
DMC185	18.5	11.35	●		3.88	TID*180...
DMC186	18.6	11.35	●		3.9	TID*180...
DMC187	18.7	11.35	●		3.92	TID*180...
DMC188	18.8	11.35	●		3.94	TID*180...
DMC189	18.9	11.35	●		3.96	TID*180...
DMC190	19	11.91	●		3.99	TID*190...
DMC191	19.1	11.91	●		4.01	TID*190...
DMC192	19.2	11.91	●		4.03	TID*190...
DMC1927	19.27	11.91	●		4.04	TID*190...
DMC193	19.3	11.91	●		4.05	TID*190...
DMC194	19.4	11.91	●		4.07	TID*190...
DMC195	19.5	11.91	●		4.09	TID*190...
DMC196	19.6	11.91	●		4.11	TID*190...
DMC197	19.7	11.91	●		4.13	TID*190...
DMC198	19.8	11.91	●		4.15	TID*190...
DMC199	19.9	11.91	●		4.17	TID*190...
DMC200	20	12.62	●		4.24	TID*200...
DMC201	20.1	12.62	●		4.26	TID*200...
DMC205	20.5	12.62	●		4.34	TID*200...
DMC206	20.6	12.62	●		4.36	TID*200...
DMC210	21	13.2	●		4.4	TID*210...
DMC211	21.1	13.2	●		4.42	TID*210...
DMC215	21.5	13.2	●		4.5	TID*210...
DMC217	21.7	13.2	●		4.54	TID*210...
DMC218	21.8	13.2	●		4.56	TID*210...
DMC220	22	13.84	●		4.6	TID*220...
DMC221	22.1	13.84	●		4.62	TID*220...
DMC222	22.2	13.84	●		4.64	TID*220...
DMC223	22.3	13.84	●		4.66	TID*220...
DMC225	22.5	13.84	●		4.7	TID*220...
DMC230	23	14.51	●		4.84	TID*230...
DMC235	23.5	14.51	●		4.94	TID*230...
DMC240	24	15.11	●		5.03	TID*240...
DMC245	24.5	15.11	●		5.13	TID*240...
DMC250	25	15.78	●		5.28	TID*250...
DMC253	25.3	15.78	●		5.34	TID*250...
DMC255	25.5	15.78	●		5.38	TID*250...
DMC2567	25.67	15.78	●		5.42	TID*250...
DMC259	25.9	15.78	●		5.46	TID*250...

ø6 - ø19.9 = 2 pieces per package
ø20 - ø25.9 = 1 piece per package

● : Line-up

DMF Flat geometry head

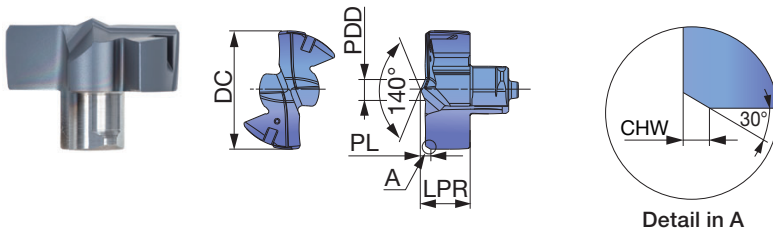

Tool diameter	Head diameter tolerance
ø6 - ø17.9	+0.018 / 0
ø18 - ø19.9	+0.021 / 0

Detail in A

P	Steel	★		
M	Stainless	★		
K	Cast iron	★		
N	Non-ferrous	☆		
S	Superalloys	★		
H	Hard materials	★		

P	Steel	★		
M	Stainless	★		
K	Cast iron	★		
N	Non-ferrous	☆		
S	Superalloys	★		
H	Hard materials	★		

★ : First choice
☆ : Second choice

Designation	DC	LPR	Coated		CHW	PL	PDD	Body
			AH9130					
DMF060	6	3.01	●		0.4	0.61	1.15	TID*060...
DMF065	6.5	3.28	●		0.4	0.68	1.54	TID*065...
DMF068	6.8	3.28	●		0.4	0.68	1.54	TID*065...
DMF070	7	3.58	●		0.4	0.68	1.54	TID*070...
DMF075	7.5	3.58	●		0.4	0.68	1.54	TID*075...
DMF080	8	4.39	●		0.7	1.09	2.44	TID*080...
DMF081	8.1	4.39	●		0.7	1.09	2.44	TID*080...
DMF085	8.5	4.39	●		0.7	1.09	2.44	TID*085...
DMF086	8.6	4.39	●		0.7	1.09	2.44	TID*085...
DMF087	8.7	4.39	●		0.7	1.09	2.44	TID*085...
DMF088	8.8	4.39	●		0.7	1.09	2.44	TID*085...
DMF090	9	4.61	●		0.7	1.11	2.55	TID*090...
DMF095	9.5	4.61	●		0.7	1.11	2.55	TID*095...
DMF100	10	4.72	●		0.7	1.17	2.89	TID*100...
DMF101	10.1	4.72	●		0.7	1.17	2.89	TID*100...
DMF103	10.3	4.72	●		0.7	1.17	2.89	TID*100...
DMF104	10.4	4.72	●		0.7	1.17	2.89	TID*100...
DMF105	10.5	4.72	●		0.7	1.17	2.89	TID*105...
DMF106	10.6	4.72	●		0.7	1.17	2.89	TID*105...
DMF107	10.7	4.72	●		0.7	1.17	2.89	TID*105...
DMF108	10.8	4.72	●		0.7	1.17	2.89	TID*105...
DMF110	11	4.9	●		0.7	1.25	2.98	TID*110...
DMF115	11.5	4.9	●		0.7	1.25	2.98	TID*115...
DMF117	11.7	4.9	●		0.7	1.25	2.98	TID*115...
DMF120	12	5.21	●		0.7	1.26	3.13	TID*120...
DMF121	12.1	5.21	●		0.7	1.26	3.13	TID*120...
DMF122	12.2	5.21	●		0.7	1.26	3.13	TID*120...
DMF123	12.3	5.21	●		0.7	1.26	3.13	TID*120...
DMF124	12.4	5.21	●		0.7	1.26	3.13	TID*120...
DMF125	12.5	5.21	●		0.7	1.26	3.13	TID*125...
DMF126	12.6	5.21	●		0.7	1.26	3.13	TID*125...
DMF127	12.7	5.21	●		0.7	1.26	3.13	TID*125...
DMF130	13	5.53	●		0.7	1.28	3.52	TID*130...
DMF131	13.1	5.53	●		0.7	1.28	3.52	TID*130...
DMF133	13.3	5.53	●		0.7	1.28	3.52	TID*130...
DMF135	13.5	5.53	●		0.7	1.28	3.52	TID*135...
DMF137	13.7	5.53	●		0.7	1.28	3.52	TID*135...
DMF138	13.8	5.53	●		0.7	1.28	3.52	TID*135...
DMF139	13.9	5.53	●		0.7	1.28	3.52	TID*135...

ø6 - ø19.9 = 2 pieces per package
ø20 - ø25.9 = 1 piece per package

Designation	DC	LPR	Coated		CHW	PL	PDD	Body
			AH9130					
DMF140	14	5.96	●		0.7	1.31	3.81	TID*140...
DMF141	14.1	5.96	●		0.7	1.31	3.81	TID*140...
DMF142	14.2	5.96	●		0.7	1.31	3.81	TID*140...
DMF143	14.3	5.96	●		0.7	1.31	3.81	TID*140...
DMF144	14.4	5.96	●		0.7	1.31	3.81	TID*140...
DMF145	14.5	5.96	●		0.7	1.31	3.81	TID*145...
DMF150	15	6.43	●		0.7	1.35	4.24	TID*150...
DMF152	15.2	6.43	●		0.7	1.35	4.24	TID*150...
DMF155	15.5	6.43	●		0.7	1.35	4.24	TID*150...
DMF157	15.7	6.43	●		0.7	1.35	4.24	TID*150...
DMF158	15.8	6.43	●		0.7	1.35	4.24	TID*150...
DMF160	16	6.84	●		0.7	1.39	4.06	TID*160...
DMF161	16.1	6.84	●		0.7	1.39	4.06	TID*160...
DMF165	16.5	6.84	●		0.7	1.39	4.06	TID*160...
DMF167	16.7	6.84	●		0.7	1.39	4.06	TID*160...
DMF170	17	7.15	●		0.7	1.4	4.14	TID*170...
DMF175	17.5	7.15	●		0.7	1.4	4.14	TID*170...
DMF179	17.9	7.15	●		0.7	1.4	4.14	TID*170...
DMF180	18	7.45	●		0.7	1.42	4.16	TID*180...
DMF185	18.5	7.45	●		0.7	1.42	4.16	TID*180...
DMF190	19	7.79	●		0.7	1.44	4.25	TID*190...
DMF195	19.5	7.79	●		0.7	1.44	4.25	TID*190...
DMF198	19.8	7.79	●		0.7	1.44	4.25	TID*190...
DMF200	20	9.12	●		0.7	1.77	6.56	TID*200...
DMF205	20.5	9.12	●		0.7	1.77	6.56	TID*200...
DMF210	21	9.54	●		0.7	1.79	6.92	TID*210...
DMF215	21.5	9.54	●		0.7	1.79	6.92	TID*210...
DMF218	21.8	9.54	●		0.7	1.79	6.92	TID*210...
DMF220	22	9.86	●		0.7	1.81	7.13	TID*220...
DMF225	22.5	9.86	●		0.7	1.81	7.13	TID*220...
DMF230	23	10.28	●		0.7	1.83	7.42	TID*230...
DMF235	23.5	10.28	●		0.7	1.83	7.42	TID*230...
DMF240	24	10.71	●		0.7	1.86	7.45	TID*240...
DMF245	24.5	10.71	●		0.7	1.86	7.45	TID*240...
DMF250	25	11.15	●		0.7	1.9	7.54	TID*250...
DMF254	25.4	11.15	●		0.7	1.9	7.54	TID*250...
DMF255	25.5	11.15	●		0.7	1.9	7.54	TID*250...
DMF259	25.9	11.15	●		0.7	1.9	7.54	TID*250...

● : Will be released in January 2022

● : Line-up

DMH High strength cutting edge

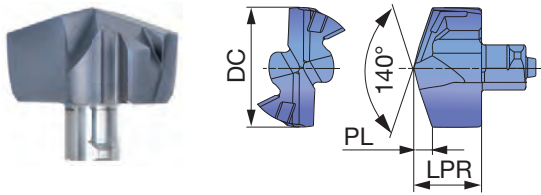

Tool diameter	Head diameter tolerance
ø10 - ø19.5	±0.01

P	Steel	★			
M	Stainless	★			
K	Cast iron	★			
N	Non-ferrous	☆			
S	Superalloys	★			
H	Hard materials	★			

★ : First choice
☆ : Second choice

Designation	DC	LPR	Coated		PL	Body
			AH9130			
DMH100	10	6.05	●		1.47	TID*100...
DMH103	10.3	6.05	●		1.52	TID*100...
DMH105	10.5	6.05	●		1.56	TID*105...
DMH108	10.8	6.05	●		1.62	TID*105...
DMH110	11	6.45	●		1.67	TID*110...
DMH115	11.5	6.45	●		1.76	TID*115...
DMH120	12	6.8	●		1.82	TID*120...
DMH125	12.5	6.8	●		1.91	TID*125...
DMH126	12.6	6.8	●		1.93	TID*125...
DMH130	13	7.4	●		1.96	TID*130...
DMH133	13.3	7.4	●		2.01	TID*130...
DMH135	13.5	7.4	●		2.05	TID*135...
DMH137	13.7	7.4	●		2.09	TID*135...
DMH138	13.8	7.4	●		2.11	TID*135...
DMH139	13.9	7.4	●		2.12	TID*135...
DMH140	14	7.95	●		2.12	TID*140...
DMH142	14.2	7.95	●		2.16	TID*140...
DMH145	14.5	7.95	●		2.21	TID*145...
DMH150	15	8.53	●		2.27	TID*150...
DMH152	15.2	8.53	●		2.31	TID*150...
DMH155	15.5	8.53	●		2.36	TID*150...
DMH160	16	9.1	●		2.42	TID*160...
DMH165	16.5	9.1	●		2.51	TID*160...
DMH170	17	9.7	●		2.59	TID*170...
DMH175	17.5	9.7	●		2.68	TID*170...
DMH180	18	10.3	●		2.73	TID*180...
DMH185	18.5	10.3	●		2.82	TID*180...
DMH190	19	10.8	●		2.88	TID*190...
DMH194	19.4	10.8	●		2.95	TID*190...
DMH195	19.5	10.8	●		2.97	TID*190...

ø10 - ø19.5 = 2 pieces per package

● : Line-up

DMN Non-ferrous metals drilling

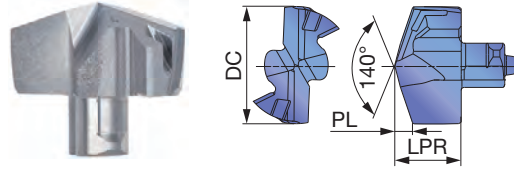

Tool diameter	Head diameter tolerance
ø10 - ø17.5	+0.01 / 0
ø18 - ø19.9	+0.012 / 0

P	Steel				
M	Stainless				
K	Cast iron				
N	Non-ferrous	★			
S	Superalloys				
H	Hard materials				

★ : First choice
☆ : Second choice





Designation	DC	LPR	Coated		PL	Body
			KS15F			
DMN100	10	6.05	●		1.47	TID*100...
DMN102	10.2	6.05	●		1.51	TID*100...
DMN105	10.5	6.05	●		1.56	TID*105...
DMN108	10.8	6.05	●		1.62	TID*105...
DMN110	11	6.45	●		1.67	TID*110...
DMN115	11.5	6.45	●		1.76	TID*115...
DMN120	12	6.8	●		1.82	TID*120...
DMN123	12.3	6.8	●		1.87	TID*120...
DMN125	12.5	6.8	●		1.91	TID*125...
DMN126	12.6	6.8	●		1.93	TID*125...
DMN127	12.7	6.8	●		1.95	TID*125...
DMN130	13	7.4	●		1.96	TID*130...
DMN135	13.5	7.4	●		2.05	TID*135...
DMN138	13.8	7.4	●		2.11	TID*135...
DMN140	14	7.95	●		2.12	TID*140...
DMN142	14.2	7.95	●		2.16	TID*140...
DMN145	14.5	7.95	●		2.21	TID*145...
DMN150	15	8.53	●		2.27	TID*150...
DMN152	15.2	8.53	●		2.31	TID*150...
DMN155	15.5	8.53	●		2.36	TID*150...
DMN158	15.8	8.53	●		2.42	TID*150...
DMN159	15.9	8.53	●		2.43	TID*150...
DMN160	16	9.1	●		2.42	TID*160...
DMN163	16.3	9.1	●		2.47	TID*160...
DMN165	16.5	9.1	●		2.51	TID*160...
DMN170	17	9.7	●		2.59	TID*170...
DMN175	17.5	9.7	●		2.68	TID*170...
DMN180	18	10.3	●		2.73	TID*180...
DMN185	18.5	10.3	●		2.82	TID*180...
DMN190	19	10.8	●		2.88	TID*190...
DMN195	19.5	10.8	●		2.97	TID*190...

ø10 - ø19.5 = 2 pieces per package

● : Line-up



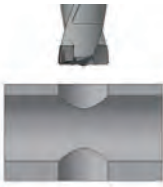

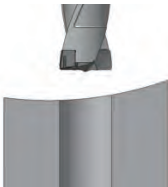
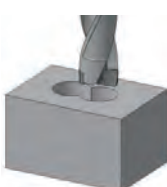
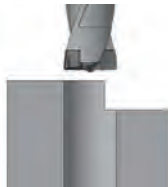

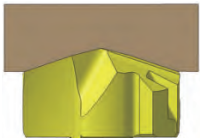

APPLICATION RANGE AND RECOMMENDED TOOL LENGTHS FOR DMF HEAD

Please use the shortest possible tool

Recommended L/D	≤ 8			
Application	Plane surface	Complex exit	Cross hole	Rough / cast surface
				
	≤ 3		≤ 1.5	
	Slant surface	Round surface	Hole expansion	Plunging
Application				

- Maximum slant angle 12 degrees
- Feed rate should be decreased when drilling uneven surfaces
- Overlap should be under 30% of head dia. at hole expansion
- Plunging width should be 70% of head dia.

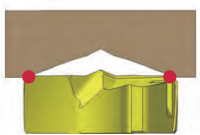
HEAD COMBINATIONS OF PRE-HOLE TO MAIN HOLE

		Pre-hole		
		DMP	DMC	DMF
Hole	DMP	Good 	Not good 	Not good 
	DMC	Good 	Good 	Good 
	DMF	Not good 	Not good 	Good 

STANDARD CUTTING CONDITIONS

ISO	Workpiece material	Cutting speed Vc (m/min)	Feed: f (mm/rev)						
			DC (mm)						
			ø6 - 7.9	ø8 - 9.9	ø10 - ø11.9	ø12 - ø13.9	ø14 - ø15.9	ø16 - ø19.9	ø20 - ø25.9
P	Low carbon steels (C < 0.3) SS400, SM490, S25C, etc. C15E4, E275A, E355D, etc.	80 - 140	0.09 - 0.13	0.12 - 0.25	0.15 - 0.28	0.18 - 0.3	0.20 - 0.35	0.25 - 0.45	0.25 - 0.45
	High carbon steels (C > 0.3) S45C, S55C, etc. C45, C55, etc.	70 - 120	0.09 - 0.13	0.12 - 0.25	0.15 - 0.28	0.18 - 0.3	0.2 - 0.35	0.25 - 0.45	0.25 - 0.45
	Low alloy steels SCM415, etc. 18CrMo4, etc.	70 - 120	0.08 - 0.13	0.11 - 0.25	0.14 - 0.28	0.16 - 0.32	0.18 - 0.35	0.23 - 0.4	0.25 - 0.45
	Alloy steels SCM440, SCr420, etc. 42CrMo4, 20Cr4, etc.	40 - 90	0.08 - 0.13	0.11 - 0.25	0.14 - 0.28	0.16 - 0.32	0.18 - 0.35	0.23 - 0.4	0.25 - 0.45
M	Stainless steels SUS304, SUS316, etc. X5CrNi18-9, X5CrNiMo17-12-2, etc.	30 - 70	0.08 - 0.1	0.1 - 0.15	0.12 - 0.18	0.14 - 0.2	0.16 - 0.24	0.16 - 0.26	0.18 - 0.3
K	Grey cast irons FC250, etc. GG25, etc.	80 - 180	0.12 - 0.18	0.15 - 0.3	0.20 - 0.35	0.25 - 0.4	0.3 - 0.45	0.35 - 0.55	0.35 - 0.6
	Ductile cast irons FCD700, etc. GGG70, etc.	80 - 140	0.12 - 0.18	0.15 - 0.3	0.20 - 0.35	0.25 - 0.4	0.3 - 0.45	0.35 - 0.55	0.35 - 0.6
N	Aluminium alloys ADC12, etc. AlSi11Cu3, etc.	80 - 220	0.1 - 0.2	0.2 - 0.35	0.25 - 0.4	0.3 - 0.45	0.35 - 0.5	0.4 - 0.6	0.5 - 0.75
S	Titanium alloys Ti-6Al-4V, etc.	20 - 50	0.05 - 0.07	0.06 - 0.12	0.08 - 0.15	0.1 - 0.28	0.12 - 0.2	0.14 - 0.22	0.18 - 0.27
	Nickel-based alloys	20 - 50	0.05 - 0.07	0.06 - 0.11	0.08 - 0.13	0.1 - 0.15	0.12 - 0.18	0.12 - 0.22	0.14 - 0.22
H	Hardened steel	20 - 50	0.05 - 0.07	0.06 - 0.12	0.08 - 0.15	0.1 - 0.18	0.12 - 0.2	0.14 - 0.22	0.16 - 0.25

- Cutting conditions in the above table show standard cutting conditions
- Cutting conditions may change due to the rigidity and power of the machine and the workpiece material

- Machined hole diameter may change depending upon the rigidity of the machine tool or cutting conditions
- In case of L/D = 8,12 drill, the recommended range of cutting speeds and feeds is between the minimum and median values listed above

SOLID ^{FLUTES} 4 DRILL

Drilling

4-FLUTE SOLID DRILLS FOR EXCEPTIONAL PERFORMANCE

ADD 4 cutting edges for highly productive drilling
and longer tool life





- Optimal cutting edge and flute profiles promotes smooth chip evacuation.
- Self-centering cutting edge style provides secure drill engagement.
- 4 margins on the drill periphery provides close tolerance holes.

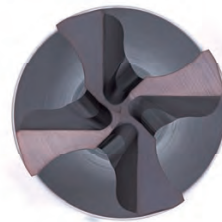

Lineup

Drill

- **DSQ...**

4 flutes drill

DC = $\varnothing 6$ - $\varnothing 16$ mm

Available in 3xD and 5xD

Grade

- **AH9130**: Wear-resistant grade that enables long tool life

Scan this QR code
to find out more
about this tool!



SOLID DRILL

DSQ-E3

Solid drill, without coolant hole, DIN shank, L/D = 3, $\phi 6 - \phi 16$ mm

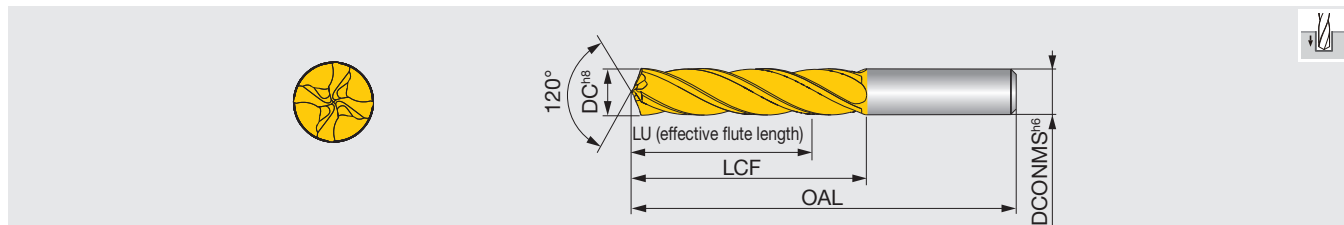

Designation	DC	AH9130	DCONMS	LU	LCF	OAL	Designation	DC	AH9130	DCONMS	LU	LCF	OAL
DSQ060-018-06E3	6	●	6	24	30	80	DSQ108-033-11E3	10.8	●	11	43	54	124
DSQ068-021-07E3	6.8	●	7	27	34	84	DSQ120-036-12E3	12	●	12	48	60	130
DSQ085-026-09E3	8.5	●	9	34	43	93	DSQ130-039-13E3	13	●	13	52	65	135
DSQ090-027-09E3	9	●	9	36	45	95	DSQ140-042-14E3	14	●	14	56	70	140
DSQ100-030-10E3	10	●	10	40	50	100	DSQ160-048-16E3	16	●	16	64	80	150
DSQ105-032-11E3	10.5	●	11	42	53	123							

● : New

DSQ-E5

Solid drill, without coolant hole, DIN shank, L/D = 5, $\phi 6 - \phi 16$ mm

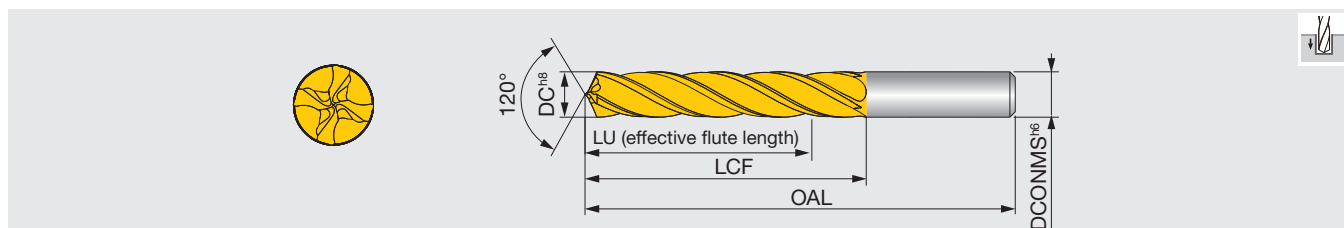

Designation	DC	AH9130	DCONMS	LU	LCF	OAL	Designation	DC	AH9130	DCONMS	LU	LCF	OAL
DSQ060-030-06E5	6	●	6	36	42	92	DSQ105-053-11E5	10.5	●	11	63	74	144
DSQ068-034-07E5	6.8	●	7	41	48	98	DSQ120-060-12E5	12	●	12	72	84	154
DSQ085-043-09E5	8.5	●	9	51	60	110	DSQ160-080-16E5	16	●	16	96	112	182

● : New

STANDARD CUTTING CONDITIONS

ISO	Workpiece material	Brinell hardness (HB)	Cutting speed Vc (m/min)	Feed: f (mm/rev)	
				ø6 ~ ø9.9	ø10 ~ ø16
K	Grey cast irons FC300, etc. 250, etc.	~ 200	60 - 120	0.2 - 0.8	0.3 - 1
	Ductile cast irons FCD450, etc. 450-10S, etc.	~ 300	60 - 120	0.2 - 0.8	0.3 - 1

- The cutting parameters shown in the table are a starting guideline. Values should be varied depending on the power or rigidity of the machine. Optimum conditions should be selected depending on the actual chip control or damage on edges.
- When using the smaller diameter tools in each range, set the feed "f" to the lower values.
- When drilling with a depth deeper than L/D = 3, a pecking cycle or dwell operation should be considered depending on the actual chip control.

REAMMEISTER

Reaming

EXCHANGEABLE HEAD REAMERS FOR MAXIMUM PRODUCTIVITY AND HIGH PRECISION

ADD exchangeable head solutions for precision reaming operations

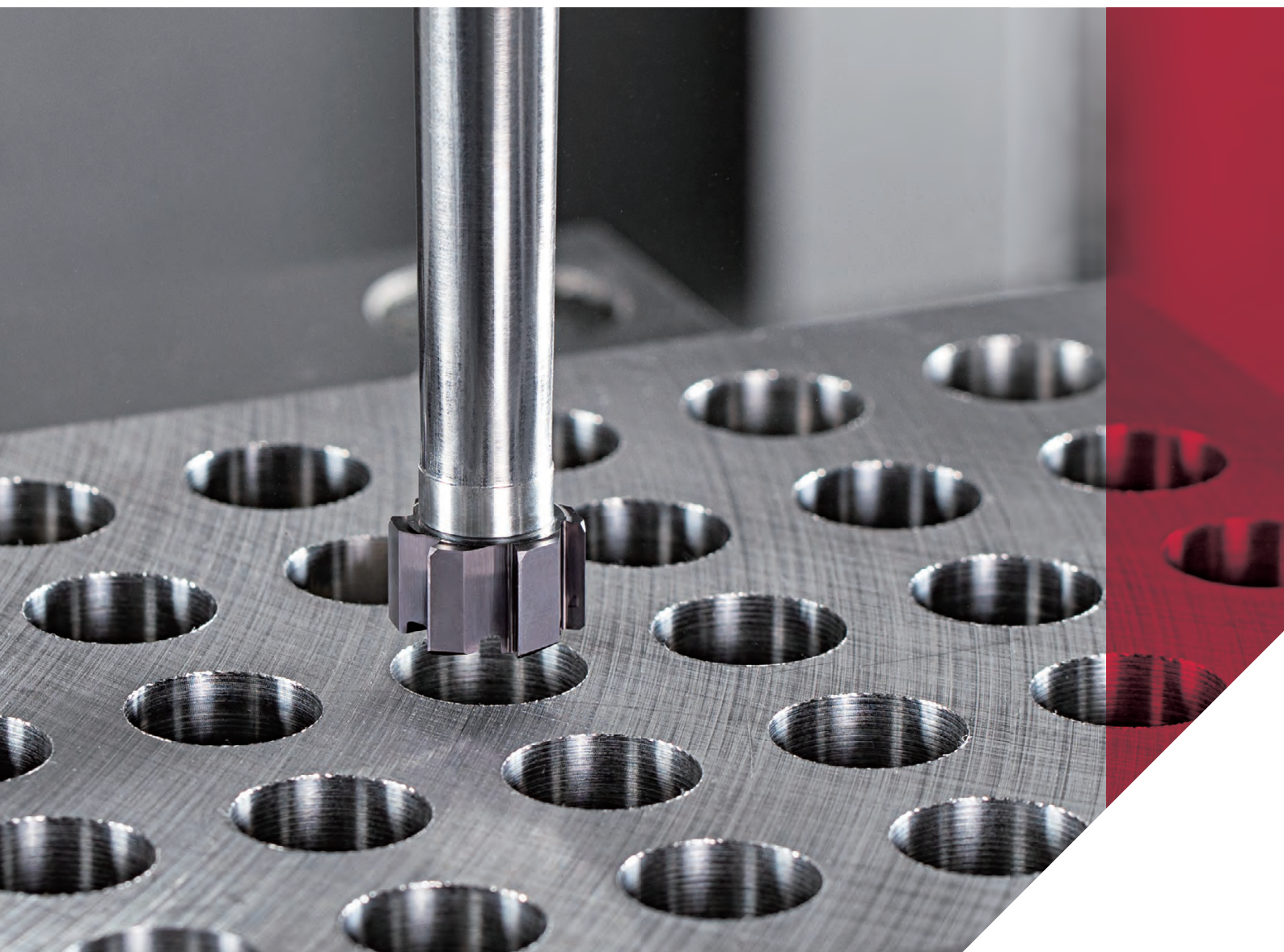



- High precision coupling of the head and shank enables exceptional runout accuracy and repeatability.
- Precision-ground reaming heads enable high precision tolerance of H7.
- Two types of reaming heads are available for blind or through holes.
- Optimized cutting edge geometries for long tool life and wear predictability.
- Available in versatile **AH725** grade, allowing high speed and efficiency machining.

Lineup

Heads

- HRM...

AS type: for blind holes

BL type: for through holes

DC = \varnothing 11.501 - \varnothing 32 mm

Reamer body

- TRM: Straight shank

Available in 1.5D, 3D, 5D, and 8D

Grade

- **AH725:** Versatile grade for all material groups

Scan this QR code
to find out more
about this tool!



REAMER TOOL

TRM

Reamer tool

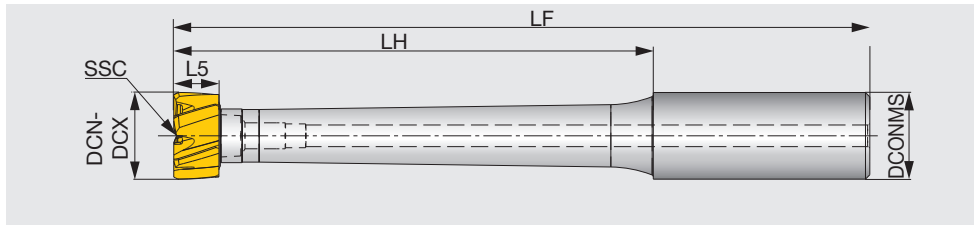

Designation	DCN	DCX	SSC	L/D	DCONMS	L5	LF	LH
TRM-T5-R16-1.5	11.5	13.5	T5	1.5	16	9.3	77.8	29.8
TRM-T6-R16-1.5	13.501	16	T6	1.5	16	9.4	81.5	33.5
TRM-T7-R20-1.5	16.001	20	T7	1.5	20	10.6	90.7	40.7
TRM-T8-R20-1.5	20.001	25.999	T8	1.5	20	12.8	101	51
TRM-T9-R32-1.5	26	32	T9	1.5	32	12.8	120.9	60.9
TRM-T5-R16-3	11.5	13.5	T5	3	16	9.3	97.8	49.8
TRM-T6-R16-3	13.501	16	T6	3	16	9.4	105.4	57.4
TRM-T7-R20-3	16.001	20	T7	3	20	10.6	120.6	70.6
TRM-T8-R20-3	20.001	25.999	T8	3	20	12.8	137.8	87.8
TRM-T9-R32-3	26	32	T9	3	32	12.8	167.1	107.1
TRM-T5-R16-5	11.5	13.5	T5	5	16	9.3	125	77
TRM-T6-R16-5	13.501	16	T6	5	16	9.4	137.4	89.4
TRM-T7-R20-5	16.001	20	T7	5	20	10.6	160.6	110.6
TRM-T8-R20-5	20.001	25.999	T8	5	20	12.8	187.8	137.8
TRM-T9-R32-5	26	32	T9	5	32	12.8	231.1	171.1
TRM-T5-R16-8	11.5	13.5	T5	8	16	9.3	165.5	117.5
TRM-T6-R16-8	13.501	16	T6	8	16	9.4	185.4	137.4
TRM-T7-R20-8	16.001	20	T7	8	20	10.6	220.6	170.6
TRM-T8-R20-8	20.001	25.999	T8	8	20	12.8	262.8	212.8
TRM-T9-R32-8	26	32	T9	8	32	12.8	327.1	267.1
TRMU-T5-R0.625-1.5	11.5	13.5	T5	1.5	15.875	9.3	77.7	29.7
TRMU-T6-R0.625-1.5	13.501	16	T6	1.5	15.875	9.4	81.5	33.5
TRMU-T7-R0.75-1.5	16.001	20	T7	1.5	19.05	10.6	90.7	40.6
TRMU-T8-R0.75-1.5	20.001	25.999	T8	1.5	19.05	12.8	101.1	51.1
TRMU-T9-R1.25-1.5	26	32	T9	1.5	31.75	12.8	120.9	61.0
TRMU-T5-R0.625-3	11.5	13.5	T5	3	15.875	9.3	97.8	49.8
TRMU-T6-R0.625-3	13.501	16	T6	3	15.875	9.4	105.4	57.4
TRMU-T7-R0.75-3	16.001	20	T7	3	19.05	10.6	120.4	70.6
TRMU-T8-R0.75-3	20.001	25.999	T8	3	19.05	12.8	137.7	87.6
TRMU-T9-R1.25-3	26	32	T9	3	31.75	12.8	167.1	106.9
TRMU-T5-R0.625-5	11.5	13.5	T5	5	15.875	9.3	125.0	77.0
TRMU-T6-R0.625-5	13.501	16	T6	5	15.875	9.4	137.4	89.4
TRMU-T7-R0.75-5	16.001	20	T7	5	19.05	10.6	160.5	110.5
TRMU-T8-R0.75-5	20.001	25.999	T8	5	19.05	12.8	187.7	137.7
TRMU-T9-R1.25-5	26	32	T9	5	31.75	12.8	231.1	171.2
TRMU-T5-R0.625-8	11.5	13.5	T5	8	15.875	9.3	165.4	117.3
TRMU-T6-R0.625-8	13.501	16	T6	8	15.875	9.4	185.4	137.4
TRMU-T7-R0.75-8	16.001	20	T7	8	19.05	10.6	220.5	170.7
TRMU-T8-R0.75-8	20.001	25.999	T8	8	19.05	12.8	262.9	212.9
TRMU-T9-R1.25-8	26	32	T9	8	31.75	12.8	327.2	267.0

•Key and screw are included.

•Maximum effective reaming depth = Head diameter(mm) x L/D ratio.

Ex. For a reamer with $\phi 12$ mm: $12 \text{ mm} \times 3D = 36 \text{ mm}$

REAMER HEAD

HRM-AS (for blind holes)

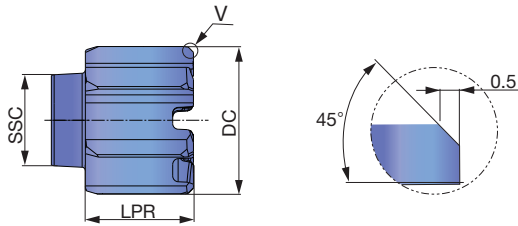

HRM-BL (for through holes)

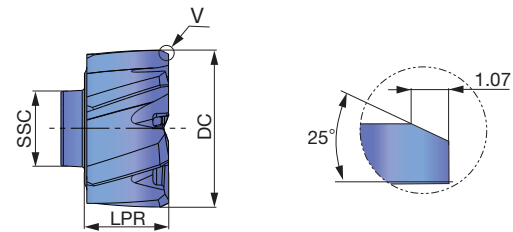

Designation	DC	AH725	SSC	LPR	CICT
HRM-11.501-AS-T5	11.501	●	T5	9.3	6
HRM-12.000-AS-T5	12	●	T5	9.3	6
HRM-12.700-AS-T5	12.7	●	T5	9.3	6
HRM-13.000-AS-T5	13	●	T5	9.3	6
HRM-13.500-AS-T5	13.5	●	T5	9.3	6
HRM-14.000-AS-T6	14	●	T6	9.4	6
HRM-15.000-AS-T6	15	●	T6	9.4	6
HRM-15.875-AS-T6	15.875	●	T6	9.4	6
HRM-16.000-AS-T6	16	●	T6	9.4	6
HRM-16.001-AS-T7	16.001	●	T7	10.6	6
HRM-17.000-AS-T7	17	●	T7	10.6	6
HRM-18.000-AS-T7	18	●	T7	10.6	6
HRM-19.000-AS-T7	19	●	T7	10.6	6
HRM-19.050-AS-T7	19.05	●	T7	10.6	6
HRM-20.000-AS-T7	20	●	T7	10.6	6
HRM-20.001-AS-T8	20.001	●	T8	12.8	8
HRM-21.000-AS-T8	21	●	T8	12.8	8
HRM-22.000-AS-T8	22	●	T8	12.8	8
HRM-23.000-AS-T8	23	●	T8	12.8	8
HRM-24.000-AS-T8	24	●	T8	12.8	8
HRM-25.000-AS-T8	25	●	T8	12.8	8
HRM-25.400-AS-T8	25.4	●	T8	12.8	8
HRM-26.000-AS-T9	26	●	T9	12.8	8
HRM-27.000-AS-T9	27	●	T9	12.8	8
HRM-28.000-AS-T9	28	●	T9	12.8	8
HRM-29.000-AS-T9	29	●	T9	12.8	8
HRM-30.000-AS-T9	30	●	T9	12.8	8
HRM-31.000-AS-T9	31	●	T9	12.8	8
HRM-31.750-AS-T9	31.75	●	T9	12.8	8
HRM-32.000-AS-T9	32	●	T9	12.8	8

Designation	DC	AH725	SSC	LPR	CICT
HRM-11.501-BL-T5	11.501	●	T5	9.3	6
HRM-12.000-BL-T5	12	●	T5	9.3	6
HRM-12.700-BL-T5	12.7	●	T5	9.3	6
HRM-13.000-BL-T5	13	●	T5	9.3	6
HRM-13.500-BL-T5	13.5	●	T5	9.3	6
HRM-13.501-BL-T6	13.501	●	T6	9.4	6
HRM-14.000-BL-T6	14	●	T6	9.4	6
HRM-15.000-BL-T6	15	●	T6	9.4	6
HRM-15.875-BL-T6	15.875	●	T6	9.4	6
HRM-16.000-BL-T6	16	●	T6	9.4	6
HRM-16.001-BL-T7	16.001	●	T7	10.6	6
HRM-17.000-BL-T7	17	●	T7	10.6	6
HRM-18.000-BL-T7	18	●	T7	10.6	6
HRM-19.000-BL-T7	19	●	T7	10.6	6
HRM-19.050-BL-T7	19.05	●	T7	10.6	6
HRM-20.000-BL-T7	20	●	T7	10.6	6
HRM-20.001-BL-T8	20.001	●	T8	12.8	8
HRM-21.000-BL-T8	21	●	T8	12.8	8
HRM-22.000-BL-T8	22	●	T8	12.8	8
HRM-23.000-BL-T8	23	●	T8	12.8	8
HRM-24.000-BL-T8	24	●	T8	12.8	8
HRM-25.000-BL-T8	25	●	T8	12.8	8
HRM-25.400-BL-T8	25.4	●	T8	12.8	8
HRM-26.000-BL-T9	26	●	T9	12.8	8
HRM-27.000-BL-T9	27	●	T9	12.8	8
HRM-28.000-BL-T9	28	●	T9	12.8	8
HRM-29.000-BL-T9	29	●	T9	12.8	8
HRM-30.000-BL-T9	30	●	T9	12.8	8
HRM-31.000-BL-T9	31	●	T9	12.8	8
HRM-32.000-BL-T9	32	●	T9	12.8	8

Head diameter range	Tolerance range of the head	Hole diameter tolerance (H7)
ø11.500 - ø18.000	+0.015 / +0.011	+0.018 / 0
ø18.001 - ø30.000	+0.017 / +0.013	+0.021 / 0
ø30.001 - ø32.000	+0.021 / +0.016	+0.025 / 0

● : Line-up
Package quantity = 1 pcs.

Head diameter range	Tolerance range of the head	Hole diameter tolerance (H7)
ø11.500 - ø18.000	+0.015 / +0.011	+0.018 / 0
ø18.001 - ø30.000	+0.017 / +0.013	+0.021 / 0
ø30.001 - ø32.000	+0.021 / +0.016	+0.025 / 0

● : Line-up
Package quantity = 1 pcs.

- All standard heads are designed to achieve H7 hole tolerance.
- Head diameters are produced so that the hole diameter achieved is close to the max tolerance limit.

- All standard heads are designed to achieve H7 hole tolerance.
- Head diameters are produced so that the hole diameter achieved is close to the max tolerance limit.

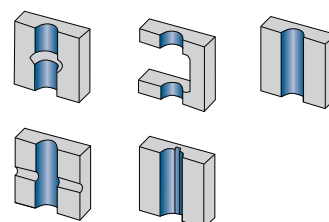
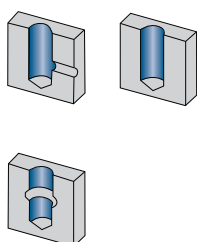

STANDARD CUTTING CONDITIONS

Conversion table for feed per tooth

ISO	Workpiece materials	Cutting speed Vc (m/min)	Feed: fz(mm/t)			
			AS: Straight flute (for blind holes)		BL: Left hand flute (for through holes)	
			Ø11.5 - Ø16	Ø16 - Ø32	Ø11.5 - Ø16	Ø16 - Ø32
P	Low carbon steel (C<0.3) SS400, SM490, S25C, E275A, etc.	80 - 200	0.05 - 0.18	0.05 - 0.20	0.05 - 0.2	0.05 - 0.27
	Carbon steel (C>0.3) S45C, S55C, C45, C55, etc.	80 - 150	0.05 - 0.15	0.05 - 0.18	0.05 - 0.18	0.05 - 0.25
	Low alloy steel (C<0.3) SCM415, etc.	80 - 200	0.05 - 0.18	0.05 - 0.20	0.05 - 0.2	0.05 - 0.27
	Alloy steel (C>0.3) SCM440, SCr420, 42CrMo4, 20Cr4, etc.	50 - 150	0.03 - 0.10	0.05 - 0.13	0.05 - 0.13	0.05 - 0.17
M	Stainless steel (Austenitic) SUS304, SUS316, X5CrNi18-9, X5CrNiMo17-12-3, etc.	20 - 40	0.03 - 0.10	0.03 - 0.13	0.05 - 0.13	0.05 - 0.17
	Stainless steel (Martensitic and ferritic) SUS430, SUS416, X6Cr17, etc.	20 - 40	0.03 - 0.10	0.03 - 0.13	0.05 - 0.13	0.05 - 0.17
	Stainless steel (Precipitation hardening) SUS630, X5CrNiCuNb16-4, etc.	20 - 40	0.03 - 0.10	0.03 - 0.13	0.05 - 0.13	0.05 - 0.17
K	Gray cast iron FC250, GG25, 250, etc.	100 - 250	0.05 - 0.18	0.05 - 0.20	0.05 - 0.2	0.05 - 0.27
	Ductile cast iron FCD700, etc.	80 - 200	0.05 - 0.15	0.05 - 0.18	0.05 - 0.18	0.05 - 0.25
N	Aluminum alloy	100 - 300	0.05 - 0.18	0.05 - 0.20	0.05 - 0.2	0.05 - 0.27
S	High temp. alloy Inconel718, etc.	15 - 50	0.03 - 0.06	0.03 - 0.08	0.05 - 0.1	0.05 - 0.13
	Titanium alloy Ti-6Al-4V, etc.	30 - 60	0.03 - 0.10	0.03 - 0.13	0.05 - 0.13	0.05 - 0.17
H	Hardened steel Over 40HRC, etc.	50 - 100	0.03-0.08	0.03 - 0.1	0.05-0.12	0.05 - 0.15

Conversion table for feed per revolution

ISO	Workpiece materials	Cutting speed Vc (m/min)	Feed: f (mm/rev)					
			AS: Straight flute (for blind holes)			BL: Left hand flute (for through holes)		
			Ø11.5 - Ø16 6 flutes	Ø16.001 - Ø20 6 flutes	Ø20.001 - Ø32 8 flutes	Ø11.5 - Ø16 6 flutes	Ø16.001 - Ø20 6 flutes	Ø20.001 - Ø32 8 flutes
P	Low carbon steel (C<0.3) SS400, SM490, S25C, E275A, etc.	80 - 200	0.3 - 1.08	0.3 - 1.2	0.4 - 1.6	0.3 - 1.2	0.3 - 1.62	0.4 - 2.16
	Carbon steel (C>0.3) S45C, S55C, C45, C55, etc.	80 - 150	0.3 - 0.9	0.3 - 1.08	0.4 - 1.44	0.3 - 1.08	0.3 - 1.5	0.4 - 2
	Low alloy steel (C<0.3) SCM415, etc.	80 - 200	0.3 - 1.08	0.3 - 1.2	0.4 - 1.6	0.3 - 1.2	0.3 - 1.2	0.4 - 2.16
	Alloy steel (C>0.3) SCM440, SCr420, 42CrMo4, 20Cr4, etc.	50 - 150	0.18 - 0.6	0.3 - 0.78	0.4 - 1.04	0.3 - 0.78	0.3 - 1.02	0.4 - 1.36
M	Stainless steel (Austenitic) SUS304, SUS316, X5CrNi18-9, X5CrNiMo17-12-3, etc.	20 - 40	0.18 - 0.6	0.18 - 0.78	0.24 - 1.04	0.3 - 0.78	0.3 - 1.02	0.4 - 1.36
	Stainless steel (Martensitic and ferritic) SUS430, SUS416, X6Cr17, etc.	20 - 40	0.18 - 0.6	0.18 - 0.78	0.24 - 1.04	0.3 - 0.78	0.3 - 1.02	0.4 - 1.36
	Stainless steel (Precipitation hardening) SUS630, X5CrNiCuNb16-4, etc.	20 - 40	0.18 - 0.6	0.18 - 0.78	0.24 - 1.04	0.3 - 0.78	0.3 - 1.02	0.4 - 1.36
K	Gray cast iron FC250, GG25, 250, etc.	100 - 250	0.3 - 1.08	0.3 - 1.2	0.4 - 1.6	0.3 - 1.2	0.3 - 1.62	0.4 - 2.16
	Ductile cast iron FCD700, etc.	80 - 200	0.3 - 0.9	0.3 - 1.08	0.4 - 1.44	0.3 - 1.8	0.3 - 1.62	0.4 - 2
N	Aluminum alloy	100 - 300	0.3 - 1.08	0.3 - 1.2	0.4 - 1.6	0.3 - 1.2	0.3 - 1.62	0.4 - 2.16
S	High temp. alloy Inconel718, etc.	15 - 50	0.18 - 0.36	0.18 - 0.48	0.24 - 0.64	0.3 - 0.6	0.3 - 0.78	0.4 - 1.04
	Titanium alloy Ti-6Al-4V, etc.	30 - 60	0.18 - 0.6	0.18 - 0.78	0.24 - 1.04	0.3 - 0.78	0.3 - 1.02	0.4 - 1.36
H	Hardened steel Over 40HRC, etc.	50 - 100	0.18 - 0.48	0.18 - 0.6	0.24 - 0.8	0.3 - 0.72	0.3 - 0.9	0.4 - 1.2

Tungaloy Corporation (Head office)

11-1 Yoshima-Kogyodanchi
Iwaki-city, Fukushima 970-1144 Japan
Phone: +81-246-36-8501
Fax: +81-246-36-8542
www.tungaloy.co.jp

Tungaloy America, Inc.

3726 N Ventura Drive
Arlington Heights, IL 60004, U.S.A.
Phone: +1-888-554-8394
Fax: +1-888-554-8392
www.tungaloy.com/us

Tungaloy Canada

432 Elgin St. Unit 3
Brantford, Ontario N3S 7P7, Canada
Phone: +1-519-758-5779
Fax: +1-519-758-5791
www.tungaloy.com/ca

Tungaloy de Mexico S.A.

C Los Arellano 113,
Parque Industrial Siglo XXI
Aguascalientes, AGS, Mexico 20290
Phone: +52-449-929-5410
Fax: +52-449-929-5411
www.tungaloy.com/mx

Tungaloy do Brasil Ltda.

Avd. Independencia N4158 Residencial Flora
13280-000 Vinhedo, São Paulo, Brasil
Phone: +55-19-38262757
Fax: +55-19-38262757
www.tungaloy.com/br

Tungaloy Germany GmbH

An der Alten Ziegelei 1
D-40789 Monheim, Germany
Phone: +49-2173-90420-0
Fax: +49-2173-90420-19
www.tungaloy.com/de

Tungaloy France S.A.S.

ZA Courtaboef - Le Rio
1 rue de la Terre de feu
F-91952 Courtaboef Cedex, France
Phone: +33-1-6486-4300
Fax: +33-1-6907-7817
www.tungaloy.com/fr

Tungaloy Italia S.r.l.

Via E. Andolfato 10
I-20126 Milano, Italy
Phone: +39-02-252012-1
Fax: +39-02-252012-65
www.tungaloy.com/it

Tungaloy Czech s.r.o.

Turanka 115
CZ-627 00 Brno, Czech Republic
Phone: +420-532 123 391
Fax: +420-532 123 392
www.tungaloy.com/cz

Tungaloy Ibérica S.L.

C/Miquel Servet, 43B, Nau 7
Pol. Ind. Bufalvent
ES-08243 Manresa (BCN), Spain
Phone: +34 93 113 1360
Fax: +34 93 876 2798
www.tungaloy.com/es

Tungaloy Scandinavia AB

Bultgatan 38
442 40 Kungälv, Sweden
Phone: +46-462119200
Fax: +46-462119207
www.tungaloy.com/se

Tungaloy Rus, LLC

Andropova avenue, h.18/7,
11 floor, office 3, 115432,
Moscow, Russia
Phone: +7-499-683-01-80
Fax: +7-499-683-01-81
www.tungaloy.com/ru

Tungaloy Polska Sp. z o.o.

Ul. Irysowa 1, 55-040 Bielany
Wroclawskie, Poland
Phone: +48 607 907 237
www.tungaloy.com/pl

Tungaloy U.K. Ltd

Gallan Park, Watling Street,
Cannock, WS110XG, UK
Phone: +44 121 4000 231
Fax: +44 121 270 9694
www.tungaloy.com/uk

Tungaloy Hungary Kft

Erzsébet királyné útja 125
H-1142 Budapest, Hungary
Phone: +36 1 781-6846
Fax: +36 1 781-6866
www.tungaloy.com/hu

Tungaloy Turkey

Serifali Mah.bayraktar Bulvari Kule Sk. No:26
34775 Umraniye / Istanbul / Turkey
Phone: +90 216 540 04 67
Fax: +90 216 540 04 87
www.tungaloy.com/tr

Tungaloy Benelux b.v.

Tjalk 70
NL-2411 NZ Bodegraven, Netherlands
Phone: +31 172 630 420
Fax: +31 172 630 429
www.tungaloy.com/nl

Tungaloy Croatia

Ulica bana Josipa Jelačića 87,
10430, Samobor, Croatia
Phone: +385 1 3326 604
Fax: +385 1 3327 683
www.tungaloy.com/hr

Tungaloy Cutting Tool (Shanghai) Co.,Ltd.

Rm No 401 No.88 Zhabei
Jiangchang No.3 Rd
Shanghai 200436, China
Phone: +86-21-3632-1880
Fax: +86-21-3621-1918
www.tungaloy.com/cn

Tungaloy Cutting Tools (Taiwan) Co.,Ltd.

9F. No.293, Zhongyang Rd,
Xinzhuang Dist, New Taipei City,
24251 Taiwan
Phone: +886-2-8521-9986
Fax: +886-2-8521-8935
www.tungaloy.com/tw

Tungaloy Cutting Tools (Thailand) Co.,Ltd.

Interlink tower 4th Fl.
1858/5-7 Bangna-Trad Road
km.5 Bangna, Bangna, Bangkok 10260
Thailand
Phone: +66-2-751-5711
Fax: +66-2-751-5715
www.tungaloy.com/th

Tungaloy Singapore (Pte.), Ltd.

62 Ubi Road 1, #06-11 Oxley BizHub 2
Singapore 408734
Phone: +65-6391-1833
Fax: +65-6299-4557
www.tungaloy.com/sg

Tungaloy Vietnam

LE04.38, Lexington Residence
67 Mai Chi Tho St., Dist. 2,
Ho Chi Minh City, Vietnam
Phone: +84-2837406660
www.tungaloy.com/sg

Tungaloy India Pvt. Ltd.

One International Center,
Unit # 902-A, 9th Floor,
Tower 1, Senapati Bapat Marg,
Elphinstone Road (West),
Mumbai -400013, India
Phone: +91-22-6124-8804
Fax: +91-22-6124-8899
www.tungaloy.com/in

Tungaloy Korea Co., Ltd

#1312, Byucksan Digital Valley 5-cha
Beotkot-ro 244, Geumcheon-gu
153-788 Seoul, Korea
Phone: +82-2-2621-6161
Fax: +82-2-6393-8952
www.tungaloy.com/kr

Tungaloy Malaysia Sdn Bhd

50 K-2, Kelana Mall, Jalan SS6/14
Kelana Jaya, 47301
Petaling Jaya, Selangor Darul Ehsan
Malaysia
Phone: +603-7805-3222
Fax: +603-7804-8563
www.tungaloy.com/my

Tungaloy Australia Pty Ltd

Unit 68 1470 Ferntree Gully Road
Knoxfield 3180 Victoria, Australia
Phone: +61-3-9755-8147
Fax: +61-3-9755-6070
www.tungaloy.com/au

PT. Tungaloy Indonesia

Kompleks Grand Wisata Block AA-10
No.3-5 Cibitung
Bekasi 17510, Indonesia
Phone: +62-21-8261-5808
Fax: +62-21-8261-5809
www.tungaloy.com/id



11-1 Yoshima Kogyodanchi
Iwaki 970-1144 Japan
www.tungaloy.com

Distributed by:



 FIND US ON THE CLOUD!
machingcloud.com

Nov. 2021 (TJ)